



PRICE LIST

**LISTINO
PREZZI**
2021

PREISLISTE



CONDIZIONI GENERALI DI VENDITA ITALIA

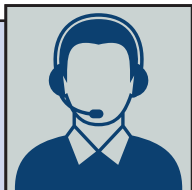

**I nostri uffici sono aperti dal Lunedì al Venerdì
dalle 8.00 alle 12.00 e dalle 13.30 alle 17.30**

Tel +39 030 829910 - Fax +39 030 8920970

Servizio internet: www.metalglas.it - Servizio e-mail: info@metalglas.it

Invio ordini: ordini@metalglas.it

- ▶ Le presenti condizioni generali di vendita si intendono integralmente accettate dal cliente con il conferimento dell'ordine. Gli ordini o gli impegni assunti dai nostri rappresentanti sono validi unicamente dopo nostra accettazione o conferma scritta.
- ▶ I dati, le misure, gli articoli, i prezzi, le caratteristiche, le prestazioni e tutti gli altri dati riprodotti nei nostri cataloghi, listini, prospetti, circolari etc. hanno carattere indicativo; essi possono essere variati senza alcun preavviso, e hanno valore vincolante per noi unicamente in caso di espressa indicazione nell'accettazione o nella conferma.
- ▶ Tutti i nostri prodotti vengono accuratamente collaudati in stabilimento. Difetti non chiaramente attribuibili alla fabbricazione verranno esaminati presso il nostro servizio di controllo qualità ed eventualmente addebitati a seconda dell'esito della verifica.
- ▶ Sono comunque esclusi dalla garanzia i danni accidentali per il trasporto, per incuria, per uso ed installazione errati o non conformi alle avvertenze riportate sul libretto di istruzioni



RESI MERCE

I prodotti devono essere rispediti perfettamente integri, nell'imballo originario, in porto franco e con il relativo documento di trasporto. Ogni reso merce dovrà essere concordato con i nostri uffici e le restituzioni dovranno avvenire tassativamente entro 8 giorni dalla data di ricevimento della merce. Senza le condizioni sopra descritte non sarà possibile effettuare alcun rimborso.

La Metalglas si riserva il diritto di controllo. Materiale che presenta difetti non dichiarati prima della spedizione di rientro verrà rispedito al mittente senza alcun accredito. Per i resi non imputabili a errori Metalglas verrà decurtato dall'accredito il 20% del valore per il recupero dei costi di controllo e ripristino imballi.



MODALITÀ DI PAGAMENTO

Il pagamento dovrà essere effettuato alle scadenze concordate e indicate nella conferma d'ordine e nella relativa fattura successiva. La Metalglas ha facoltà di chiedere il versamento di un acconto sul prezzo dell'ordine. Qualora l'ordine fosse annullato o la merce non venga ritirata o ritirata solo in parte, la somma versata quale acconto, verrà trattenuta dalla Metalglas quale penale ex art.1382 c.c..

Il pagamento per le prime forniture sarà da effettuarsi in anticipo con bonifico bancario. Le modalità di pagamento per le successive forniture saranno da concordarsi con l'ufficio commerciale. Per i pagamenti tramite Ri.Ba verranno addebitate al cliente le spese da noi sostenute. In caso di ritardo nel pagamento la Metalglas potrà sospendere tutti gli ordini da evadere sino al momento del pagamento. In caso di insolvenze la Metalglas si riserva inoltre il diritto di cambiare le condizioni di pagamento del cliente insolvente.



CONSEGNA

La merce va controllata interamente alla ricezione. Per eventuali costi indiretti non ci assumiamo alcuna responsabilità. La consegna avviene, in assenza di precise indicazioni da parte dell'acquirente, secondo la modalità franco con addebito in fattura e attraverso un vettore scelto dalla ditta venditrice.

Le spese di trasporto, assicurazione ed ogni altro onere relativo all'inoltro della merce è a carico dell'acquirente. Il rischio relativo alla merce passa in capo al cliente al momento della consegna della stessa al vettore. I termini di consegna hanno valore indicativo, riflettendo condizioni normali di produzione suscettibili di variazione in fase di produzione della merce. Nel caso in cui sia richiesto il pagamento di un acconto, i termini di consegna decorrono dal momento della ricezione di tale importo da parte del venditore.

Decliniamo ogni responsabilità per eventuali danni a persone, animali o cose derivanti dall'utilizzo dei nostri prodotti senza osservanza delle prescrizioni di sicurezza o comunque non installati correttamente e/o installati senza effettuare i controlli d'uso. I prezzi riportati sul listino si intendono al netto dell'IVA.

Eventuali ritardi nelle consegne non daranno diritto al cliente ad indennizzi e/o risarcimento danni.

Le consegne, anche se parziali di merce, non possono essere rifiutate dal cliente e non danno diritto all'annullamento dell'ordine. Per ritardi di consegna e costi indiretti dovuti ad errori ed a eventuali difetti non ci assumiamo alcuna responsabilità.



TRASPORTO CONDIZIONI E COSTI EXTRA PER PROFILI CON LUNGHEZZA SUPERIORE A 5,2 MT.

TRASPORTO PROFILI PER SCORREVOLI E PARETI MOBILI

ATTENZIONE: il trasporto di binari con lunghezza superiore ai 5,2 metri verrà effettuato con un corriere speciale. I tempi di consegna si aggirano intorno ai 7 giorni lavorativi a seconda della zona. Le tariffe standard vengono quadruplicate dai 5,2 metri. È possibile il taglio a misura dei profili fino a 5,2 m in modo da utilizzare i corrieri tradizionali. Il costo per il taglio è esposto nella versione MIS= 3000 → 6000 mm e TAGLIO-PM per le pareti mobili.

TRASPORTO PROFILI PER LOGGIA GLASS

ATTENZIONE: il trasporto di binari con lunghezza superiore ai 5,2 metri verrà effettuato con un corriere speciale. I tempi di consegna si aggirano intorno ai 7 giorni lavorativi a seconda della zona. Le tariffe standard vengono quadruplicate dai 5,2 metri. È possibile il taglio a misura dei profili fino a 5,2 m in modo da utilizzare i corrieri tradizionali. Il costo per n° 3 tagli dei 3 profili componenti il set LOGGIA GLASS è di € 60,00 a set da ordinare separatamente con l'articolo TAGLIO-LG-SET.

TRASPORTO PER PROFILI A SCATTO

ATTENZIONE: Questi profili sono a magazzino già imballati nella misura di 3 e 6 metri. Il trasporto di profili con lunghezza superiore ai 5,2 metri verrà effettuato con un corriere speciale. I tempi di consegna si aggirano intorno ai 7 giorni lavorativi a seconda della zona. Le tariffe standard vengono quadruplicate dai 5,2 metri. È possibile il taglio a misura dei profili **già imballati** fino a 5,2 metri in modo da utilizzare un corriere tradizionale. Vi informiamo che la misura dei profili a scatto dopo il **taglio non potrà mai essere precisa** essendo i profili tagliati nel loro imballo originale. Il costo per il taglio dei profili a scatto è il seguente:

- Articolo TAGLIO-SCAT-UNI costo per un taglio con misure uguali per tutti i profili € 23 per ogni profilo.
- Articolo TAGLIO-SCAT-SM costo per un taglio con misure diverse per ogni profilo € 27 per ogni misura.

TRASPORTO PROFILI CON IMBALLO INDUSTRIALE

ATTENZIONE: il trasporto di binari con lunghezza superiore ai 5,2 metri verrà effettuato con un corriere speciale. I tempi di consegna si aggirano intorno ai 7 giorni lavorativi a seconda della zona. Le tariffe standard vengono quadruplicate dai 5,2 metri. La tariffa del trasporto va calcolata di volta in volta in base alla quantità e al volume della merce ordinata.

FORO COMPETENTE

Per le controversie relative a validità, interpretazione, esecuzione e risoluzione del presente accordo è competente esclusivamente il Foro di Brescia.

SI PREGA DI NOTARE

La Metalglas si riserva il diritto di apportare variazioni tecniche di fabbricazione, di dimensione e di prezzo ai prodotti. I prodotti originali possono differire leggermente dalle rappresentazioni fotografiche. A questo proposito non sarà accettato alcun reclamo. Metalglas declina ogni responsabilità giuridica non legalmente prevista per eventuali errori di stampa. È previsto un minimo d'ordine di € 50,00. Per ordini inferiore a 100,00 € saranno addebitati € 20,00 come di contributo per le spese di gestione oltre alle spese di trasporto.

Il presente listino annulla e sostituisce tutti i precedenti.

GENERAL SALES CONDITIONS



**Our offices are open from Monday to Friday
from 8.00 to 12.00 and from 13.30 to 18.00**

Tel +39 030 829910 - Fax +39 030 8920970

Internet Services: www.metalglas.it - E-mail service: info@metalglas.it

Order email: ordini@metalglas.it

- ▶ These general terms and conditions of sale are considered to be wholly accepted by the customer when an order is placed. Orders or commitments taken on by our representatives are only valid after our acceptance or written confirmation.
- ▶ The data, measurements, items, prices, features, services and all other data reproduced in our catalogues, price lists, prospectuses, circulars, etc. are purely indicative; they may be modified without prior notice and are binding on us only if expressly indicated in the order acceptance or in the order confirmation.
- ▶ All our products are carefully tested in our facility. Any defects not clearly attributable to manufacturing will be examined by our quality control service and any costs charged will be based on the results of this examination.
- ▶ Excluded from the warranty are accidental transportation damage due to negligence, improper use or installation or any use or installation that does not conform to the warnings and notices given in the instruction booklet.



RETURNED GOODS

The products must be returned undamaged in the original packaging, freight prepaid, and with its transport document. Returned merchandise must be arranged with our offices and returns must be made strictly no later than 8 days on receipt of the goods. Without the above conditions no refund can be made. Metalglas Bonomi reserves the right to control goods. Goods with defects not declared before the return shipment will be returned to the sender with no credit. For returns not attributable to

Metalglas Bonomi error 20% of the value of the credit will be deducted for the recovery of costs of controls and recovering the packages.



METHODS OF PAYMENT

Payment should be made at agreed deadlines shown in the order confirmation and subsequently in the relevant invoice. Metalglas Bonomi has the right to request payment of a deposit of the order price. If the order is cancelled or the goods are not collected or collected in part, the amount paid as a deposit, will be retained by Metalglas Bonomi in accordance with criminal ex art.1382 cc. Payment for first supply orders will be made in advance by bank transfer. The methods of payment for subsequent deliveries will be agreed on with the sales department.

For payments by bank draft the customer will be charged for costs incurred by Metalglas Bonomi. In case of delay in payment Metalglas Bonomi may suspend all outstanding orders until the time of payment. In the event of insolvency Metalglas Bonomi also reserves the right to change the method of payment of the insolvent customer.

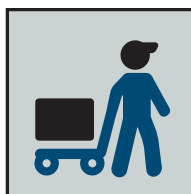

DELIVERY

Goods must be thoroughly checked upon receipt. We will not accept any liability for any indirect costs.

In the absence of specific instructions by the buyer, delivery will take place ex port with charges in the invoice and through a courier chosen by Metalglas Bonomi. The costs of transport, insurance and all other related costs to the forwarding of the goods shall be borne by the buyer. The risk relative to the goods is transferred to the customer when goods are handed over to the courier. The terms of delivery are indicative, reflecting normal conditions of production subject to changes in the production phase of the goods. In the event that a down payment is required, terms of delivery shall commence upon receipt of this amount by the seller.

In the event in which a down payment is requested, the delivery terms start from the moment this amount is received by the seller.

We decline any liability for any damage to people, animals or property deriving from the use of our products without observing the safety precautions or, in any case, deriving from products not installed correctly and/or installed without carrying out the use checks.

The prices given on the price list are net of VAT.

In the event of a delay in the delivery, the customer is not entitled to reimbursements nor compensation for damages.

Delivery, even if partial, cannot be refused by the customer and does not entitle the customer to cancel the order.

We will not accept any liability for any delay in the delivery nor for any indirect costs due to errors and any defects.



TRANSPORTATION: THERE ARE EXTRA CONDITIONS AND COSTS FOR PROFILES LONGER THAN 5.2M.

TRANSPORTATION OF SLIDING SYSTEM AND SLIDING WALLS

WARNING: tracks longer than 5.2 metres will be transported by means of a special courier.

Delivery times are around 7 working days depending on the area. Standard rates are quadrupled after 5.2 metres. It is possible to cut the profiles to 5.2 metres in order to use traditional couriers. The cost for the cut is shown in the version MIS = 3000 → 6000 mm and TAGLIO-PM for sliding walls.

TRANSPORTATION OF LOGGIA GLASS

WARNING: Tracks longer than 5.2 metres will be transported by means of a special courier. Delivery times are around 7 working days depending on the area. Standard rates are quadrupled after 5.2 metres. It is possible to cut the profiles to 5.2 metres in order to use traditional couriers. The cost for 3 cuts of the 3 profiles composing the LOGGIA GLASS set is € 60.00 per set to be ordered separately with the article TAGLIO-LG-SET.

TRANSPORTATION OF CLIP PROFILES

WARNING: These profiles are already packed in the warehouse in the measure of 3 and 6 meters. Tracks longer than 5.2 metres will be transported by means of a special courier. Delivery times are around 7 working days depending on the area. Standard rates are quadrupled after 5.2 metres. It is possible to cut the profiles to 5.2 metres in order to use traditional couriers. It is possible to cut **already packaged** profiles to 5.2 metres in order to use a traditional courier. Please note that the size of the clip profiles after **cutting will not be precise** as the profiles are cut in their original packaging. The cost to cut clip profiles is the following:

- TAGLIO-SCAT-UNI article: cost per cut with same size for all profiles € 23 for each profile.
- TAGLIO-SCAT-SM article: cost per cut with different sizes for each profile € 27 for each size.

TRANSPORTATION OF PROFILES INDUSTRIAL PACKAGE

WARNING: Tracks longer than 5.2 metres will be transported by means of a special courier. Delivery times are around 7 working days depending on the area. Standard rates are quadrupled after 5.2 metres. The cost of transport is calculated each time based on the quantity and volume of the goods ordered.

JURISDICTION

Disputes relating to the validity, interpretation, performance and termination of this Agreement shall be dealt with exclusively by the Court of Brescia.

PLEASE NOTE

1. Metalglas Bonomi reserves the right to make changes in manufacturing techniques, size and price the products.
2. The original product may differ slightly from photographic representations. In this respect we will not accept any complaints.
3. Metalglas Bonomi disclaims any legal responsibility that is not legally foreseen for misprints.

ALLGEMEINE GESCHÄFTSBEDINGUNGEN

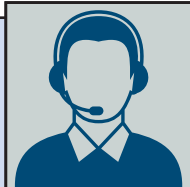

**Unsere Büros sind von Montag - Freitag
von 8.00 bis 12.00 und von 13.30 bis 18.00 geöffnet**
Telefon +39 030 829910 - Fax +39 030 8920970
Website: www.metalglas.it - Email-Adresse: info@metalglas.it
Bestellung Email-Adresse: ordini@metalglas.it

- ▶ Diese Allgemeinen Verkaufsbedingungen gelten mit der Auftragserteilung als vom Kunden vollständig akzeptiert. Bestellungen oder Zusagen unserer Vertreter sind erst nach unserer Annahme oder schriftlichen Bestätigung gültig.
- ▶ Die in unseren Katalogen, Preislisten, Prospekten, Rundschreiben usw. wiedergegebenen Daten, Maße, Artikel, Preise, Eigenschaften, Leistungen und alle anderen Daten sind indikativ; sie können ohne vorherige Ankündigung geändert werden und sind für uns nur bei ausdrücklicher Angabe in der Annahme oder Bestätigung verbindlich.
- ▶ Alle unsere Produkte werden im Werk gründlich getestet. Mängel, die nicht eindeutig der Herstellung zuzuordnen sind, werden von unserem Qualitätskontrolldienst untersucht und je nach Ergebnis der Prüfung in Rechnung gestellt.
- ▶ Die Garantie erstreckt sich nicht auf Transportschäden, Schäden aufgrund von Fahrlässigkeit, unsachgemäßer Verwendung und Installation oder infolge von Nichtbeachtung der Warnhinweise in der Bedienungsanleitung.



WARENRÜCKGABE

Die Waren müssen im perfekten Ausgangszustand in der Originalverpackung frachtfrei und mit den entsprechenden Transportdokumenten zurückgesendet werden. Jede Warenrückgabe muss mit unseren Büros abgesprochen werden und die Rücksendung muss innerhalb von 8 Tagen nach Warenerhalt erfolgen. Bei Nichteinhaltung dieser Bedingungen ist keine Rückvergütung möglich. Metalglas Bonomi behält sich das Recht auf Kontrolle vor. Material mit nicht deklarierten Defekten wird ohne Rückvergütung an den Absender zurückgeschickt. Für Warenrückgaben, die nicht auf Fehler von Seiten der Firma Metalglas Bonomi zurückzuführen sind, werden von der Gutschrift 20% des Wertes für Unkosten wie Kontrolle und Verpackung abgezogen.



ZAHLUNGSWEISE

Die Zahlung muss innerhalb den vereinbarten und in der Auftragsbestätigung sowie in der nachfolgenden Rechnung angegebenen Fristen geleistet werden. Die Firma Metalglas Bonomi ist berechtigt, die Überweisung einer Vorauszahlung auf den Auftragswert zu verlangen. Falls die Bestellung annulliert oder die Ware nicht abgeholt oder nur zum Teil abgeholt wird, behält die Firma Metalglas Bonomi den als Vorauszahlung geleisteten Betrag als Strafe laut Art. 1382 BGB ein. Die ersten Lieferungen sind im Voraus per Banküberweisung zu zahlen. Die Zahlungsweise für weitere Lieferungen muss mit dem Verkaufsbüro abgesprochen werden. Für Zahlungen mittels Ri.Ba werden dem Kunden die der Firma Metalglas Bonomi anwachsenden Spesen verrechnet. Bei Zahlungsverzug kann Metalglas Bonomi bis zur Zahlung alle auszuführenden Bestellungen unterbrechen. Im Fall von Insolvenzen behält sich Metalglas Bonomi das Recht vor, die Zahlungsbedingungen für den insolventen Kunden zu ändern.

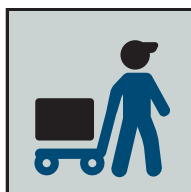

LIEFERUNG

Die Ware ist nach Erhalt vollständig zu prüfen. Wir übernehmen keine Haftung für indirekte Kosten. Die Lieferung erfolgt frei ab Werk. Bei Fehlen von genauen Angaben des Käufers wird die Ware dem Empfänger mit einem von der Firma Metalglas Bonomi gewählten Frachtführer geschickt. Die Transport- und Versicherungskosten sowie alle weiteren Aufwendungen in Bezug auf die Warensendung gehen zu Lasten des Käufers. Das Risiko für die Ware geht im Moment der Warenübergabe an den Frachtführer auf den Kunden über. Die Lieferfristen sind richtungsweisend und basieren auf den normalen Produktionsbedingungen, die in der Produktionsphase der Ware Änderungen unterliegen können. Die vereinbarten Fristen laufen auf alle Fälle ab dem Datum der übermittelten Auftragsbestätigung. Falls die Überweisung einer Vorauszahlung vorgesehen ist, laufen die Lieferfristen ab dem Moment, ab dem der Verkäufer den betreffenden Betrag erhalten hat. Ist eine Anzahlung erforderlich, beginnt die Lieferfrist mit dem Eingang der Anzahlung beim Verkäufer. Wir haften nicht für Personen-, Tier- oder Sachschäden, die sich aus der Verwendung unserer Produkte ohne Beachtung

der Sicherheitshinweise oder in jedem Fall durch nicht ordnungsgemäße Installation und/oder Installation ohne Durchführung von Gebrauchskontrollen ergeben.

Die in der Preisliste angegebenen Preise verstehen sich zuzüglich der gesetzlichen Mehrwertsteuer.

Lieferverzögerungen berechtigen den Kunden nicht zu Entschädigungen und/oder Schadenersatz.

Eine Lieferung, auch wenn sie nur teilweise erfolgt, kann vom Kunden nicht abgelehnt werden und berechtigt nicht zum Widerruf der Bestellung.

Für Lieferverzögerungen oder indirekte Kosten aufgrund von Fehlern oder Mängeln übernehmen wir keine Haftung.



TRANSPORT: BEDINGUNGEN UND MEHRKOSTEN FÜR PROFILE ÜBER 5,2 M.

TRANSPORT SCHIEBETÜRSYSTEME UND SCHIEBEWÄNDE SYSTEME.

ACHTUNG: Schienen von einer Länge über 5,2 Metern werden mit einem Sonderspeditionsdienst versendet. Die Lieferfristen liegen um 7 Werktagen je nach dem Zielort. Die Standardtarife werden ab 5,2 Meter vervierfacht. Wie können die Profile bis zu 5,2 m nach Maß schneiden, sodass sie mit einem traditionellen Speditionsdienst versendet werden können. Der Preis für den Schnitt wird in der Version MIS = 3000 → 6000 mm und TAGLIO-PM für Schiebewände Systeme gezeigt

TRANSPORT LOGGIA

ACHTUNG: Schienen von einer Länge über 5,2 Metern werden mit einem Sonderspeditionsdienst versendet. Die Lieferfristen liegen um 7 Werktagen je nach dem Zielort. Die Standardtarife werden ab 5,2 Meter vervierfacht. Wie können die Profile bis zu 5,2 m nach Maß schneiden, sodass sie mit einem traditionellen Speditionsdienst versendet werden können. Der Preis für 3 Schnitte der Profile, die zum Set LOGGIA GLASS gehören, beträgt € 60,00 pro Set und muss getrennt mit dem Artikel TAGLIO-LG-SET bestellt werden.

TRANSPORT KLIPS-PROFILE

ACHTUNG: Klips-profile sind auf Lager in Längen 3 und 6 Meter bereits verpackt. Schienen von einer Länge über 5,2 Metern werden mit einem Sonderspeditionsdienst versendet. Die Lieferfristen liegen um 7 Werktagen je nach dem Zielort. Die Standardtarife werden ab 5,2 Meter vervierfacht. Wie können die Profile bis zu 5,2 m nach Maß schneiden, sodass sie mit einem traditionellen Speditionsdienst versendet werden können. Wir können **bereits verpackte** Profile nach Maß bis zu 5,2 m schneiden, sodass sie mit einem traditionellen Speditionsdienst versendet werden können. Das Maß der Klick-Profile **kann nach dem Schnitt nicht präzise sein**, da die Profile in ihren Verpackungen geschnitten worden sind. Der Preis für den Schnitt der Klick-Profile ist:

- Artikel TAGLIO-SCAT-UNI Preis für einen Schnitt mit für alle Profile gleichem Maß € 23 für jedes Profil.
- Artikel TAGLIO-SCAT-SM Preis für einen Schnitt mit verschiedenen Maßen für jedes Profil € 27 für jedes Maß.

TRANSPORT PROFILE INDUSTRIERVERPACK

ACHTUNG: Schienen von einer Länge über 5,2 Metern werden mit einem Sonderspeditionsdienst versendet. Die Lieferfristen liegen um 7 Werktagen je nach dem Zielort. Die Standardtarife werden ab 5,2 Meter vervierfacht. Der Tarif für den Versand wird auf Basis der Menge und des Umfangs der bestellten Ware berechnet.

GERICHTSSTAND

Für Streitigkeiten in Bezug auf Gültigkeit, Auslegung, Ausführung und Aufhebung des vorliegenden Vertrages ist ausschließlich das Gericht Brescia zuständig.

ZU BEACHTEN

- 1- Die Firma Metalglas Bonomi behält sich das Recht vor, zu jeder Zeit und ohne Vorankündigung Preise, sowie technische, funktionelle oder die Abmessungen betreffende Merkmale der Produkte zu ändern.
- 2- Die Originalprodukte können leicht von den Fotografien abweichen, wobei diesbezüglich keine Reklamationen möglich sind.
- 3- Die Firma Metalglas Bonomi weist für eventuelle Druckfehler jegliche nicht gesetzlich vorgesehene Verantwortlichkeit zurück.
- 4- Die vorgesehene Mindestbestellung beträgt € 50,00 zuzüglich MwSt. Für Bestellungen unter 100,00 € werden außer den Transportkosten 20,00 € als Unkostenbeitrag verrechnet.

Die vorliegende Preisliste annulliert und ersetzt alle früheren Preislisten.

SIMBOLI | SYMBOLS | SYMBOLE



PORTATA
LOAD CAPACITY
TRAGKRAFT

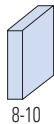

SPESSORE VETRO
GLASS THICKNESS
GLASDICKE

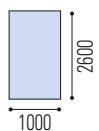

MISURE ANTA
PANEL MEASURES
TÜRGRÖSSE



SISTEMA SOFT-CLOSE
SOFT-CLOSE SYSTEM
SOFT-CLOSE SYSTEM



MOVIMENTO SINCRONIZZATO
SYNCHRONIZED MOVEMENT
SYNCHRONISIERTE BEWEGUNG



TRASCINAMENTO CON CINGHIA
DRAGGING SYSTEM WITH TOOTHED BELT
MITNEHMER KIT MIT ZAHNRIEMEN



TRASCINAMENTO CON FUNE
DRAGGING SYSTEM WITH CABLE
MITNEHMER KIT MIT SEILZUG

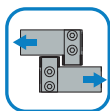

TRASCINAMENTO MECCANICO
MECHANICAL DRAGGING SYSTEM
MIT MECHANISCHEM MITNEHMER

FIXED

ANTA FISSA
FIXED PANEL
SEITENTEIL



ANTA SCORREVOLE
SLIDING DOOR
SCHIEBETÜR

MY METALGLAS

IL CALCOLATORE DEI VETRI
THE GLASS CALCULATOR
KONFIGURATOR FÜR DIE GLASBERECHNUNG

FINITURE | FINISHES | OBERFLÄCHEN

CP

Cromo perla
Chrome perla similar Alu
Chrom perla ähnlich Alu

CS

Cromo satinato
Satin chrome
Chrom matt

NS

Nickel satinato
Satin nickel
Ähnlich Edelstahl matt

CR

Cromo lucido
Polished chrome
Chrom glänzend

OL

Ottone lucido
Polished brass
Messing poliert

GR

Grezzo
Raw
Roh

LEGENDA

LP

Passaggio luce
Clear opening width
Lichte Durchgangsbreite

H | HP

Altezza passaggio luce
Clear opening height
Lichte Durchgangshöhe

LM | LA

Larghezza anta mobile
Sliding door width
Schiebeflügel Breite

HM | HA

Altezza anta mobile
Sliding glass height
Schiebeflügel Höhe

HF

Altezza anta fissa
Side fixed glass height
Seitenteil Höhe

LF

Larghezza anta fissa
Fixed glass width
Seitenteil Breite

AN

Alluminio anodizzato
Aluminium anodized
Aluminium Silberfarbig

IX

Acciaio inox satinato
Satin stainless steel
Edelstahl matt

IXE

Effetto inox satinato
Inox effect
Inox effekt

IL

Acciaio inox lucido
Polished stainless steel
Edelstahl poliert

NO

Nero opaco
Matt black
Schwarz matt

AG

Verniciato argento
Painted silver
Silber lackiert

LB

Lunghezza binario
Rail length
Laufschiene Länge

HB

Altezza fissaggio binario
Rail installation height
Laufschiene montage Höhe

LV

Larghezza vetro
Glass width
Glas Breite

HV

Altezza vetro
Glass height
Glas Höhe

HS

Altezza stipite
Frame height
Zarge Höhe

LS

Larghezza stipite
Frame width
Zarge Breite

GUIDA TECNICA PER LA SCELTA DEL VOSTRO SISTEMA
TECHNICAL GUIDE FOR THE CHOICE OF YOUR SYSTEM
AUSWAHL VON SCHIEBETÜRSYSTEME NACH VORHANDENEN KRITERIEN

1 O 2 ANTE
1 OR 2 SLIDING DOORS
1 ODER 2-FLÜGELIG

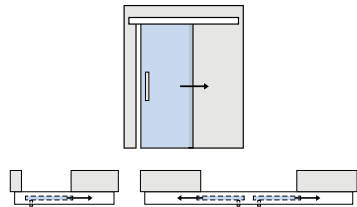

1 O 2 ANTE CON PANNELLO FISSO
1 OR 2 WAYS WITH FIXED PANEL
1 ODER 2-FLÜGELIG MIT SEITENTEIL

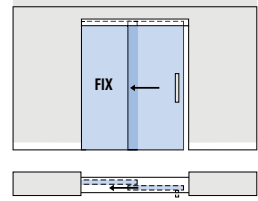

V-5500 | V-5510
Fifty SOFT-CLOSE

▶ 14

EVOLUTION MINI SOFT-CLOSE

V-5420 120 Kg 70 Kg ▶ 18

V-5400 120 Kg 80 Kg ▶ 18

V-5410 120 Kg 120 Kg ▶ 19

EVOLUTION MINI SOFT-CLOSE

V-5430 70 Kg 70 Kg ▶ 20

V-5450 70 Kg 80 Kg ▶ 20

V-5100 | V-5150
EVOLUTION

▶ 26-26

V-5140
EVOLUTION MINI

▶ 30

V-5000
COMPACT ▶ 34

V-2000
SESAMO ▶ 48

V-5045 | V-5050
COMPACT H 45

▶ 30

V-5040 | V-5035
COMPACT H 40

▶ 32

V-1860
BRIXIA HEAVY (OPTIONAL SOFT-CLOSE)

▶ 37

PO-290
BRIXIA (OPTIONAL SOFT-CLOSE)

▶ 37

V-1840
BRIXIA 50 SOFT-CLOSE

▶ 43

V-1890
BRIXIA 140 (OPTIONAL SOFT-CLOSE)

▶ 45

V-1800 | V-1810
V-1850 | V-1855
BRIXIA (OPTIONAL SOFT-CLOSE)

▶ 64-65
▶ 65-66

V-5503 | V-5513
Fifty SOFT-CLOSE

▶ 14-15

EVOLUTION MINI SOFT-CLOSE

V-5423 120 Kg 70 Kg ▶ 18

V-5403 120 Kg 80 Kg ▶ 19

V-5413 120 Kg 120 Kg ▶ 19

EVOLUTION MINI SOFT-CLOSE

V-5433 70 Kg 70 Kg ▶ 20

V-5453 70 Kg 80 Kg ▶ 21

V-5103 | V-5153
EVOLUTION

▶ 26-27

V-1863
BRIXIA HEAVY (OPTIONAL SOFT-CLOSE)

▶ 37

V-1893
BRIXIA 140 (OPTIONAL SOFT-CLOSE)

▶ 46

V-1803
BRIXIA (OPTIONAL SOFT-CLOSE)

▶ 65

1 O 2 ANTE CON BINARIO INVISIBILE
1 OR 2 SLIDING DOORS WITH INVISIBLE RAIL
1 ODER 2-FLÜGELIGE
MIT UNSICHTBARER LAUFSCHIENE

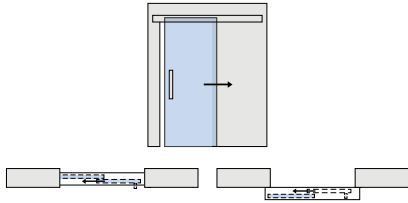

V-7100
INVISIBILE
(OPTIONAL
SOFT-CLOSE)

▶ 50

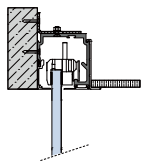

V-7103
INVISIBILE
(OPTIONAL
SOFT-CLOSE)

▶ 50

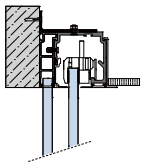

V-7150 | V-7160
INVISIBILE
EVOLUTION
(OPTIONAL
SOFT-CLOSE)

▶ 52-52

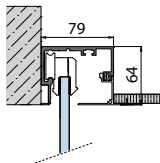

V-7153 | V-7163
INVISIBILE
EVOLUTION
(OPTIONAL
SOFT-CLOSE)

▶ 52-53

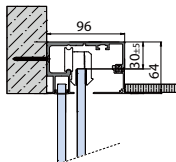

V-1815
BRIXIA INVISIBILE

▶ 55

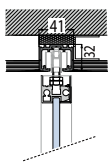

V-1815-F
BRIXIA INVISIBILE
(OPTIONAL
SOFT-CLOSE)

▶ 56

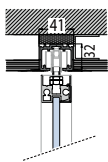

V-1660
SEMI-VISIBILE
SOFT-CLOSE

▶ 59

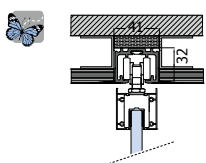

PO-290-INV
EASY FRAME
SEMI-VISIBILE
(OPTIONAL
SOFT-CLOSE)

▶ 62

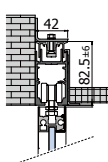

1 O 2 ANTE CON SISTEMI TECNICI
1 OR 2 SLIDING DOORS
WITH VISIBLE MECHANISM
1 ODER 2-FLÜGELIG MIT SICHTBARER
TECHNIK

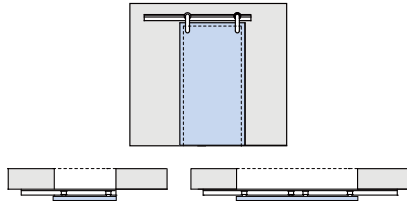

V-8200 | V-8250
MOOVI
SOFT-CLOSE

▶ 72-72

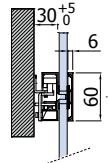

V-8000 | V-8100
V-8050 | V-8040
INDEPENDENT

▶ 73-74
▶ 74-74

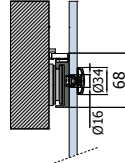

V-6550 | V-6520
MINIMAL
QUADRO RUOTA
SOFT-CLOSE

▶ 76-77

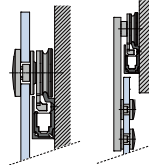

V-6750 | V-6720
MINIMAL
TONDO CON ASTA
SOFT-CLOSE

▶ 79-80

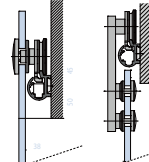

R-1000
ROLLING CENTER

▶ 82

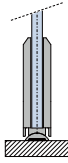

VL-6100
ROLLIE

▶ 84

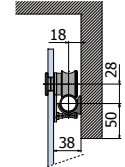

VL-3000
SLIDING TECH

▶ 85

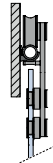

ANTE A SCOMPARSA
PER CONTROTELAIO STANDARD
FLUSH SLIDING DOORS
FOR STANDARD POCKET SYSTEMS
SCHIEBETÜREN IN DER WAND LAUFEND
MIT STANDARD KASTENRAHMENSYSTEME

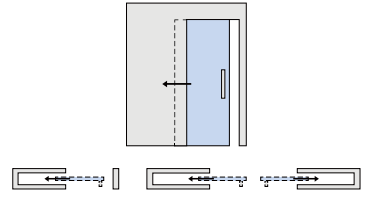

V-7100
INVISIBILE
(OPTIONAL
SOFT-CLOSE)

▶ 50

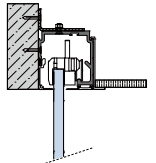

TS-04 TELAIO
V-011-FU | PO-290

▶ 328

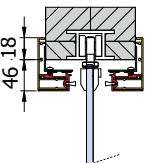

V-1664
SEMI-VISIBILE

▶ 61

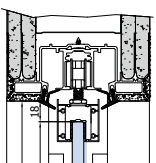

V-1664
TS-03 PROFILI LEGNO,
V-1664 KIT PINZE

▶ 61

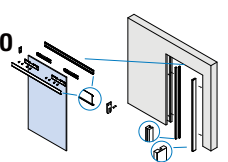

GUIDA TECNICA PER LA SCELTA DEL VOSTRO SISTEMA
TECHNICAL GUIDE FOR THE CHOICE OF YOUR SYSTEM
AUSWAHL VON SCHIEBETÜRSYSTEME NACH VORHANDENEN KRITERIEN

TELESCOPICO 2 ANTE + OPTIONAL FISSO
2-WAYS TELESCOPIC SYSTEMS
WITH OPTIONAL FIXED PANEL
2 LÄUFIGES TELESKOP-SCHIEBETÜRSYSTEM
MIT OPTION AUF FESTVERGLASUNG

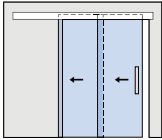

V-1820 | V-1870
BRIXIA SINCR0 2 VIE
(OPTIONAL
SOFT-CLOSE)

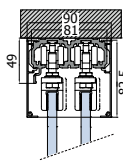

► 88 - 89

V-1825 | V-1875
BRIXIA SINCR0
2 VIE + FISSO
(OPTIONAL
SOFT-CLOSE)

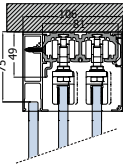

► 89 - 90

V-7200
INVISIBILE DOPPIO
TELESCOPICO

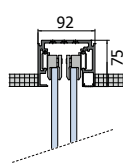

► 98

V-7300
INVISIBILE
TELESCOPICO
SINCR0

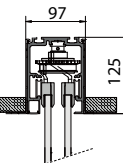

► 100

PO-220
EASY FRAME
TELESCOPICO
SINCR0 (OPTIONAL
SOFT-CLOSE)

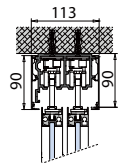

► 102

PO-230
EASY FRAME
TELESCOPICO
(OPTIONAL
SOFT-CLOSE)

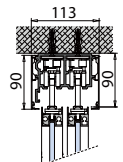

► 103

V-2200
TELESCOPICO
SINCR0 2 VIE
(OPTIONAL
SOFT-CLOSE)

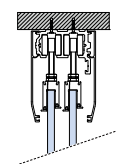

► 107

V-2250
TELESCOPICO
SINCR0 2 VIE + FISSO
(OPTIONAL
SOFT-CLOSE)

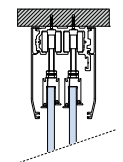

► 107

TELESCOPICO 3 ANTE + OPTIONAL FISSO
3-WAYS TELESCOPIC SYSTEMS
WITH OPTIONAL FIXED PANEL
3 LÄUFIGES TELESKOP-SCHIEBETÜRSYSTEM
MIT OPTION AUF FESTVERGLASUNG

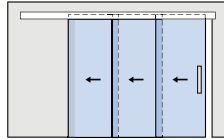

V-1830 | V-1880
BRIXIA SINCR0 3 VIE
(OPTIONAL
SOFT-CLOSE)

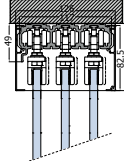

► 90 - 91

V-1835 | V-1885
BRIXIA SINCR0
3 VIE + FISSO
(OPTIONAL
SOFT-CLOSE)

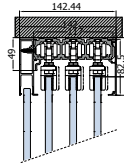

► 91 - 92

V-2300
TELESCOPICO
SINCR0 3 VIE
(OPTIONAL
SOFT-CLOSE)

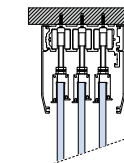

► 110

V-2350
TELESCOPICO
SINCR0 3 VIE + FISSO
(OPTIONAL
SOFT-CLOSE)

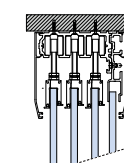

► 110

TELESCOPICO 4 ANTE + OPTIONAL FISSO
4-WAYS TELESCOPIC SYSTEMS
WITH OPTIONAL FIXED PANEL
4 LÄUFIGES TELESKOP-SCHIEBETÜRSYSTEM
MIT OPTION AUF FESTVERGLASUNG

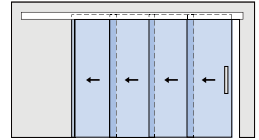

V-2400
TELESCOPICO
SINCR0 4 VIE
(OPTIONAL
SOFT-CLOSE)

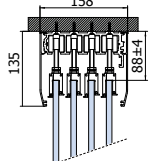

► 113

V-2450
TELESCOPICO
SINCR0 4 VIE + FISSO
(OPTIONAL
SOFT-CLOSE)

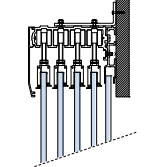

► 113

INVISIBILI TELESCOPICI
TELESCOPIC SYSTEMS WITH INVISIBLE RAIL
TELESKOP-SCHIEBETÜRSYSTEM MIT UNSICHTBARER LAUFSCHIENE

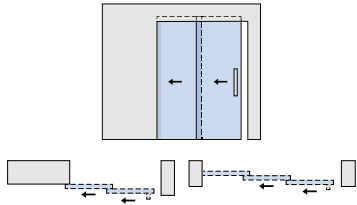

V-1815
BRIXIA INVISIBILE

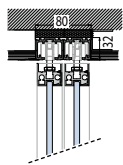

▶ 55

V-1815-F
BRIXIA INVISIBILE
(OPTIONAL
SOFT-CLOSE)

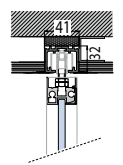

▶ 56

V-7200
INVISIBILE DOPPIO
TELESCOPICO

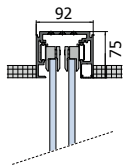

▶ 98

V-7300
INVISIBILE
TELESCOPICO
SINCRO

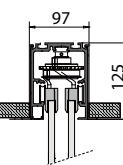

▶ 100

SOFFIETTINO
FOLDING SYSTEM
RAUMSPARTÜR

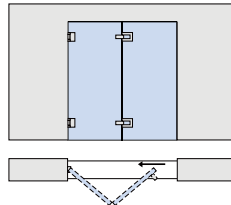

L-2600
SOFFIETTINO

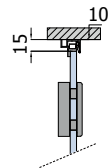

▶ 115

L-2650
SOFFIETTINO

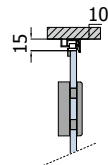

▶ 116

ACCESSORI SISTEMI SCORREVOLI
ACCESSORIES FOR SLIDING SYSTEMS
ZUBEHÖR FÜR SCHIEBETÜRSYSTEME



PINZE
CLAMPS
KLEMMSCHUHE



▶ 117

NICCHIE PER SCORREVOLI
SLIDING HANDLES
GRIFFMUSCHELN



▶ 121

GUIDE A PAVIMENTO
FLOOR GUIDES
BODENFÜHRUNGEN



▶ 124

ACCESSORI
ACCESSORIES
ZUBEHÖRE

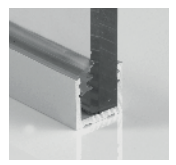

▶ 125

POS.	PROD.	ART.	MIS.	Q.TÀ	FIN.	EURO	FIN.	EURO	FIN.	EURO
Fifty SOFT-CLOSE										
V-5500 70 Kg 70 Kg ▲ SLIDING 14/15										
A. 01		V-5500 SET 1 FIX	2000 mm	1 set	AN	414,30/set	IXE	478,30/set		
			3000 mm	1 set	AN	484,50/set	IXE	576,70/set		
			4000 mm	1 set	AN	553,50/set	IXE	675,00/set		
			1500 → 3000 mm	1 set	AN	543,00/set	IXE	646,30/set		
		V-5500 SET 1 MIS	3000 → 6000 mm	1 set	AN	782,70/set	IXE	985,00/set		
A. 02		V-5500 SET 2 FIX	3000 mm	1 set	AN	720,30/set	IXE	817,00/set		
			4000 mm	1 set	AN	789,70/set	IXE	915,30/set		
			6000 mm	1 set	AN	935,70/set	IXE	1119,30/set		
			1500 → 3000 mm	1 set	AN	778,00/set	IXE	882,00/set		
		V-5500 SET 2 MIS	3000 → 6000 mm	1 set	AN	1010,30/set	IXE	1208,50/set		
V-5510 70 Kg 50 Kg ▲ SLIDING 14/15										
A. 03		V-5510 SET 1 FIX	2000 mm	1 set	AN	414,30/set	IXE	478,30/set		
			3000 mm	1 set	AN	484,50/set	IXE	576,70/set		
			4000 mm	1 set	AN	553,50/set	IXE	675,00/set		
			1500 → 3000 mm	1 set	AN	543,00/set	IXE	646,30/set		
		V-5510 SET 1 MIS	3000 → 6000 mm	1 set	AN	782,70/set	IXE	985,00/set		
A. 04		V-5510 SET 2 FIX	3000 mm	1 set	AN	720,30/set	IXE	817,00/set		
			4000 mm	1 set	AN	789,70/set	IXE	915,30/set		
			6000 mm	1 set	AN	935,70/set	IXE	1119,30/set		
			1500 → 3000 mm	1 set	AN	778,00/set	IXE	882,00/set		
		V-5510 SET 2 MIS	3000 → 6000 mm	1 set	AN	1010,30/set	IXE	1208,50/set		
V-5503 70 Kg 70 Kg ▲ SLIDING 16/17										
A. 05		V-5503 SET 1 FIX	2000 mm	1 set	AN	433,00/set	IXE	495,50/set		
			3000 mm	1 set	AN	547,30/set	IXE	603,70/set		
			4000 mm	1 set	AN	592,70/set	IXE	712,00/set		
			6000 mm	1 set	AN	756,30/set	IXE	932,50/set		
		V-5503 SET 1 MIS	1500 → 3000 mm	1 set	AN	574,70/set	IXE	676,30/set		
			3000 → 6000 mm	1 set	AN	847,30/set	IXE	1044,70/set		
A. 06		V-5503 SET 2 FIX	3000 mm	1 set	AN	749,50/set	IXE	844,30/set		
			4000 mm	1 set	AN	829,30/set	IXE	952,30/set		
			6000 mm	1 set	AN	993,00/set	IXE	1172,50/set		
			1500 → 3000 mm	1 set	AN	809,70/set	IXE	911,70/set		
		V-5503 SET 2 MIS	3000 → 6000 mm	1 set	AN	1072,50/set	IXE	1266,30/set		

FIX

- Confezioni industriali
- Industrial packaging
- Industrieverpackungen
- Lunghezza fissa
- Fixed length
- Feste Länge

MIS

- Tagliato dal cliente
- Cut by installer
- Schnitt bauseitig

MIS

- Tagliato a misura del cliente
- Custom length
- Nach Mass geschnitten

- Confezioni profili con quantità fissa, disponibili solo in multipli della quantità indicata.
- Packs of profiles with fixed quantity, available only in multiples of the indicated quantity.
- Profilpackungen mit fixer Menge sind nur als Vielfaches der angeführten Menge erhältlich.

- Trasporto fuori standard. Vedi condizioni di vendita
- Non-standard transport. See sales conditions
- Sondertransport. Siehe AGB

POS.	PROD.	ART.	MIS.	Q.TÀ	FIN.	EURO	FIN.	EURO	FIN.	EURO
▲ SLIDING 16/17										
A. 07	<p>V-5513 SET 1 FIX</p>		2000 mm	1 set	AN	433,00 /set	IXE	495,50 /set		
			3000 mm	1 set	AN	547,30 /set	IXE	603,70 /set		
			4000 mm	1 set	AN	592,70 /set	IXE	712,00 /set		
			6000 mm	1 set	AN	756,30 /set	IXE	932,50 /set		
			1500 → 3000 mm	1 set	AN	574,70 /set	IXE	676,30 /set		
			3000 → 6000 mm	1 set	AN	847,30 /set	IXE	1044,70 /set		
A. 08	<p>V-5513 SET 2 FIX</p>		3000 mm	1 set	AN	749,50 /set	IXE	844,30 /set		
			4000 mm	1 set	AN	829,30 /set	IXE	952,30 /set		
			6000 mm	1 set	AN	993,00 /set	IXE	1172,50 /set		
			1500 → 3000 mm	1 set	AN	809,70 /set	IXE	911,70 /set		
			3000 → 6000 mm	1 set	AN	1072,50 /set	IXE	1266,30 /set		
			▲ SLIDING 18/19							
V-5500 / V-5510 / V-5503 / V-5513 COMPONENTI / COMPONENTS / EINZELTEILE										
A. 09	<p>V-5500</p>		2000 mm	1 pc	AN	166,50 /pc	IXE	227,70 /pc		
			3000 mm	1 pc	AN	235,70 /pc	IXE	326,30 /pc		
			4000 mm	1 pc	AN	305,70 /pc	IXE	425,00 /pc		
			6000 mm	1 pc	AN	451,70 /pc	IXE	628,70 /pc		
			1500 → 3000 mm	1 pc	AN	264,30 /pc	IXE	365,70 /pc		
			3000 → 6000 mm	1 pc	AN	506,00 /pc	IXE	704,30 /pc		
A. 10	<p>V-5503</p>	<p>IV-5500-CF</p>	2000 mm	■ min 6 pcs	AN	131,50 /pc	IXE	182,70 /pc		
			3000 mm	■ min 4 pcs	AN	185,00 /pc	IXE	261,30 /pc		
			2000 mm	1 pc	AN	196,30 /pc	IXE	255,50 /pc		
			3000 mm	1 pc	AN	276,00 /pc	IXE	364,30 /pc		
			4000 mm	1 pc	AN	356,30 /pc	IXE	472,30 /pc		
			6000 mm	1 pc	AN	520,00 /pc	IXE	693,00 /pc		
A. 10	<p>V-5503 MIS</p>		1500 → 3000 mm	1 pc	AN	309,00 /pc	IXE	408,00 /pc		
			3000 → 6000 mm	1 pc	AN	582,00 /pc	IXE	776,00 /pc		
A. 10	<p>IV-5503-CF</p>		2000 mm	■ min 6 pcs	AN	160,50 /pc	IXE	220,50 /pc		
			3000 mm	■ min 4 pcs	AN	230,70 /pc	IXE	319,70 /pc		

CF

- Prezzi speciali per l'acquisto delle quantità minime indicate (CF) dell'articolo. NB eventuali riordini o aggiunte per completamenti se di quantità inferiore alla minima, saranno fatturati al prezzo normale
- Special prices for the purchase of the minimum quantities indicated (CF) of the article. Note Well: any reorders or additions for completions of quantity less than the minimum will be invoiced at the normal price.
- Artikel mit Sonderpreisen bei Mindestabnahmemengen sind mit (CF) gekennzeichnet. Nachbestellungen oder Ergänzungen unter der Mindestabnahmemenge werden mit dem Normalpreis verrechnet.

POS.	PROD.	ART.	MIS.	Q.TÀ	FIN.	EURO	FIN.	EURO	FIN.	EURO
		IV-5500-BINARIO 	6000 mm 2 pcs		AN	244,00 /pc 40,67 /m	IXE	333,50 /pc 55,58 /m		
		IV-5503-BIN-FIX 	6000 mm 2 pcs		AN	349,50 /pc 58,25 /m	IXE	476,50 /pc 79,42 /m		
		IV-5500-VELETTA 	6000 mm 2 pcs		AN	93,00 /pc 15,50 /m	IXE	178,30 /pc 29,72 /m		
			<ul style="list-style-type: none"> • Veledda vendibile solo con binario di pari lunghezza, se acquistata sciolta va calcolata una maggiorazione di € 30,00 per ogni imballo. • Cover profile available only packed with rail profile. For profiles supplied without rails the extra cost for each package unit is € 30,00. • Profilabdeckung lieferbar nur mit Laufschiene verpackt. Aufpreis für Profilabdeckungen ohne Laufschiene ist € 30,00 pro Verpackungseinheit 							
		IV-5500-CLIP	(2 pc / m) min 12 pcs			1,70 /pc				
		MINIMO D'ORDINE: 2 profili da 6 mt (o multipli MINIMUM ORDER: No. 2 - 6 m profiles (or multiples MINDESTBESTELLMENGE: 2 Profile mit 6 m (nur als Vielfaches								
		TAGLIO-SCORR-UNI Costo per un taglio con misure uguali Cost for cut with same size Preis für einen Schnitt mit gleichen Maß				38,70 /pc				
A. 11		V-5502		1 set		125,70 /set				
		V-5502		min 5 set		100,30 /set				
A. 12		V-5506-70		1 set		94,70 /set	RECYCLING NEW MODEL V-5406-70 C ▶ 22			
		V-5506-70		min 5 set		81,30 /set				
A. 13		V-5501		2 pc	AN	11,00 /set	IXE	11,00 /set		
		V-5501		min 5 set	AN	8,00 /set	IXE	8,00 /set		
A. 14		V-012		1 pc	AN	18,30 /pc	NS	21,70 /pc	CR	21,70 /pc
		V-012		min 5 pcs	AN	12,50 /pc	NS	15,70 /pc	CR	15,70 /pc
A. 15		V-5507		2 pc		76,00 /set				
		V-5507		min 5 set		60,30 /set				

FIX
 • Confezioni industriali
 • Industrial packaging
 • Industrieverpackungen

FIX
 • Lunghezza fissa
 • Fixed length
 • Feste Länge

MIS
 • Tagliato dal cliente
 • Cut by installer
 • Schnitt bauseitig

MIS
 • Tagliato a misura del cliente
 • Custom length
 • Nach Mass geschnitten

!
 • Confezioni profili con quantità fissa, disponibili solo in multipli della quantità indicata.
 • Packs of profiles with fixed quantity, available only in multiples of the indicated quantity.
 • Profilpackungen mit fixer Menge sind nur als Vielfaches der angeführten Menge erhältlich.

!
 • Trasporto fuori standard. Vedi condizioni di vendita
 • Non-standard transport. See sales conditions
 • Sondertransport. Siehe AGB

POS.	PROD.	ART.	MIS.	Q.TÀ	FIN.	EURO	FIN.	EURO	FIN.	EURO		
A. 16		P-F08		1 pc		22,00 /pc						
		P-F08		■ min 5 pcs		17,00 /pc						
A. 17	 soft-close 50 Kg	V-5506-50		1 set		94,70 /set			FINE SERIE END OF SERIES AUSLAUFMODELL			
		V-5506-50		■ min 5 set		81,30 /set						
A. 18		V-5511		2 pc	AN	21,30 /set	IXE	27,00 /set				
		V-5511		■ min 5 set	AN	17,00 /set	IXE	21,30 /set				
A. 19	 OPTIONAL		VP-019-MT	1000 mm	1 pc		7,30 /pc					
				2000 mm	1 pc		5,30 /pc					
				3000 mm	1 pc		4,70 /pc					
				1000 mm	1 pc		7,30 /pc					
				2000 mm	1 pc		5,30 /pc					
				3000 mm	1 pc		4,70 /pc					

Esempio prezzi al set ricavati da profili con imballo industriale (■) tagliati dal cliente
Example of set prices calculated with profiles in industrial packaging (■), cut by the customer
Beispiel: Set-Preise berechnet mit industriell/verpackten Profile (■), Schnitt bauseitig

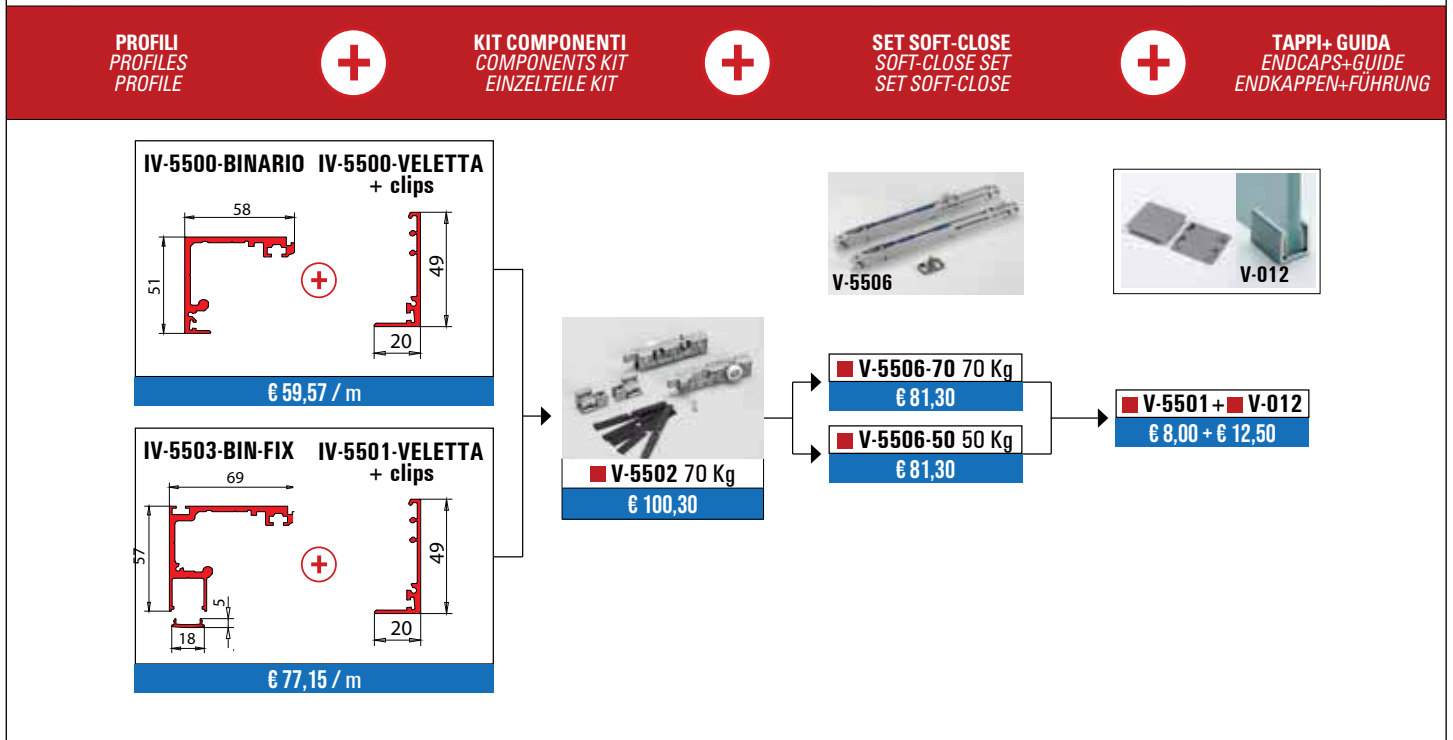

POS.	PROD.	ART.	MIS.	Q.TÀ	FIN.	EURO	FIN.	EURO	FIN.	EURO
EVOLUTION MINI SOFT-CLOSE										
V-5420 ▲ SLIDING 20/21										
A. 20		V-5420 SET 1 FIX	2000 mm	1 set	AN	513,50/set	IXE	570,70/set	NO	540,70/set
			3000 mm	1 set	AN	603,50/set	IXE	686,30/set	NO	640,70/set
			4000 mm	1 set	AN	702,00/set	IXE	810,00/set	NO	749,30/set
			1500 → 3000 mm	1 set	AN	675,70/set	IXE	769,00/set	NO	718,00/set
A. 21		V-5420 SET 2 FIX	3000 mm	1 set	AN	895,00/set	IXE	981,30/set	NO	935,00/set
			4000 mm	1 set	AN	993,00/set	IXE	1105,30/set	NO	1043,50/set
			6000 mm	1 set	AN	1172,30/set	IXE	1335,30/set	NO	1243,30/set
			1500 → 3000 mm	1 set	AN	967,00/set	IXE	1059,70/set	NO	1009,70/set
A. 22		V-5423 SET 1 MIS	2000 mm	1 set	AN	549,70/set	IXE	622,70/set	NO	579,00/set
			3000 mm	1 set	AN	658,30/set	IXE	765,00/set	NO	700,70/set
			4000 mm	1 set	AN	776,00/set	IXE	915,50/set	NO	831,00/set
			1500 → 3000 mm	1 set	AN	738,00/set	IXE	857,30/set	NO	785,30/set
A. 23		V-5423 SET 2 MIS	3000 mm	1 set	AN	950,30/set	IXE	1060,00/set	NO	973,50/set
			4000 mm	1 set	AN	1067,50/set	IXE	1210,00/set	NO	1124,70/set
			6000 mm	1 set	AN	1281,00/set	IXE	1489,70/set	NO	1362,30/set
			1500 → 3000 mm	1 set	AN	1026,50/set	IXE	1145,00/set	NO	1051,70/set
A. 24		V-5400 SET 1 FIX	2000 mm	1 set	AN	543,00/set	IXE	AIH /set	NO	570,00/set
			3000 mm	1 set	AN	633,30/set	IXE	716,30/set	NO	670,50/set
			4000 mm	1 set	AN	731,00/set	IXE	840,00/set	NO	779,00/set
			1500 → 3000 mm	1 set	AN	709,00/set	IXE	802,00/set	NO	751,00/set
A. 25		V-5400 SET 2 FIX	3000 mm	1 set	AN	954,00/set	IXE	1040,50/set	NO	994,30/set
			4000 mm	1 set	AN	1052,70/set	IXE	1164,30/set	NO	1103,00/set
			6000 mm	1 set	AN	1231,00/set	IXE	1394,70/set	NO	1302,30/set
			1500 → 3000 mm	1 set	AN	1030,50/set	IXE	1123,70/set	NO	1074,00/set
A. 25		V-5400 SET 2 MIS	3000 → 6000 mm	1 set	AN	1329,70/set	IXE	1506,30/set	NO	1406,30/set

FIX
 • Lunghezza fissa
 • Fixed length
 • Feste Länge

MIS
 • Tagliato dal cliente
 • Cut by installer
 • Schnitt bauseitig

MIS
 • Tagliato a misura del cliente
 • Custom length
 • Nach Mass geschnitten

MIS
 • Trasporto fuori standard. Vedi condizioni di vendita
 • Non-standard transport. See sales conditions
 • Sondertransport. Siehe AGB

POS.	PROD.	ART.	MIS.	Q.TÀ	FIN.	EURO	FIN.	EURO	FIN.	EURO
V-5403 ▲ SLIDING 24/25										
A. 26		V-5403 SET 1 FIX	2000 mm	1 set	AN	579,50/set	IXE	652,70/set	NO	609,00/set
			3000 mm	1 set	AN	688,50/set	IXE	794,70/set	NO	730,50/set
			4000 mm	1 set	AN	805,70/set	IXE	945,00/set	NO	860,00/set
			1500 → 3000 mm	1 set	AN	771,30/set	IXE	890,30/set	NO	818,00/set
			3000 → 6000 mm	1 set	AN	1140,70/set	IXE	1360,30/set	NO	1230,70/set
A. 27		V-5403 SET 2 FIX	3000 mm	1 set	AN	1009,70/set	IXE	1119,30/set	NO	1054,30/set
			4000 mm	1 set	AN	1127,00/set	IXE	1270,00/set	NO	1183,70/set
			6000 mm	1 set	AN	1340,70/set	IXE	1549,50/set	NO	1422,70/set
			1500 → 3000 mm	1 set	AN	1090,50/set	IXE	1209,00/set	NO	1070,00/set
			3000 → 6000 mm	1 set	AN	1448,00/set	IXE	1673,30/set	NO	1307,30/set
V-5410 ▲ SLIDING 20/21										
A. 28		V-5410 SET 1 FIX	2000 mm	1 set	AN	669,30/set	IXE	726,30/set	NO	696,30/set
			3000 mm	1 set	AN	759,30/set	IXE	842,30/set	NO	796,50/set
			4000 mm	1 set	AN	857,30/set	IXE	966,00/set	NO	905,00/set
			1500 → 3000 mm	1 set	AN	849,70/set	IXE	943,30/set	NO	892,00/set
			3000 → 6000 mm	1 set	AN	1160,50/set	IXE	1340,00/set	NO	1237,50/set
A. 29		V-5410 SET 2 FIX	3000 mm	1 set	AN	1206,30/set	IXE	1292,70/set	NO	1246,30/set
			4000 mm	1 set	AN	1304,70/set	IXE	1416,50/set	NO	1354,70/set
			6000 mm	1 set	AN	1483,50/set	IXE	1647,00/set	NO	1554,30/set
			1500 → 3000 mm	1 set	AN	1303,30/set	IXE	1396,50/set	NO	1346,30/set
			3000 → 6000 mm	1 set	AN	1602,00/set	IXE	1778,70/set	NO	1678,70/set
V-5413 ▲ SLIDING 24/25										
A. 30		V-5413 SET 1 FIX	2000 mm	1 set	AN	705,70/set	IXE	778,70/set	NO	734,70/set
			3000 mm	1 set	AN	814,50/set	IXE	921,00/set	NO	856,50/set
			4000 mm	1 set	AN	932,00/set	IXE	1071,30/set	NO	986,30/set
			1500 → 3000 mm	1 set	AN	912,50/set	IXE	1031,50/set	NO	959,30/set
			3000 → 6000 mm	1 set	AN	1282,70/set	IXE	1513,00/set	NO	1372,00/set
A. 31		V-5413 SET 2 FIX	3000 mm	1 set	AN	1262,00/set	IXE	1371,50/set	NO	1306,30/set
			4000 mm	1 set	AN	1379,30/set	IXE	1522,00/set	NO	1436,30/set
			6000 mm	1 set	AN	1635,30/set	IXE	1801,50/set	NO	1675,00/set
			1500 → 3000 mm	1 set	AN	1363,30/set	IXE	1481,30/set	NO	1411,00/set
			3000 → 6000 mm	1 set	AN	1766,30/set	IXE	1945,70/set	NO	1809,30/set

POS.	PROD.	ART.	MIS.	Q.TÀ	FIN.	EURO	FIN.	EURO	FIN.	EURO
V-5430 ▲ SLIDING 22/23										
A. 32		V-5430 SET 1 FIX	2000 mm	1 set	AN	441,00/set	IXE	498,30/set	NO	468,00/set
			3000 mm	1 set	AN	531,30/set	IXE	614,30/set	NO	568,50/set
			4000 mm	1 set	AN	629,00/set	IXE	738,00/set	NO	676,70/set
			1500 → 3000 mm	1 set	AN	595,00/set	IXE	687,50/set	NO	637,00/set
			3000 → 6000 mm	1 set	AN	905,00/set	IXE	1084,70/set	NO	981,30/set
A. 33		V-5430 SET 2 FIX	3000 mm	1 set	AN	750,30/set	IXE	836,50/set	NO	790,30/set
			4000 mm	1 set	AN	848,70/set	IXE	960,50/set	NO	898,70/set
			6000 mm	1 set	AN	1027,50/set	IXE	1190,50/set	NO	1098,30/set
			1500 → 3000 mm	1 set	AN	810,50/set	IXE	903,50/set	NO	854,00/set
			3000 → 6000 mm	1 set	AN	1109,50/set	IXE	1286,30/set	NO	1186,30/set
V-5433 ▲ SLIDING 26/27										
A. 34		V-5433 SET 1 FIX	2000 mm	1 set	AN	477,70/set	IXE	550,50/set	NO	506,70/set
			3000 mm	1 set	AN	586,50/set	IXE	693,00/set	NO	628,30/set
			4000 mm	1 set	AN	703,70/set	IXE	843,30/set	NO	758,30/set
			1500 → 3000 mm	1 set	AN	656,70/set	IXE	776,00/set	NO	703,70/set
			3000 → 6000 mm	1 set	AN	1027,00/set	IXE	1257,30/set	NO	1117,00/set
A. 35		V-5433 SET 2 FIX	3000 mm	1 set	AN	806,00/set	IXE	915,00/set	NO	850,30/set
			4000 mm	1 set	AN	923,30/set	IXE	1065,70/set	NO	980,00/set
			6000 mm	1 set	AN	1136,70/set	IXE	1345,30/set	NO	1218,50/set
			1500 → 3000 mm	1 set	AN	870,70/set	IXE	988,30/set	NO	918,30/set
			3000 → 6000 mm	1 set	AN	1227,30/set	IXE	1453,30/set	NO	1316,30/set
V-5450 ▲ SLIDING 22/23										
A. 36		V-5450 SET 1 FIX	2000 mm	1 set	AN	470,70/set	IXE	528,30/set	NO	498,00/set
			3000 mm	1 set	AN	560,50/set	IXE	644,00/set	NO	598,00/set
			4000 mm	1 set	AN	658,70/set	IXE	767,50/set	NO	706,30/set
			1500 → 3000 mm	1 set	AN	628,00/set	IXE	720,50/set	NO	670,00/set
			3000 → 6000 mm	1 set	AN	938,30/set	IXE	1117,70/set	NO	1015,00/set
A. 37		V-5450 SET 2 FIX	3000 mm	1 set	AN	809,70/set	IXE	896,30/set	NO	849,50/set
			4000 mm	1 set	AN	907,70/set	IXE	1020,00/set	NO	958,00/set
			6000 mm	1 set	AN	1086,50/set	IXE	1250,30/set	NO	1157,70/set
			1500 → 3000 mm	1 set	AN	874,30/set	IXE	968,00/set	NO	917,30/set
			3000 → 6000 mm	1 set	AN	1174,00/set	IXE	1350,00/set	NO	1250,30/set

- FIX**
- Confezioni industriali
 - Industrial packaging
 - Industrieverpackungen
 - Lunghezza fissa
 - Fixed length
 - Feste Länge

- MIS**
- Tagliato dal cliente
 - Cut by installer
 - Schnitt bauseitig

- MIS**
- Tagliato a misura del cliente
 - Custom length
 - Nach Mass geschnitten

-
- Confezioni profili con quantità fissa, disponibili solo in multipli della quantità indicata.
 - Packs of profiles with fixed quantity, available only in multiples of the indicated quantity.
 - Profilpackungen mit fixer Menge sind nur als Vielfaches der angeführten Menge erhältlich.

-
- Trasporto fuori standard. Vedi condizioni di vendita
 - Non-standard transport. See sales conditions
 - Sondertransport. Siehe AGB

POS.	PROD.	ART.	MIS.	Q.TÀ	FIN.	EURO	FIN.	EURO	FIN.	EURO
<div style="display: flex; justify-content: space-between; align-items: center;"> <div style="display: flex; align-items: center;"> </div> <div style="text-align: right;"> ▲ SLIDING 26/27 </div> </div>										
A. 38		V-5453 SET 1 FIX	2000 mm	1 set	AN	507,30 /set	IXE	580,30 /set	NO	537,00 /set
			3000 mm	1 set	AN	616,30 /set	IXE	722,30 /set	NO	658,00 /set
			4000 mm	1 set	AN	733,00 /set	IXE	872,70 /set	NO	788,00 /set
			1500 → 3000 mm	1 set	AN	690,70 /set	IXE	809,00 /set	NO	601,70 /set
			3000 → 6000 mm	1 set	AN	1060,50 /set	IXE	1290,70 /set	NO	1150,30 /set
A. 39		V-5453 SET 2 FIX	3000 mm	1 set	AN	865,00 /set	IXE	969,30 /set	NO	941,30 /set
			4000 mm	1 set	AN	982,30 /set	IXE	1125,00 /set	NO	1039,30 /set
			6000 mm	1 set	AN	1195,50 /set	IXE	1405,00 /set	NO	1278,00 /set
			1500 → 3000 mm	1 set	AN	934,30 /set	IXE	1047,00 /set	NO	1016,70 /set
			3000 → 6000 mm	1 set	AN	1291,70 /set	IXE	1517,00 /set	NO	1415,00 /set
<div style="display: flex; justify-content: space-between; align-items: center;"> <div> V-5400 / V-5450 / V-5403 / V-5453 / V-5410 / V-5413 <i>COMPONENTI / COMPONENTS / EINZELTEILE</i> </div> <div style="text-align: right;"> ▲ SLIDING 28/31 </div> </div>										
A. 40		V-5400	2000 mm	1 pc	AN	211,30 /pc	IXE	265,50 /pc	NO	233,30 /pc
			3000 mm	1 pc	AN	301,50 /pc	IXE	381,00 /pc	NO	333,30 /pc
			4000 mm	1 pc	AN	399,00 /pc	IXE	505,30 /pc	NO	441,70 /pc
			6000 mm	1 pc	AN	578,30 /pc	IXE	735,30 /pc	NO	641,30 /pc
			V-5400 MIS	1500 → 3000 mm	1 pc	AN	337,50 /pc	IXE	426,70 /pc	NO
3000 → 6000 mm	1 pc	AN		648,00 /pc	IXE	823,30 /pc	NO	718,50 /pc		
		IV-5400-CF	2000 mm	■ min 6 pc	AN	162,30 /pc	IXE	207,30 /pc		
			3000 mm	■ min 4 pc	AN	236,70 /pc	IXE	304,00 /pc		
A. 41		V-5403	2000 mm	1 pc	AN	258,50 /pc	IXE	328,30 /pc	NO	285,30 /pc
			3000 mm	1 pc	AN	367,30 /pc	IXE	470,30 /pc	NO	407,00 /pc
			4000 mm	1 pc	AN	484,50 /pc	IXE	621,00 /pc	NO	536,70 /pc
			6000 mm	1 pc	AN	697,00 /pc	IXE	900,30 /pc	NO	775,00 /pc
			V-5403 MIS	1500 → 3000 mm	1 pc	AN	411,30 /pc	IXE	527,00 /pc	NO
3000 → 6000 mm	1 pc	AN		781,00 /pc	IXE	1008,30 /pc	NO	868,70 /pc		
		IV-5403-CF	2000 mm	■ min 6 pcs	AN	192,70 /pc	IXE	245,00 /pc		
			3000 mm	■ min 4 pcs	AN	281,70 /pc	IXE	361,00 /pc		
		IV-5400-BINARIO	6000 mm	■ 2 pcs	AN	324,30 /pc 54,05 /m	IXE	412,70 /pc 68,78 /m		

CF

- Prezzi speciali per l'acquisto delle quantità minime indicate (CF) dell'articolo. NB eventuali riordini o aggiunte per completamenti se di quantità inferiore alla minima, saranno fatturati al prezzo normale
- Special prices for the purchase of the minimum quantities indicated (CF) of the article. Note Well: any reorders or additions for completions of quantity less than the minimum will be invoiced at the normal price.
- Artikel mit Sonderpreisen bei Mindestabnahmemengen sind mit (CF) gekennzeichnet. Nachbestellungen oder Ergänzungen unter der Mindestabnahmemenge werden mit dem Normalpreis verrechnet.

POS.	PROD.	ART.	MIS.	Q.TÀ	FIN.	EURO	FIN.	EURO	FIN.	EURO	
		IV-5403-BIN-FIX 	6000 mm	2 pcs	AN	434,30 /pc 72,38 /m	IXE	555,50 /pc 92,58 /m			
		IV-5400-VELETTA 	6000 mm	2 pcs	AN	114,00 /pc 19,00 /m	IXE	185,00 /pc 30,83 /m			
		IV-5407-VELETTA 	6000 mm	2 pcs	AN	140,30 /pc 23,38 /m					
		<ul style="list-style-type: none"> • Veledda vendibile solo con binario di pari lunghezza, se acquistata sciolta va calcolata una maggiorazione di € 30,00 per ogni imballo. • Cover profile available only packed with rail profile. For profiles supplied without rails the extra cost for each package unit is € 30,00. • Profilabdeckung lieferbar nur mit Laufschiene verpackt. Aufpreis für Profilabdeckungen ohne Laufschiene ist € 30,00 pro Verpackungseinheit 									
		MINIMO D'ORDINE: 2 profili da 6 mt (o multipli)						MINIMUM ORDER: No. 2 - 6 m profiles (or multiples)			
		MINDESTBESTELLMENGE: 2 Profile mit 6 m (nur als Vielfaches)									
		TAGLIO-SCORR-UNI Costo per un taglio con misure uguali Cost for cut with same size Preis für einen Schnitt mit gleichen Maß				38,70 /pc					
A. 42		V-5102		1 set		183,50 /set					
		V-5102		min 5 set		170,50 /set					
A. 43		V-5152		1 set		111,30 /set					
		V-5152		min 5 set		93,70 /set					
A. 44		V-5406-70 C		1 set		91,70 /set					
		V-5406-70 C		min 5 set		67,00 /set					
A. 45		V-5406		1 set		121,30 /set					
		V-5406		min 5 set		114,00 /set					
A. 46		V-5406-120		1 set		247,30 /set					
		V-5406-120		min 5 set		232,70 /set					

- Confezioni industriali
- Industrial packaging
- Industrieverpackungen

- FIX**
- Lunghezza fissa
 - Fixed length
 - Feste Länge

- MIS**
- Tagliato dal cliente
 - Cut by installer
 - Schnitt baueitig

- MIS**
- Tagliato a misura del cliente
 - Custom length
 - Nach Mass geschnitten

-
- Confezioni profili con quantità fissa, disponibili solo in multipli della quantità indicata.
 - Packs of profiles with fixed quantity, available only in multiples of the indicated quantity.
 - Profilpackungen mit fixer Menge sind nur als Vielfaches der angeführten Menge erhältlich.

-
- Trasporto fuori standard. Vedi condizioni di vendita
 - Non-standard transport. See sales conditions
 - Sondertransport. Siehe AGB

POS.	PROD.	ART.	MIS.	Q.TÀ	FIN.	EURO	FIN.	EURO	FIN.	EURO
A. 47		V-5401		2 pcs	AN	11,00 /set	IXE	11,00 /set	NO	14,00 /set
		V-5401		■ min 5 set	AN	8,00 /set	IXE	8,00 /set	NO	10,30 /set
A. 48		V-5411		2 pcs	AN	20,00 /set	IXE	20,00 /set	NO	23,00 /set
		V-5411		■ min 5 set	AN	15,70 /set	IXE	15,70 /set	NO	18,50 /set
A. 49		V-5107 Per / For / Für V-5102		1 set		52,00 /set				
		V-5107		■ min 5 set		41,30 /set				
A. 50		V-012		1 pc	AN	18,30 /pc	NS	21,70 /pc	CR	21,70 /pc
		V-012		■ min 5 pcs	AN	12,50 /pc	NS	15,70 /pc	CR	15,70 /pc
A. 51		V-012-EVO		1 pc	AN	23,70 /pc	NS	28,30 /pc	CR	31,30 /pc
			NO	28,30 /pc						
		V-012-EVO		■ min 5 pcs	AN	19,00 /pc	NS	22,30 /pc	CR	27,00 /pc
			NO	22,30 /pc						
A. 52		V-012-REG		1 pc	AN	28,00 /pc	NS	30,50 /pc	CR	33,30 /pc
		V-012-REG		■ min 5 pcs	AN	22,30 /pc	NS	24,70 /pc	CR	27,00 /pc
A. 53		V-012-INS		1 pc	AN	32,50 /pc	NS	35,00 /pc	CR	37,50 /pc
		V-012-INS		■ min 5 pcs	AN	26,00 /pc	NS	28,00 /pc	CR	30,00 /pc
A. 54		V-6006		1 pc	AN	61,50 /m	IXE	90,00 /m		

- Velella vendibile solo con binario di pari lunghezza, se acquistata sciolta va calcolata una maggiorazione di € 30,00 per ogni imballo.
- Cover profile available only packed with rail profile. For profiles supplied without rails the extra cost for each package unit is € 30,00.
- Profilabdeckung lieferbar nur mit Laufschiene verpackt. Aufpreis für Profilabdeckungen ohne Laufschiene ist € 30,00 pro Verpackungseinheit

POS.	PROD.	ART.	MIS.	Q.TÀ	FIN.	EURO	FIN.	EURO	FIN.	EURO	
A. 55		V-6007		2 pc	AN	44,00 /set	IXE	53,00 /set			
A. 56	 OPTIONAL	V-5408				14,70 /m					
		V-5408	■ min 50 m			9,30 /m					
A. 57		P-F08		1 pc		22,00 /pc					
		P-F08	■ min 5 pcs			17,00 /pc					
A. 58		VP-019-MT		1000 mm 1 pc		7,30 /pc					
				2000 mm 1 pc		5,30 /pc					
				3000 mm 1 pc		4,70 /pc					
		VP-018-MT		1000 mm 1 pc		7,30 /pc					
				2000 mm 1 pc		5,30 /pc					
				3000 mm 1 pc		4,70 /pc					
A. 59		V-5142		2 pc		183,70 /set					
		V-5142	■ min 5 set			153,70 /set					
A. 60		V-5307 Per / For / Für V-5102		2 pc		76,00 /set					
		V-5307 Per / For / Für V-5102	■ min 5 set			60,30 /set					
A. 61		V-5507 Per / For / Für V-5152		2 pc		76,00 /set					
		V-5507 Per / For / Für V-5152	■ min 5 set			60,30 /set					

FIX

- Lunghezza fissa
- Fixed length
- Feste Länge



- Tagliato dal cliente
- Cut by installer
- Schnitt bauseitig

MIS

- Tagliato a misura del cliente
- Custom length
- Nach Mass geschnitten



- Trasporto fuori standard. Vedi condizioni di vendita
- Non-standard transport. See sales conditions
- Sondertransport. Siehe AGB

POS. | PROD. | ART. | MIS. | Q.TÀ | FIN. | EURO | FIN. | EURO | FIN. | EURO

Esempio prezzi al set ricavati da profili con imballo industriale (■) tagliati dal cliente
Example of set prices calculated with profiles in industrial packaging (■), cut by the customer
Beispiel: Set-Preise berechnet mit industriell/verpackten Profile (■), Schnitt bauseitig

PROFILI
PROFILES
PROFILE

KIT COMPONENTI
COMPONENTS KIT
EINZELTEILE KIT

SET SOFT-CLOSE
SOFT-CLOSE SET
SET SOFT-CLOSE

TAPPI+ GUIDA
ENDCAPS+GUIDE
ENDKAPPEN+FUHRUNG

IV-5400 IV-5400-VELETTA

€ 73,05 / m

IV-5403 IV-5400-VELETTA

€ 91,38 / m

IV-7150 IV-7151-VELETTA

€ 82,89 / m

IV-7153 IV-7151-VELETTA

€ 109,47 / m



■ V-5102 120 Kg
€ 170,50

■ V-5406-120 120 Kg
€ 232,70

■ V-5406-80 80 Kg
€ 114,00

■ V-5406-70 C 70 Kg
€ 67,00

■ V-5401 + ■ V-012
€ 8,00+ € 12,50

■ V-5152 70 Kg
€ 93,70

■ V-5406-80 80 Kg
€ 114,00

■ V-5406-70 C 70 Kg
€ 67,00

■ V-5401 + ■ V-012
€ 8,00+ € 12,50

POS.	PROD.	ART.	MIS.	Q.TÀ	FIN.	EURO	FIN.	EURO	FIN.	EURO
EVOLUTION										
V-5100 ▲ SLIDING 32/33										
A. 62		V-5100 SET 1 FIX	2000 mm	1 set	AN	391,50 /set	IXE	446,70 /set		
			3000 mm	1 set	AN	467,50 /set	IXE	543,00 /set		
			4000 mm	1 set	AN	552,30 /set	IXE	648,00 /set		
		V-5100 SET 1 MIS	1500 → 3000 mm	1 set	AN	524,00 /set	IXE	607,70 /set		
			3000 → 6000 mm	1 set	AN	778,30 /set	IXE	931,30 /set		
A. 63		V-5100 SET 2 FIX	3000 mm	1 set	AN	668,50 /set	IXE	747,00 /set		
			4000 mm	1 set	AN	752,70 /set	IXE	851,50 /set		
		V-5100 SET 2 MIS	6000 mm	1 set	AN	895,70 /set	IXE	1036,00 /set		
			1500 → 3000 mm	1 set	AN	814,00 /set	IXE	920,30 /set		
			3000 → 6000 mm	1 set	AN	967,30 /set	IXE	1118,70 /set		
V-5150 ▲ SLIDING 32/33										
A. 64		V-5150 SET 1 FIX	2000 mm	1 set	AN	319,50 /set	IXE	374,30 /set		
			3000 mm	1 set	AN	395,50 /set	IXE	470,70 /set		
			4000 mm	1 set	AN	532,50 /set	IXE	575,70 /set		
		V-5150 SET 1 MIS	1500 → 3000 mm	1 set	AN	443,00 /set	IXE	527,00 /set		
			3000 → 6000 mm	1 set	AN	697,00 /set	IXE	850,30 /set		
A. 65		V-5150 SET 2 FIX	3000 mm	1 set	AN	524,00 /set	IXE	602,50 /set		
			4000 mm	1 set	AN	607,70 /set	IXE	707,30 /set		
		V-5150 SET 2 MIS	6000 mm	1 set	AN	751,00 /set	IXE	890,50 /set		
			1500 → 3000 mm	1 set	AN	566,30 /set	IXE	651,00 /set		
			3000 → 6000 mm	1 set	AN	811,30 /set	IXE	876,30 /set		
V-5103 ▲ SLIDING 34/35										
A. 66		V-5103 SET 1 FIX	2000 mm	1 set	AN	421,50 /set	IXE	494,30 /set		
			3000 mm	1 set	AN	513,50 /set	IXE	620,00 /set		
			4000 mm	1 set	AN	597,30 /set	IXE	632,30 /set		
		V-5103 SET 1 MIS	1500 → 3000 mm	1 set	AN	575,00 /set	IXE	694,00 /set		
			3000 → 6000 mm	1 set	AN	887,30 /set	IXE	1118,00 /set		
A. 67		V-5103 SET 2 FIX	3000 mm	1 set	AN	713,70 /set	IXE	823,30 /set		
			4000 mm	1 set	AN	798,00 /set	IXE	835,70 /set		
		V-5103 SET 2 MIS	6000 mm	1 set	AN	992,50 /set	IXE	1308,70 /set		
			1500 → 3000 mm	1 set	AN	771,00 /set	IXE	889,50 /set		
			3000 → 6000 mm	1 set	AN	1072,30 /set	IXE	1413,30 /set		

- FIX**
- Confezioni industriali
 - Industrial packaging
 - Industrieverpackungen
 - Lunghezza fissa
 - Fixed length
 - Feste Länge

- MIS**
- Tagliato dal cliente
 - Cut by installer
 - Schnitt bauseitig

- MIS**
- Tagliato a misura del cliente
 - Custom length
 - Nach Mass geschnitten

-
- Confezioni profili con quantità fissa, disponibili solo in multipli della quantità indicata.
 - Packs of profiles with fixed quantity, available only in multiples of the indicated quantity.
 - Profilpackungen mit fixer Menge sind nur als Vielfaches der angeführten Menge erhältlich.

-
- Trasporto fuori standard. Vedi condizioni di vendita solo in multipli della quantità indicata.
 - Non-standard transport. See sales conditions
 - Sondertransport. Siehe AGB

POS.	PROD.	ART.	MIS.	Q.TÀ	FIN.	EURO	FIN.	EURO	FIN.	EURO
▲ SLIDING 34/35										
A. 68		V-5153 SET 1 FIX	2000 mm	1 set	AN	349,30 /set	IXE	422,30 /set		
			3000 mm	1 set	AN	441,00 /set	IXE	547,30 /set		
			4000 mm	1 set	AN	524,70 /set	IXE	559,50 /set		
		V-5153 SET 1 MIS	1500 → 3000 mm	1 set	AN	493,70 /set	IXE	613,00 /set		
			3000 → 6000 mm	1 set	AN	806,00 /set	IXE	1037,00 /set		
A. 69		V-5153 SET 2 FIX	3000 mm	1 set	AN	477,70 /set	IXE	679,00 /set		
			4000 mm	1 set	AN	569,30 /set	IXE	691,30 /set		
			6000 mm	1 set	AN	653,00 /set	IXE	1057,50 /set		
		V-5153 SET 2 MIS	1500 → 3000 mm	1 set	AN	515,70 /set	IXE	732,00 /set		
			3000 → 6000 mm	1 set	AN	705,30 /set	IXE	1142,50 /set		
▲ SLIDING 36/39										
V-5100 / V-5150 / V-5103 / V-5153 COMPONENTI / COMPONENTS / EINZELTEILE										
A. 70		V-5100	2000 mm	1 pc	AN	181,00 /pc	IXE	223,70 /pc		
			3000 mm	1 pc	AN	257,30 /pc	IXE	320,50 /pc		
			4000 mm	1 pc	AN	341,00 /pc	IXE	425,00 /pc		
		V-5100 MIS	6000 mm	1 pc	AN	484,00 /pc	IXE	609,00 /pc		
			1500 → 3000 mm	1 pc	AN	287,70 /pc	IXE	358,70 /pc		
A. 71		V-5103	2000 mm	1 pc	AN	221,00 /pc	IXE	291,00 /pc		
			3000 mm	1 pc	AN	312,50 /pc	IXE	415,70 /pc		
			4000 mm	1 pc	AN	397,00 /pc	IXE	428,00 /pc		
		V-5103 MIS	6000 mm	1 pc	AN	591,30 /pc	IXE	794,30 /pc		
			1500 → 3000 mm	1 pc	AN	350,30 /pc	IXE	465,70 /pc		
A. 72		V-5102		1 set		183,50 /set				
		V-5102		min 5 set		170,50 /set				
A. 73		V-5152		1 set		111,30 /set				
		V-5152		min 5 set		93,70 /set				

POS.	PROD.	ART.	MIS.	Q.TÀ	FIN.	EURO	FIN.	EURO	FIN.	EURO
A. 74		V-5101		2 pcs	AN	10,70/set	IXE	19,30/set		
		V-5101		■ min 5 set	AN	8,00/set	IXE	15,70/set		
A. 75		V-5111		2 pcs	AN	10,70/set	IXE	19,30/set		
		V-5111		■ min 5 set	AN	8,00/set	IXE	15,70/set		
A. 76		V-012		1 pc	AN	18,30/pc	NS	21,70/pc	CR	21,70/pc
		V-012		■ min 5 pc	AN	12,50/pc	NS	15,70/pc	CR	15,70/pc
A. 77	<p>V-5107 Per / For / Für V-5102</p>			1 set		52,00/set				
				■ min 5 set		41,30/set				
A. 78		V-5006		1 pc	AN	31,30/pc	IXE	34,70/pc		
A. 79	<p>ESEMPIO APPLICAZIONE / EXAMPLE / BEISPIEL</p> <p>MURO WALL MOBILE SLIDING SCHEBETÜR FISSO FIXED SERIENTEIL MURO WALL</p> <p>Max 60kg</p>	V-5112		1 pc		97,30/pc				

POS.	PROD.	ART.	MIS.	Q.TÀ	FIN.	EURO	FIN.	EURO	FIN.	EURO
A. 80		V-5507 Per / For / Für V-5152		2 pcs	AN	76,00/set				
		V-5507 Per / For / Für V-5152		■ min 5 set		60,30/set				
A. 81		P-F08		1 pc		22,00/pc				
		P-F08		■ min 5 pc		17,00/pc				
A. 82		V-5110		1 set		412,50/set				
A. 83			1000 mm	1 pc		7,30/pc				
		VP-019-MT	2000 mm	1 pc		5,30/pc				
			3000 mm	1 pc		4,70/pc				
			1000 mm	1 pc		7,30/pc				
		VP-018-MT	2000 mm	1 pc		5,30/pc				
			3000 mm	1 pc		4,70/pc				

POS.	PROD.	ART.	MIS.	Q.TÀ	FIN.	EURO	FIN.	EURO	FIN.	EURO
EVOLUTION LEGNO FOR WOODEN DOOR / FÜR HOLZTÜR										
V-5140 ▲ SLIDING 36/39										
A. 84		V-5140 SET 1 FIX	2000 mm	1 set	AN	389,30/set	IXE	439,30/set		
			3000 mm	1 set	AN	463,70/set	IXE	533,30/set		
			4000 mm	1 set	AN	545,00/set	IXE	634,30/set		
			1500 → 3000 mm	1 set	AN	493,50/set	IXE	562,70/set		
A. 85		V-5140 SET 2 FIX	3000 mm	1 set	AN	666,30/set	IXE	736,30/set		
			4000 mm	1 set	AN	749,00/set	IXE	838,30/set		
			6000 mm	1 set	AN	887,70/set	IXE	1017,30/set		
			1500 → 3000 mm	1 set	AN	698,30/set	IXE	766,70/set		
		V-5140 SET 2 MIS	3000 → 6000 mm	1 set	AN	945,00/set	IXE	1081,00/set		

COMPACT H 45 (OPTIONAL SOFT-CLOSE)										
V-5045 ▲ SLIDING 40/41										
A. 93		V-5045 SET 1 FIX	2000 mm	1 set	AN	415,00/set	IXE	477,00/set	CR	477,00/set
			3000 mm	1 set	AN	490,50/set	IXE	578,30/set	CR	578,30/set
			4000 mm	1 set	AN	566,30/set	IXE	679,50/set	CR	679,50/set
			1500 → 3000 mm	1 set	AN	549,00/set	IXE	637,30/set	CR	637,30/set
A. 94		V-5045 SET 2 FIX	3000 mm	1 set	AN	665,50/set	IXE	755,00/set	CR	755,00/set
			4000 mm	1 set	AN	741,00/set	IXE	856,00/set	CR	856,00/set
			6000 mm	1 set	AN	907,50/set	IXE	1074,00/set	CR	1074,00/set
			1500 → 3000 mm	1 set	AN	724,00/set	IXE	813,50/set	CR	813,50/set
		V-5045 SET 2 MIS	3000 → 6000 mm	1 set	AN	1009,70/set	IXE	1176,30/set	CR	1176,30/set

V-5050 ▲ SLIDING 40/41										
A. 95		V-5050 SET 1 FIX	2000 mm	1 set	AN	391,30/set	IXE	453,00/set	CR	453,00/set
			3000 mm	1 set	AN	466,50/set	IXE	554,70/set	CR	554,70/set
			4000 mm	1 set	AN	542,00/set	IXE	655,70/set	CR	655,70/set
			1500 → 3000 mm	1 set	AN	525,30/set	IXE	613,00/set	CR	613,00/set
A. 96		V-5050 SET 2 FIX	3000 mm	1 set	AN	618,00/set	IXE	707,30/set	CR	707,30/set
			4000 mm	1 set	AN	693,00/set	IXE	808,00/set	CR	808,00/set
			6000 mm	1 set	AN	859,50/set	IXE	1026,00/set	CR	1026,00/set
			1500 → 3000 mm	1 set	AN	676,00/set	IXE	765,50/set	CR	765,50/set
		V-5050 SET 2 MIS	3000 → 6000 mm	1 set	AN	962,00/set	IXE	1128,30/set	CR	1128,30/set

FIX

- Confezioni industriali
- Industrial packaging
- Industrieverpackungen
- Lunghezza fissa
- Fixed length
- Feste Länge

MIS

- Tagliato dal cliente
- Cut by installer
- Schnitt bauseitig

MIS

- Tagliato a misura del cliente
- Custom length
- Nach Mass geschnitten

- Confezioni profili con quantità fissa, disponibili solo in multipli della quantità indicata.
- Packs of profiles with fixed quantity, available only in multiples of the indicated quantity.
- Profilpackungen mit fixer Menge sind nur als Vielfaches der angeführten Menge erhältlich.

- Trasporto fuori standard. Vedi condizioni di vendita
- Non-standard transport. See sales conditions
- Sondertransport. Siehe AGB

POS.	PROD.	ART.	MIS.	Q.TÀ	FIN.	EURO	FIN.	EURO	FIN.	EURO
		V-5045 / V-5050 <i>COMPONENTI / COMPONENTS / EINZELTEILE</i>		▲ SLIDING 44/45						
A. 97		V-5045	2000 mm	1 pc	AN	232,70 /pc	IXE	290,00 /pc		
			3000 mm	1 pc	AN	313,30 /pc	IXE	398,30 /pc		
			4000 mm	1 pc	AN	393,00 /pc	IXE	505,30 /pc		
			6000 mm	1 pc	AN	569,70 /pc	IXE	736,30 /pc		
		V-5045 MIS	1500 → 3000 mm	1 pc	AN	375,70 /pc	IXE	460,30 /pc		
			3000 → 6000 mm	1 pc	AN	678,50 /pc	IXE	845,30 /pc		
	IV-5045-CF	2000 mm	■ min 6 pcs	AN	151,70 /pc	IXE	225,30 /pc	CR	225,30 /pc	
		3000 mm	■ min 4 pcs	AN	219,50 /pc	IXE	329,70 /pc	CR	329,70 /pc	
	IV-5045-BINARIO	6000 mm	■ 2 pcs	AN	304,00 /pc 50,67 /m	IXE	427,50 /pc 71,25 /m	CR	427,50 /pc 71,25 /m	
	IV-5045-VELETTA	6000 mm	■ 2 pcs	AN	94,70 /pc 15,78 /m	IXE	187,30 /pc 31,22 /m	CR	187,30 /pc 31,22 /m	
<ul style="list-style-type: none"> • VeleTTa vendibile solo con binario di pari lunghezza, se acquistata sciolta va calcolata una maggiorazione di € 30,00 per ogni imballo. • Cover profile available only packed with rail profile. For profiles supplied without rails the extra cost for each package unit is € 30,00. • Profilabdeckung lieferbar nur mit Laufschiene verpackt. Aufpreis für Profilabdeckungen ohne Laufschiene ist € 30,00 pro Verpackungseinheit 										
		V-5045-CLIP	(2 pc / m)	■ min 12 pcs		1,70 /pc				
MINIMO D'ORDINE: 2 profili da 6 mt (o multipli) MINIMUM ORDER: No. 2 - 6 m profiles (or multiples) MINDESTBESTELLMENGE: 2 Profile mit 6 m (nur als Vielfaches)										
		TAGLIO-SCORR-UNI	Costo per un taglio con misure uguali Cost for cut with same size Preis für einen Schnitt mit gleichen Maß			38,70 /pc				
A. 98		V-5042		1 set		211,50 /set				
		V-5042		■ min 5 set		191,70 /set				
A. 99		V-5052		1 set		170,50 /set				
		V-5052		■ min 5 set		146,00 /set				
A. 100		V-5046-70 C		1 set		91,70 /set				
		V-5046-70 C		■ min 5 set		67,00 /set				

CF

- Prezzi speciali per l'acquisto delle quantità minime indicate (CF) dell'articolo. NB eventuali riordini o aggiunte per completamenti se di quantità inferiore alla minima, saranno fatturati al prezzo normale
- Special prices for the purchase of the minimum quantities indicated (CF) of the article. Note Well: any reorders or additions for completions of quantity less than the minimum will be invoiced at the normal price.
- Artikel mit Sonderpreisen bei Mindestabnahmemengen sind mit (CF) gekennzeichnet. Nachbestellungen oder Ergänzungen unter der Mindestabnahmemenge werden mit dem Normalpreis verrechnet.

POS.	PROD.	ART.	MIS.	Q.TÀ	FIN.	EURO	FIN.	EURO	FIN.	EURO
A. 101		V-5046-120		1 set		247,30 /set				
		V-5046-120	■ min 5 set			232,70 /set				
A. 102		V-012		1 pc	AN	18,30 /pc	NS	21,70 /pc	CR	21,70 /pc
		V-012	■ min 5 pc		AN	12,50 /pc	NS	15,70 /pc	CR	15,70 /pc
A. 103		V-5051		2 pc	AN	13,50 /set	IXE	29,00 /set	CR	29,00 /set
		V-5051	■ min 5 set		AN	11,30 /set	IXE	27,00 /set	CR	27,00 /set

COMPACT H 40 (OPTIONAL SOFT-CLOSE)

V-5040		▲ SLIDING 42/43								
A. 104		V-5040 SET 1 FIX	2000 mm	1 set	AN	380,00 /set	IXE	444,30 /set	CR	444,30 /set
			3000 mm	1 set	AN	448,00 /set	IXE	540,00 /set	CR	540,00 /set
			4000 mm	1 set	AN	515,70 /set	IXE	635,00 /set	CR	635,00 /set
		V-5040 SET 1 MIS	1500 → 3000 mm	1 set	AN	509,30 /set	IXE	600,70 /set	CR	600,70 /set
			3000 → 6000 mm	1 set	AN	765,50 /set	IXE	948,00 /set	CR	948,00 /set
A. 105		V-5040 SET 2 FIX	3000 mm	1 set	AN	624,00 /set	IXE	716,70 /set	CR	716,70 /set
			4000 mm	1 set	AN	691,50 /set	IXE	812,00 /set	CR	812,00 /set
			6000 mm	1 set	AN	834,30 /set	IXE	1018,30 /set	CR	1018,30 /set
		V-5040 SET 2 MIS	1500 → 3000 mm	1 set	AN	685,00 /set	IXE	777,70 /set	CR	777,70 /set
			3000 → 6000 mm	1 set	AN	941,00 /set	IXE	1125,00 /set	CR	1125,00 /set
V-5035		▲ SLIDING 42/43								
A. 106		V-5035 SET 1 FIX	2000 mm	1 set	AN	355,70 /set	IXE	420,30 /set	CR	420,30 /set
			3000 mm	1 set	AN	424,50 /set	IXE	516,00 /set	CR	516,00 /set
			4000 mm	1 set	AN	492,00 /set	IXE	611,30 /set	CR	611,30 /set
		V-5035 SET 1 MIS	1500 → 3000 mm	1 set	AN	485,00 /set	IXE	577,00 /set	CR	577,00 /set
			3000 → 6000 mm	1 set	AN	741,30 /set	IXE	924,50 /set	CR	924,50 /set
A. 107		V-5035 SET 2 FIX	3000 mm	1 set	AN	576,00 /set	IXE	669,30 /set	CR	669,30 /set
			4000 mm	1 set	AN	643,50 /set	IXE	764,00 /set	CR	764,00 /set
			6000 mm	1 set	AN	786,70 /set	IXE	970,30 /set	CR	970,30 /set
		V-5035 SET 2 MIS	1500 → 3000 mm	1 set	AN	637,00 /set	IXE	729,70 /set	CR	729,70 /set
			3000 → 6000 mm	1 set	AN	893,30 /set	IXE	1077,00 /set	CR	1077,00 /set











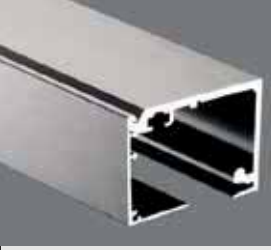

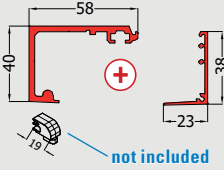
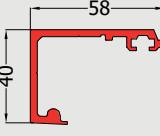

-
- Confezioni industriali
 - Industrial packaging
 - Industrieverpackungen
- FIX**
- Lunghezza fissa
 - Fixed length
 - Feste Länge

-
- Tagliato dal cliente
 - Cut by installer
 - Schnitt bauseitig

- MIS**
- Tagliato a misura del cliente
 - Custom length
 - Nach Mass geschnitten



-
- Confezioni profili con quantità fissa, disponibili solo in multipli della quantità indicata.
 - Packs of profiles with fixed quantity, available only in multiples of the indicated quantity.
 - Profilpackungen mit fixer Menge sind nur als Vielfaches der angeführten Menge erhältlich.

-
- Trasporto fuori standard. Vedi condizioni di vendita
 - Non-standard transport. See sales conditions
 - Sondertransport. Siehe AGB

POS.	PROD.	ART.	MIS.	Q.TÀ	FIN.	EURO	FIN.	EURO	FIN.	EURO
		V-5040 / V-5035 <i>COMPONENTI / COMPONENTS / EINZELTEILE</i>		▲ SLIDING 44/45						
A. 108		V-5040	2000 mm	1 pc	AN	194,30 /pc	IXE	255,00 /pc		
			3000 mm	1 pc	AN	266,70 /pc	IXE	357,00 /pc		
			4000 mm	1 pc	AN	338,50 /pc	IXE	457,30 /pc		
			 6000 mm	1 pc	AN	490,50 /pc	IXE	676,30 /pc		
		V-5040 MIS 	1500 → 3000 mm	1 pc	AN	561,30 /pc	IXE	659,00 /pc		
			3000 → 6000 mm	1 pc	AN	833,30 /pc	IXE	1027,50 /pc		
	IV-5040-CF	2000 mm	■ min 6 pcs	AN	137,30 /pc	IXE	210,50 /pc			
		3000 mm	■ min 4 pcs	AN	197,30 /pc	IXE	306,50 /pc			
	IV-5040-BINARIO	 6000 mm	■ 2 pcs	AN	262,00 /pc 43,67 /m	IXE	385,30 /pc 64,22 /m			
										
	IV-5040-VELETTA	 6000 mm	■ 2 pcs	AN	94,70 /pc 15,78 /m	IXE	187,30 /pc 31,22 /m			
										
<ul style="list-style-type: none"> • Velella vendibile solo con binario di pari lunghezza, se acquistata sciolta va calcolata una maggiorazione di € 30,00 per ogni imballo. • Cover profile available only packed with rail profile. For profiles supplied without rails the extra cost for each package unit is € 30,00. • Profilabdeckung lieferbar nur mit Laufschiene verpackt. Aufpreis für Profilabdeckungen ohne Laufschiene ist € 30,00 pro Verpackungseinheit 										
		V-5040-CLIP	(2 pc / m)	■ min 12 pcs		1,70 /pc				
<p>MINIMO D'ORDINE: 2 profili da 6 mt (o multipli ) MINIMUM ORDER: No. 2 - 6 m profiles (or multiples ) MINDESTBESTELLMENGE: 2 Profile mit 6 m (nur als Vielfaches )</p>										
		TAGLIO-SCORR-UNI Costo per un taglio con misure uguali Cost for cut with same size Preis für einen Schnitt mit gleichen Maß				38,70 /pc				
A. 109		V-5042		1 set		211,50 /set				
		V-5042		■ min 5 set		191,70 /set				
A. 110		V-5052		1 set		170,50 /set				
		V-5052		■ min 5 set		146,00 /set				

CF

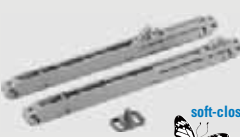
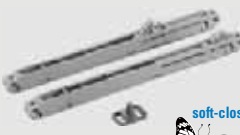

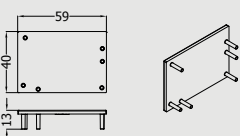
- Prezzi speciali per l'acquisto delle quantità minime indicate (CF) dell'articolo. NB eventuali riordini o aggiunte per completamenti se di quantità inferiore alla minima, saranno fatturati al prezzo normale
- Special prices for the purchase of the minimum quantities indicated (CF) of the article. Note Well: any reorders or additions for completions of quantity less than the minimum will be invoiced at the normal price.
- Artikel mit Sonderpreisen bei Mindestabnahmemengen sind mit (CF) gekennzeichnet. Nachbestellungen oder Ergänzungen unter der Mindestabnahmemenge werden mit dem Normalpreis verrechnet.

POS.	PROD.	ART.	MIS.	Q.TÀ	FIN.	EURO	FIN.	EURO	FIN.	EURO
A. 111	 soft-close 70 Kg	V-5036-70		1 set		101,30/set				
		V-5036-70		■ min 5 set		87,50/set				
A. 112	 soft-close 50 Kg	V-5036-50		1 set		101,30/set				
		V-5036-50		■ min 5 set		87,50/set				
A. 113		V-012		1 pc	AN	18,30/pc	NS	21,70/pc	CR	21,70/pc
		V-012		■ min 5 pc	AN	12,50/pc	NS	15,70/pc	CR	15,70/pc
A. 114		V-5041		2 pc	AN	23,00/set	IXE	29,50/set		
		V-5041		■ min 5 set	AN	20,30/set	IXE	27,30/set		

COMPACT

V-5000

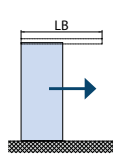
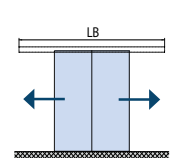
▲ SLIDING 46

A. 86		V-5000 SET 1 FIX	2000 mm	1 set	AN	694,70/set	IXE	860,50/set	FINE SERIE END OF SERIES AUSLAUFMODELL
			3000 mm	1 set	AN	783,70/set	IXE	1009,70/set	
			4000 mm	1 set	AN	882,50/set	IXE	1162,00/set	
			1500 → 3000 mm	1 set	AN	937,50/set	IXE	1108,30/set	
			3000 → 6000 mm	1 set	AN	1227,30/set	IXE	1625,70/set	
A. 87		V-5000 SET 2 FIX	3000 mm	1 set	AN	1162,00/set	IXE	1423,70/set	FINE SERIE END OF SERIES AUSLAUFMODELL
			4000 mm	1 set	AN	1262,30/set	IXE	1570,30/set	
			 6000 mm	1 set	AN	1440,30/set	IXE	1842,00/set	
			1500 → 3000 mm	1 set	AN	1252,30/set	IXE	1538,30/set	
			3000 → 6000 mm	1 set	AN	1607,70/set	IXE	2054,00/set	

- Confezioni industriali
- Industrial packaging
- Industrieverpackungen









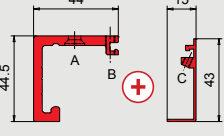
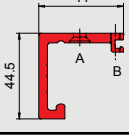

- FIX**
- Lunghezza fissa
 - Fixed length
 - Feste Länge

-  **MIS**
- Tagliato dal cliente
 - Cut by installer
 - Schnitt bauseitig

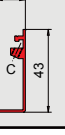
- MIS**
- Tagliato a misura del cliente
 - Custom length
 - Nach Mass geschnitten

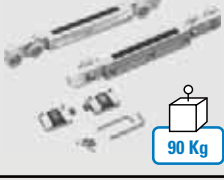
- 
- Confezioni profili con quantità fissa, disponibili solo in multipli della quantità indicata.
 - Packs of profiles with fixed quantity, available only in multiples of the indicated quantity.
 - Profilpackungen mit fixer Menge sind nur als Vielfaches der angeführten Menge erhältlich.

- 
- Trasporto fuori standard. Vedi condizioni di vendita
 - Non-standard transport. See sales conditions
 - Sondertransport. Siehe AGB

POS.	PROD.	ART.	MIS.	Q.TÀ	FIN.	EURO	FIN.	EURO	FIN.	EURO	
V-5000 ▲ SLIDING 47											
<i>COMPONENTI / COMPONENTS / EINZELTEILE</i>											
A. 88		V-5000	2000 mm	1 pc	AN	293,30 /pc	IXE	450,00 /pc	FINE SERIE END OF SERIES AUSLAUFMODELL		
			3000 mm	1 pc	AN	389,50 /pc	IXE	601,70 /pc			
			4000 mm	1 pc	AN	486,00 /pc	IXE	755,30 /pc			
			 6000 mm	1 pc	AN	662,00 /pc	IXE	1047,00 /pc			
		V-5000 MIS 	1500 → 3000 mm	1 pc	AN	572,00 /pc	IXE	803,00 /pc			
			3000 → 6000 mm	1 pc	AN	874,50 /pc	IXE	1288,00 /pc			
		IV-5000-CF	2000 mm	■ min 6 pcs	AN	171,50 /pc	IXE	237,30 /pc			
			3000 mm	■ min 4 pcs	AN	236,70 /pc	IXE	347,50 /pc			
		IV-5000 -BINARIO	 6000 mm	■ 2 pcs	AN	339,70 /pc 56,62 /m	IXE	444,30 /pc 74,05 /m			
		IV-5000-VELETTA	 6000 mm	■ 2 pcs	AN	115,00 /pc 19,17 /m	IXE	206,00 /pc 34,33 /m			
		<ul style="list-style-type: none"> • VeleTTa vendibile solo con binario di pari lunghezza, se acquistata sciolta va calcolata una maggiorazione di € 30,00 per ogni imballo. • Cover profile available only packed with rail profile. For profiles supplied without rails the extra cost for each package unit is € 30,00. • Profilabdeckung lieferbar nur mit Laufschiene verpackt. Aufpreis für Profilabdeckungen ohne Laufschiene ist € 30,00 pro Verpackungseinheit 									
		MINIMO D'ORDINE: 2 profili da 6 mt (o multipli ▲) MINIMUM ORDER: No. 2 - 6 m profiles (or multiples ▲) MINDESTBESTELLMENGE: 2 Profile mit 6 m (nur als Vielfaches ▲)									
		TAGLIO-SCORR-UNI	Costo per un taglio con misure uguali			38,70 /pc					
		Cost for cut with same size Preis für einen Schnitt mit gleichen Maß									
A. 89		V-5002	1 set			347,00 /set					
		V-5002	■ min 5 set			319,70 /set					
A. 90		V-012-EVO	1 pc		AN	23,70 /pc	NS	28,30 /pc	CR	31,30 /pc	
					NO	28,30 /pc					
		V-012-EVO	■ min 5 pc		AN	19,00 /pc	NS	22,30 /pc	CR	27,00 /pc	
					NO	22,30 /pc					
A. 91		V-5001	2 pc		AN	45,30 /set	IXE	54,70 /set			
		V-5001	■ min 5 set		AN	36,50 /set	IXE	43,50 /set			
A. 92		V-5006	1 pc		AN	31,30 /pc	IX	34,70 /pc			

POS. | PROD. | ART. | MIS. | Q.TÀ | FIN. | EURO | FIN. | EURO | FIN. | EURO

Esempio prezzi al set ricavati da profili con imballo industriale (■) tagliati dal cliente
Example of set prices calculated with profiles in industrial packaging (■), cut by the customer
Beispiel: Set-Preise berechnet mit industriell/verpackten Profile (■), Schnitt bauseitig

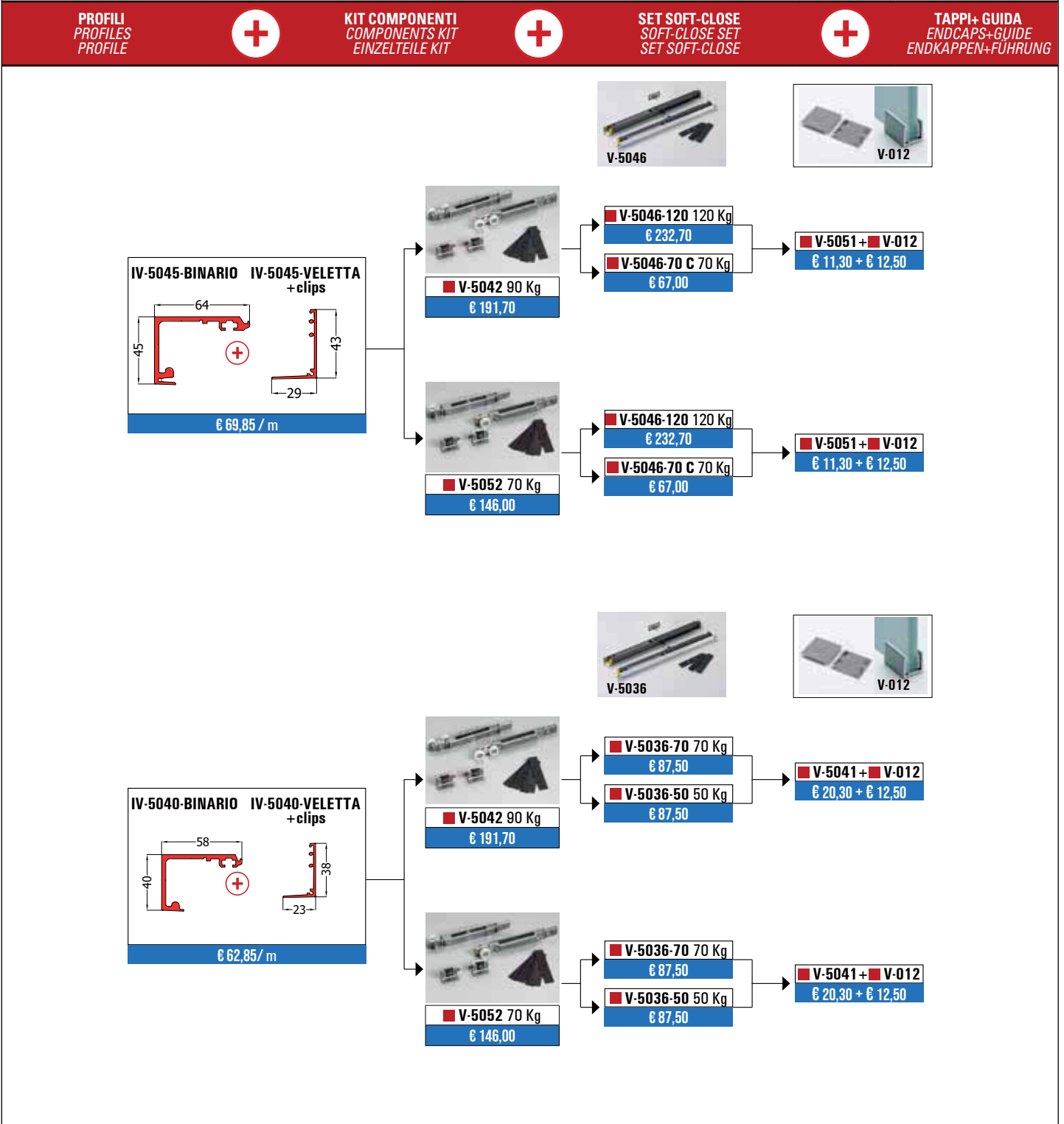











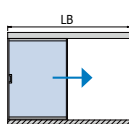

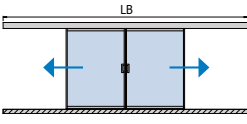



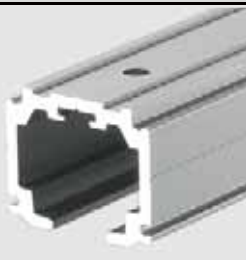

FIX
 • Lunghezza fissa
 • Fixed length
 • Feste Länge

• Tagliato dal cliente
 • Cut by installer
 • Schnitt bauseitig

MIS
 • Tagliato a misura del cliente
 • Custom length
 • Nach Mass geschnitten

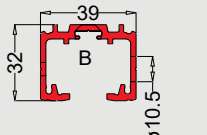
• Trasporto fuori standard. Vedi condizioni di vendita
 • Non-standard transport. See sales conditions
 • Sondertransport. Siehe AGB

POS.	PROD.	ART.	MIS.	Q.TÀ	FIN.	EURO	FIN.	EURO	FIN.	EURO
BRIXIA (OPTIONAL SOFT-CLOSE)										
V-1860 BRIXIA HEAVY ▲ SLIDING 52										
A. 115		V-1860 SET 1 FIX	2000 mm	1 set	AN	302,50/set	IXE	351,30/set		
			3000 mm	1 set	AN	351,30/set	IXE	408,00/set		
			4000 mm	1 set	AN	416,30/set	IXE	482,00/set		
			1500 → 3000 mm	1 set	AN	403,30/set	IXE	468,00/set		
			3000 → 6000 mm	1 set	AN	614,50/set	IXE	712,50/set		
A. 116		V-1860 SET 2 FIX	3000 mm	1 set	AN	491,70/set	IXE	580,50/set		
			4000 mm	1 set	AN	535,30/set	IXE	632,30/set		
			6000 mm	1 set	AN	665,30/set	IXE	785,50/set		
			1500 → 3000 mm	1 set	AN	536,70/set	IXE	633,50/set		
			3000 → 6000 mm	1 set	AN	747,70/set	IXE	882,50/set		
V-1863 BRIXIA HEAVY ▲ SLIDING 53										
A. 117		V-1863 SET 1 FIX	2000 mm	1 set	AN	416,30/set	IXE	487,00/set		
			3000 mm	1 set	AN	518,70/set	IXE	607,50/set		
			4000 mm	1 set	AN	641,70/set	IXE	750,30/set		
			1500 → 3000 mm	1 set	AN	577,70/set	IXE	676,00/set		
			3000 → 6000 mm	1 set	AN	935,70/set	IXE	1095,00/set		
A. 118		V-1863 SET 2 FIX	3000 mm	1 set	AN	651,30/set	IXE	762,30/set		
			4000 mm	1 set	AN	733,70/set	IXE	859,00/set		
			6000 mm	1 set	AN	1004,30/set	IXE	1175,70/set		
			1500 → 3000 mm	1 set	AN	711,30/set	IXE	833,30/set		
			3000 → 6000 mm	1 set	AN	1069,30/set	IXE	1251,30/set		
PO-290-BRIXIA ▲ SLIDING 54/55										
A. 119		PO-290-BRIXIA SET 1-P FIX	2000 mm	1 set	AN	778,70/set				
			3000 mm	1 set	AN	861,30/set				
			4000 mm	1 set	AN	947,70/set				
			1500 → 3000 mm	1 set	AN	906,70/set				
			3000 → 6000 mm	1 set	AN	1151,50/set				
A. 120		PO-290-BRIXIA SET 2-P FIX	3000 mm	1 set	AN	1393,70/set				
			4000 mm	1 set	AN	1465,70/set				
			6000 mm	1 set	AN	1665,30/set				
			1500 → 3000 mm	1 set	AN	1447,00/set				
			3000 → 6000 mm	1 set	AN	1691,30/set				

POS.	PROD.	ART.	MIS.	Q.TÀ	FIN.	EURO	FIN.	EURO	FIN.	EURO	
A. 121	 <p>Maniglia non inclusa Handle not included Griff nicht enthalten</p>	PO-290-BRIXIA SET 1-S FIX	2000 mm	1 set	AN	778,70/set					
			3000 mm	1 set	AN	861,30/set					
			4000 mm	1 set	AN	947,70/set					
		PO-290-BRIXIA SET 1-S MIS 	1500 → 3000 mm	1 set	AN	906,70/set					
			3000 → 6000 mm	1 set	AN	1151,50/set					
A. 122	 <p>Maniglia non inclusa Handle not included Griff nicht enthalten</p>	PO-290-BRIXIA SET 2-S FIX	3000 mm	1 set	AN	1393,70/set					
			4000 mm	1 set	AN	1465,70/set					
			 6000 mm	1 set	AN	1665,30/set					
		PO-290-BRIXIA SET 2-S MIS 	1500 → 3000 mm	1 set	AN	1447,00/set					
			3000 → 6000 mm	1 set	AN	1691,30/set					
A. 123	 <p>Maniglia non inclusa Handle not included Griff nicht enthalten</p>	PO-290-BRIXIA SET 5 FIX	2000 mm	1 set	AN	1447,00/set					
			3000 mm	1 set	AN	1570,00/set					
			4000 mm	1 set	AN	1692,30/set					
		PO-290-BRIXIA SET 5 MIS 	1500 → 3000 mm	1 set	AN	1627,70/set					
			3000 → 6000 mm	1 set	AN	2031,30/set					
V-1860 / V-1863 / PO-290-BRIXIA							▲ SLIDING 56/59				
COMPONENTI / COMPONENTS / EINZELTEILE											
A. 124		V-1860	2000 mm	1 pc	AN	117,00/pc					
			3000 mm	1 pc	AN	160,50/pc					
			4000 mm	1 pc	AN	204,30/pc					
		V-1860 MIS 	 6000 mm	1 pc	AN	288,70/pc					
			1500 → 3000 mm	1 pc	AN	186,30/pc					
A. 125		V-1834	2000 mm	1 pc	AN	147,30/pc	IXE	175,70/pc			
			3000 mm	1 pc	AN	201,00/pc	IXE	238,30/pc			
			4000 mm	1 pc	AN	255,00/pc	IXE	302,30/pc			
		V-1834 MIS 	 6000 mm	1 pc	AN	365,00/pc	IXE	437,30/pc			
			1500 → 3000 mm	1 pc	AN	243,30/pc	IXE	281,70/pc			
A. 126		V-1821	2000 mm	1 pc	AN	70,50/pc	IXE	120,30/pc			
			3000 mm	1 pc	AN	97,00/pc	IXE	162,50/pc			
			4000 mm	1 pc	AN	122,00/pc	IXE	211,30/pc			
		V-1821 MIS 	 6000 mm	1 pc	AN	153,00/pc	IXE	300,00/pc			
			1500 → 3000 mm	1 pc	AN	152,70/pc	IXE	217,00/pc			
		IV-1860	3000 mm	 4 pcs	AN	120,50/pc					
			 6000 mm	 2 pcs	AN	236,30/pc					

• Velella vendibile solo con binario di pari lunghezza, se acquistata sciolta va calcolata una maggiorazione di € 30,00 per ogni imballo.
 • Cover profile available only packed with rail profile. For profiles supplied without rails the extra cost for each package unit is € 30,00.
 • Profilabdeckung lieferbar nur mit Laufschiene verpackt. Aufpreis für Profilabdeckungen ohne Laufschienen ist € 30,00 pro Verpackungseinheit

 **FIX**
 • Confezioni industriali
 • Industrial packaging
 • Industrieverpackungen

• Lunghezza fissa
 • Fixed length
 • Feste Länge

 **MIS**
 • Tagliato dal cliente
 • Cut by installer
 • Schnitt bauseitig

• Tagliato a misura del cliente
 • Custom length
 • Nach Mass geschnitten

 **!**
 • Confezioni profili con quantità fissa, disponibili solo in multipli della quantità indicata.
 • Packs of profiles with fixed quantity, available only in multiples of the indicated quantity.
 • Profilpackungen mit fixer Menge sind nur als Vielfaches der angeführten Menge erhältlich.

 **!**
 • Trasporto fuori standard. Vedi condizioni di vendita
 • Non-standard transport. See sales conditions
 • Sondertransport. Siehe AGB

POS.	PROD.	ART.	MIS.	Q.TÀ	FIN.	EURO	FIN.	EURO	FIN.	EURO
		IV-1821	3000 mm	■ 4 pcs	AN	59,30 /pc	IXE	90,50 /pc		
				6000 mm	■ 2 pcs	AN	96,00 /pc	IXE	169,30 /pc	
<ul style="list-style-type: none"> • Veletta vendibile solo con binario di pari lunghezza, se acquistata sciolta va calcolata una maggiorazione di € 30,00 per ogni imballo. • Cover profile available only packed with rail profile. For profiles supplied without rails the extra cost for each package unit is € 30,00. • Profilabdeckung lieferbar nur mit Laufschiene verpackt. Aufpreis für Profilabdeckungen ohne Laufschienen ist € 30,00 pro Verpackungseinheit 										
		IV-1834	3000 mm	■ 4 pcs	AN	167,00 /pc	IXE	203,00 /pc		
				6000 mm	■ 2 pcs	AN	309,70 /pc	IXE	385,30 /pc	
		CLIPS BRIXIA	(2 pc / m)	■ 12 pcs	AN	19,30 /set 1,61 /pc				
<p>MINIMO D'ORDINE: 2 profili da 6 mt o 4 profili da 3 mt. (o multipli), anche assortiti tra i vari modelli MINIMUM ORDER: No. 2 - 6 m profiles, or No. 4 - 3 m profiles, (or multiples), also in combination of different models. MINDESTBESTELLMENGE: 2 Profile mit 6 m oder 4 Profile mit 3 m (nur als Vielfaches), auch sortiert nach den verschiedenen Modellen.</p>										
		TAGLIO-SCORR-UNI	Costo per un taglio con misure uguali Cost for cut with same size Preis für einen Schnitt mit gleichen Maß				38,70 /pc			
A. 127		V-1862		1 set		160,00 /set				
		V-1862		■ min 5 set		133,70 /set				
A. 128		V-1824-70		1 pc		93,00 /pc				
		V-1824-70		■ min 5 pc		80,30 /set				
A. 129		V-1824-50		1 pc		93,00 /pc				
		V-1824-50		■ min 5 pc		80,30 /set				
A. 130		V-012		1 pc	AN	18,30 /pc	NS	21,70 /pc	CR	21,70 /pc
		V-012		■ min 5 pc	AN	12,50 /pc	NS	15,70 /pc	CR	15,70 /pc
A. 131		V-1868		2 pcs	AN	11,00 /set	IXE	14,30 /set		
		V-1868		■ min 5 set	AN	8,00 /set	IXE	11,30 /set		
A. 132		V-090		1 pc		59,00 /pc				
		V-090		■ min 10 pcs		47,30 /pc				
		V-090		■ min 20 pcs		40,70 /pc				

POS.	PROD.	ART.	MIS.	Q.TÀ	FIN.	EURO	FIN.	EURO	FIN.	EURO
A. 133		V-1817-A / V-1817-B / V-1817-C		1 set	A	33,50/set	B	33,50/set	C	33,50/set
		V-1817-A / V-1817-B / V-1817-C								
A. 134		V-1865		2 pc	AN	26,30/set	IXE	33,50/set		
		V-1865		■ min 5 set	AN	22,30/set	IXE	28,70/set		
A. 135		V-1867		1 pc x 400 mm	1 pc	26,30/pc				
		V-1867		■ min 10 pcs		19,30/pc				
A. 136		V-1817		2 pc	AN	20,30/set				
		V-1817		■ min 5 set	AN	14,70/set				
A. 137		V-1816		1 pc	AN	54,30/pc				
		V-1816		■ min 10 pc		34,70/pc				
A. 138		VP-019-MT		1000 mm	1 pc	7,30/pc				
		VP-019-MT		2000 mm	1 pc	5,30/pc				
		VP-019-MT		3000 mm	1 pc	4,70/pc				
		VP-018-MT		1000 mm	1 pc	7,30/pc				
		VP-018-MT		2000 mm	1 pc	5,30/pc				
		VP-018-MT		3000 mm	1 pc	4,70/pc				
A. 139		PO-290-BRIXIA	max LM 1200 mm x HM 3000 mm	1 set	AN	636,50/set	NO*	763,70/set		

- FIX**
- Confezioni industriali
 - Industrial packaging
 - Industrieverpackungen
 - Lunghezza fissa
 - Fixed length
 - Feste Länge

- MIS**
- Tagliato dal cliente
 - Cut by installer
 - Schnitt bauseitig

- MIS**
- Tagliato a misura del cliente
 - Custom length
 - Nach Mass geschnitten

- !**
- Confezioni profili con quantità fissa, disponibili solo in multipli della quantità indicata.
 - Packs of profiles with fixed quantity, available only in multiples of the indicated quantity.
 - Profilpackungen mit fixer Menge sind nur als Vielfaches der angeführten Menge erhältlich.

- TRASPORTO**
- Trasporto fuori standard. Vedi condizioni di vendita
 - Non-standard transport. See sales conditions
 - Sondertransport. Siehe AGB

POS.	PROD.	ART.	MIS.	Q.TÀ	FIN.	EURO	FIN.	EURO	FIN.	EURO
A. 140		V-1827	2000 mm	1 pc	AN	62,70 /pc	NO*	81,30 /pc		
			3000 mm	1 pc	AN	80,00 /pc	NO*	104,00 /pc		
			4000 mm	1 pc	AN	105,30 /pc	NO*	137,30 /pc		
			6000 mm	1 pc	AN	173,00 /pc	NO*	224,50 /pc		
		V-1827 MIS	1500 → 3000 mm	1 pc	AN	140,30 /pc	NO*	182,70 /pc		
			3000 → 6000 mm	1 pc	AN	235,50 /pc	NO*	306,00 /pc		
	IV-1827	3000 mm	4 pcs	AN	62,70 /pc	NO*	85,00 /pc			
		6000 mm	2 pcs	AN	116,00 /pc	NO*	161,50 /pc			
<p>MINIMO D'ORDINE: 2 profili da 6 mt o 4 profili da 3 mt. (o multipli), anche assortiti tra i vari modelli MINIMUM ORDER: No. 2 - 6 m profiles, or No. 4 - 3 m profiles, (or multiples), also in combination of different models. MINDESTBESTELLMENGE: 2 Profile mit 6 m oder 4 Profile mit 3 m (nur als Vielfaches), auch sortiert nach den verschiedenen Modellen.</p>										
		TAGLIO-SCORR-UNI Costo per un taglio con misure uguali Cost for cut with same size Preis für einen Schnitt mit gleichen Maß				38,70 /pc				
A. 141		F-007		1 pair	AN	86,30 /pair	NO*	102,50 /pair		
		F-007		min 5 pairs	AN	61,00 /pair	NO*	72,50 /pair		
A. 142		V-1829-CF2	2000 mm	2 pc	AN	83,00 /2 pc	NO*	108,00 /2 pc		
			3000 mm	2 pc	AN	109,50 /2 pc	NO*	142,70 /2 pc		
			4000 mm	2 pc	AN	135,70 /2 pc	NO*	176,30 /2 pc		
			6000 mm	2 pc	AN	181,70 /2 pc	NO*	236,30 /2 pc		
		V-1829-CF2 MIS	1500 → 3000 mm	2 pc	AN	153,50 /2 pc	NO*	198,70 /2 pc		
			3000 → 6000 mm	2 pc	AN	247,30 /2 pc	NO*	321,50 /2 pc		
<ul style="list-style-type: none"> • Velella vendibile solo con binario di pari lunghezza, se acquistata sciolta va calcolata una maggiorazione di € 30,00 per ogni imballo. • Cover profile available only packed with rail profile. For profiles supplied without rails the extra cost for each package unit is € 30,00. • Profilabdeckung lieferbar nur mit Laufschiene verpackt. Aufpreis für Profilabdeckungen ohne Laufschiene ist € 30,00 pro Verpackungseinheit 										
	IV-1829	3000 mm	4 pcs	AN	44,00 /pc	NO*	60,00 /pc			
		6000 mm	2 pcs	AN	77,50 /pc	NO*	122,50 /pc			
<ul style="list-style-type: none"> • Velella vendibile solo con binario di pari lunghezza, se acquistata sciolta va calcolata una maggiorazione di € 30,00 per ogni imballo. • Cover profile available only packed with rail profile. For profiles supplied without rails the extra cost for each package unit is € 30,00. • Profilabdeckung lieferbar nur mit Laufschiene verpackt. Aufpreis für Profilabdeckungen ohne Laufschiene ist € 30,00 pro Verpackungseinheit 										
		TAGLIO-SCORR-UNI Costo per un taglio con misure uguali Cost for cut with same size Preis für einen Schnitt mit gleichen Maß				38,70 /pc				
<p>MINIMO D'ORDINE: 2 profili da 6 mt o 4 profili da 3 mt. (o multipli), anche assortiti tra i vari modelli MINIMUM ORDER: No. 2 - 6 m profiles, or No. 4 - 3 m profiles, (or multiples), also in combination of different models. MINDESTBESTELLMENGE: 2 Profile mit 6 m oder 4 Profile mit 3 m (nur als Vielfaches), auch sortiert nach den verschiedenen Modellen.</p>										
A. 143		V-1818-P		2 pc	AN	23,00 /set	NO*	30,50 /set		
		V-1818-P		min 5 set	AN	19,70 /pc	NO*	24,70 /pc		

CF

- Prezzi speciali per l'acquisto delle quantità minime indicate (CF) dell'articolo. NB eventuali riordini o aggiunte per completamenti se di quantità inferiore alla minima, saranno fatturati al prezzo normale
- Special prices for the purchase of the minimum quantities indicated (CF) of the article. Note Well: any reorders or additions for completions of quantity less than the minimum will be invoiced at the normal price.
- Artikel mit Sonderpreisen bei Mindestabnahmemengen sind mit (CF) gekennzeichnet. Nachbestellungen oder Ergänzungen unter der Mindestabnahmemenge werden mit dem Normalpreis verrechnet.

NO* Nero opaco - Matt black - Schwarz matt

- Disponibilità da verificare con ufficio commerciale
- Availability to be checked with sales office
- Die Verfügbarkeit ist mit dem Verkaufsbüro abzustimmen

POS.	PROD.	ART.	MIS.	Q.TÀ	FIN.	EURO	FIN.	EURO	FIN.	EURO	
A. 144		P-202 MIS		1 pc	AN	81,70/m	NO*	94,30/m			
A. 145		P-203 MIS		1 pc	AN	90,00/m	NO*	108,00/m			
A. 146		P-205 MIS		1 pc	AN	75,70/m	NO*	87,00/m			
A. 147		P-202 B	6000 mm	1 pc	AN	411,00/pc 68,50/m	NO*	492,00/pc 82,00/m			
		SECTOR 4P IP-202		3000 mm	4 pcs	AN	147,30/pc 49,10/m	NO*	176,00/pc 58,67/m		
			6000 mm	2 pcs	AN	286,70/pc 47,78/m	NO*	344,00/pc 57,33/m			
<p>MINIMO D'ORDINE: 2 profili da 6 mt o 4 profili da 3 mt. (o multipli ▲), anche assortiti tra i vari modelli MINIMUM ORDER: No. 2 - 6 m profiles, or No. 4 - 3 m profiles, (or multiples ▲), also in combination of different models. MINDESTBESTELLMENGE: 2 Profile mit 6 m oder 4 Profile mit 3 m (nur als Vielfaches ▲), auch sortiert nach den verschiedenen Modellen.</p>											
A. 148		P-203 B	6000 mm	1 pc	AN	480,00/pc 80,00/m	NO*	687,00/pc 114,50/m			
		SECTOR 4P IP-203		3000 mm	4 pcs	AN	117,50/pc 39,17/m	NO*	141,00/pc 47,00/m		
			6000 mm	2 pcs	AN	227,30/pc 37,88/m	NO*	277,30/pc 46,22/m			
		SECTOR 4P IP-203-VELETTA		3000 mm	4 pcs	AN	52,00/pc 17,33/m	NO*	67,70/pc 22,57/m		
	6000 mm	2 pcs	AN	90,00/pc 15,00/m	NO*	116,70/pc 19,45/m					
<ul style="list-style-type: none"> • Veledda vendibile solo con binario di pari lunghezza, se acquistata sciolta va calcolata una maggiorazione di € 30,00 per ogni imballo. • Cover profile available only packed with rail profile. For profiles supplied without rails the extra cost for each package unit is € 30,00. • Profilabdeckung lieferbar nur mit Laufschiene verpackt. Aufpreis für Profilabdeckungen ohne Laufschiene ist € 30,00 pro Verpackungseinheit 											
A. 149		P-205 B	6000 mm	1 pc	AN	385,80/pc 64,30/m	NO*	462,00/pc 77,00/m			
		SECTOR 4P IP-205		3000 mm	4 pcs	AN	122,00/pc 40,67/m	NO*	146,70/pc 48,90/m		
			6000 mm	2 pcs	AN	236,50/pc 39,42/m	NO*	284,30/pc 47,38/m			
<p>MINIMO D'ORDINE: 2 profili da 6 mt o 4 profili da 3 mt. (o multipli ▲), anche assortiti tra i vari modelli MINIMUM ORDER: No. 2 - 6 m profiles, or No. 4 - 3 m profiles, (or multiples ▲), also in combination of different models. MINDESTBESTELLMENGE: 2 Profile mit 6 m oder 4 Profile mit 3 m (nur als Vielfaches ▲), auch sortiert nach den verschiedenen Modellen.</p>											

FIX

- Confezioni industriali
- Industrial packaging
- Industrieverpackungen
- Lunghezza fissa
- Fixed length
- Feste Länge

MIS

- Tagliato dal cliente
- Cut by installer
- Schnitt bauseitig

MIS

- Tagliato a misura del cliente
- Custom length
- Nach Mass geschnitten

▲

- Confezioni profili con quantità fissa, disponibili solo in multipli della quantità indicata.
- Packs of profiles with fixed quantity, available only in multiples of the indicated quantity.
- Profilpackungen mit fixer Menge sind nur als Vielfaches der angeführten Menge erhältlich.

TRUCK

- Trasporto fuori standard. Vedi condizioni di vendita
- Non-standard transport. See sales conditions
- Sondertransport. Siehe AGB

POS.	PROD.	ART.	MIS.	Q.TÀ	FIN.	EURO	FIN.	EURO	FIN.	EURO	
A. 150											
A. 151		PO-292-BRIXIA		1 set	AN	160,00 /set					
		PO-292-BRIXIA		■ min 5 set	AN	130,00 /set					
A. 152	 Biadesivo preinstallato Pre-installed double-side adhesive Selbstklebend	DIV-204-MIX	995 mm	1 pc	AN	46,70 /pc	NO*	54,70 /pc			
			1495 mm	1 pc	AN	52,00 /pc	NO*	62,30 /pc			
			2980 mm	1 pc	AN	68,70 /pc	NO*	81,70 /pc			
		SECTOR 4P	IDIV-204-12 MIX	2980 mm	■ mix 12 pcs	AN	60,00 /pc	NO*	66,50 /pc		
		IDIV-204-30 MIX	2980 mm	■ mix 30 pcs	AN	53,00 /pc	NO*	59,00 /pc			
IDIV-204-80 MIX	2980 mm	■ mix 80 pcs	AN	43,50 /pc	NO*	47,70 /pc					
<ul style="list-style-type: none"> • DIV-204 prezzo valido solo con l'acquisto di un'anta PO-290, se acquistato sciolto va calcolata una maggiorazione di € 20,00 per ogni imballo • DIV-204 price valid only for item packed with one panel PO-290. For DIV-204 profiles supplied without PO-290 frames the extra cost for each package unit in € 20,00 • DIV-204 Preis gültig nur mit PO-290 Rahmenprofile verpackt. Aufpreis für DIV-204 Profile ohne PO-290 Rahmenprofile ist € 20,00 pro Verpackungseinheit 											
A. 153		P-F25		1 set		86,00 /set					
		IP-F25		■ min 5 set		70,30 /set					
A. 154		PO-292-TS4		1 set		144,70 /set					
		IPO-292-TS4		■ min 5 set	AN	126,30 /set					
A. 155		PO-290-TS4	max 1200 x 3000 mm	1 set	AN	570,00 /set	NO*	684,30 /set			

BRIXIA 50 SOFT-CLOSE										
<div style="display: flex; justify-content: space-between; align-items: center;"> <div style="display: flex; align-items: center;"> <div style="text-align: center;"> V-1840 50 Kg </div> <div style="text-align: center;"> soft-close 50 Kg </div> </div> <div style="text-align: right;"> ▲ SLIDING 48/49 </div> </div>										
A. 156		V-1840 SET 1 FIX	2000 mm	1 set	AN	269,30 /set	IXE	295,50 /set		
		V-1840 SET 1 FIX	3000 mm	1 set	AN	316,30 /set	IXE	351,30 /set		
		V-1840 SET 1 MIS	1500 → 3000 mm	1 set	AN	422,30 /set	IXE	460,30 /set		

CF

• Prezzi speciali per l'acquisto delle quantità minime indicate (CF) dell'articolo. NB eventuali riordini o aggiunte per completamenti se di quantità inferiore alla minima, saranno fatturati al prezzo normale
 • Special prices for the purchase of the minimum quantities indicated (CF) of the article. Note Well: any reorders or additions for completions of quantity less than the minimum will be invoiced at the normal price.
 • Artikel mit Sonderpreisen bei Mindestabnahmemengen sind mit (CF) gekennzeichnet. Nachbestellungen oder Ergänzungen unter der Mindestabnahmemenge werden mit dem Normalpreis verrechnet.

NO* Nero opaco - Matt black - Schwarz matt

• Disponibilità da verificare con ufficio commerciale
 • Availability to be checked with sales office
 • Die Verfügbarkeit ist mit dem Verkaufsbüro abzustimmen

POS.	PROD.	ART.	MIS.	Q.TÀ	FIN.	EURO	FIN.	EURO	FIN.	EURO
A. 157		V-1840 SET 2 FIX	2000 mm	1 set	AN	400,70/set	IXE	429,30/set		
			3000 mm	1 set	AN	448,00/set	IXE	483,70/set		
			4000 mm	1 set	AN	492,50/set	IXE	538,30/set		
		V-1840 SET 2 MIS	1500 → 3000 mm	1 set	AN	573,00/set	IXE	611,70/set		
V-1840 COMPONENTI / COMPONENTS / EINZELTEILE ▲ SLIDING 50/51										
A. 158		V-1840	2000 mm	1 pc	AN	121,30/pc	IXE	145,30/pc		
			3000 mm	1 pc	AN	160,30/pc	IXE	195,30/pc		
			4000 mm	1 pc	AN	201,50/pc	IXE	246,70/pc		
		6000 mm	1 pc	AN	295,50/pc	IXE	364,00/pc			
		V-1840 MIS	1500 → 3000 mm	1 pc	AN	277,00/pc	IXE	409,30/pc		
		3000 → 6000 mm	1 pc	AN	294,00/pc	IXE	483,70/pc			
		IV-1840-BINARIO	6000 mm	■ 2 pcs	AN	203,30/pc 33,88/m				
		IV-1840-VELETTA	6000 mm	■ 8 pcs	AN	84,00/pc 14,00/m	IXE	150,70/pc 25,12/m		
<ul style="list-style-type: none"> • VeleTTa vendibile solo con binario di pari lunghezza, se acquistata sciolta va calcolata una maggiorazione di € 30,00 per ogni imballo. • Cover profile available only packed with rail profile. For profiles supplied without rails the extra cost for each package unit is € 30,00. • Profilabdeckung lieferbar nur mit Laufschiene verpackt. Aufpreis für Profilabdeckungen ohne Laufschiene ist € 30,00 pro Verpackungseinheit 										
		TAGLIO-SCORR-UNI Costo per un taglio con misure uguali Cost for cut with same size Preis für einen Schnitt mit gleichen Maß				38,70/pc				
MINIMO D'ORDINE: 2 profili da 6 mt (o multipli) MINIMUM ORDER: No. 2 - 6 m profiles (or multiples) MINDESTBESTELLMENGE: 2 Profile mit 6 m (nur als Vielfaches)										
A. 159		V-1842		1 set		100,00/set				
		V-1842		■ min 5 set		85,50/set				
A. 160		V-1846-50		1 set		55,30/set				
		V-1846-50		■ min 5 set		50,00 / set				

- Confezioni industriali
- Industrial packaging
- Industrieverpackungen

- FIX**
- Lunghezza fissa
 - Fixed length
 - Feste Länge

- MIS**
- Tagliato dal cliente
 - Cut by installer
 - Schnitt bauseitig

- MIS**
- Tagliato a misura del cliente
 - Custom length
 - Nach Mass geschnitten

-
- Confezioni profili con quantità fissa, disponibili solo in multipli della quantità indicata.
 - Packs of profiles with fixed quantity, available only in multiples of the indicated quantity.
 - Profilpackungen mit fixer Menge sind nur als Vielfaches der angeführten Menge erhältlich.

-
- Trasporto fuori standard. Vedi condizioni di vendita
 - Non-standard transport. See sales conditions
 - Sondertransport. Siehe AGB

POS.	PROD.	ART.	MIS.	Q.TÀ	FIN.	EURO	FIN.	EURO	FIN.	EURO
A. 161		V-1841		2 pc	AN	11,00/set	IXE	14,30/set		
		V-1841		■ min 5 set	AN	8,00/pc	IXE	11,30/pc		
A. 162		V-012		1 pc	AN	18,30/pc	NS	21,70/pc	CR	21,70/pc
		V-012		■ min 5 pcs	AN	12,50/pc	NS	15,70/pc	CR	15,70/pc
A. 163	 50 Kg x 2 pc	V-1845		1 pc		43,00/pc				
		V-1845		■ min 10 pcs		34,70/pc				
		V-1845		■ min 20 pcs		29,00/pc				
A. 164		V-1848		1 pc		30,30/pc				
		V-1848		■ min 10 pcs		22,30/pc				
A. 165		V-1847		2 pc		26,00/set				
		V-1847		■ min 10 set		18,30/pc				

BRIXIA 140 (OPTIONAL SOFT-CLOSE)

		V-1890	▲ SLIDING 60								
A. 166		V-1890 SET 1 FIX	2000 mm	1 set	AN	574,70/set					
			3000 mm	1 set	AN	691,50/set					
			4000 mm	1 set	AN	832,00/set					
			V-1890 SET 1 MIS	1500 → 3000 mm	1 set	AN	776,00/set				
A. 167		V-1890 SET 2 FIX	3000 mm	1 set	AN	796,50/set					
			4000 mm	1 set	AN	913,30/set					
			6000 mm	1 set	AN	1053,00/set					
			V-1890 SET 2 MIS	1500 → 3000 mm	1 set	AN	999,30/set				
			3000 → 6000 mm	1 set	AN	1420,00/set					

CF

- Prezzi speciali per l'acquisto delle quantità minime indicate (CF) dell'articolo. NB eventuali riordini o aggiunte per completamenti se di quantità inferiore alla minima, saranno fatturati al prezzo normale
- Special prices for the purchase of the minimum quantities indicated (CF) of the article. Note Well: any reorders or additions for completions of quantity less than the minimum will be invoiced at the normal price.
- Artikel mit Sonderpreisen bei Mindestabnahmemengen sind mit (CF) gekennzeichnet. Nachbestellungen oder Ergänzungen unter der Mindestabnahmemenge werden mit dem Normalpreis verrechnet.

POS.	PROD.	ART.	MIS.	Q.TÀ	FIN.	EURO	FIN.	EURO	FIN.	EURO
▲ SLIDING 61										
	V-1893									
A. 168		V-1893 SET 1 FIX	2000 mm	1 set	AN	744,70/set				
			3000 mm	1 set	AN	924,70/set				
			4000 mm	1 set	AN	1117,30/set				
			1500 → 3000 mm	1 set	AN	995,70/set				
			3000 → 6000 mm	1 set	AN	1611,00/set				
A. 169		V-1893 SET 2 FIX	2000 mm	1 set	AN	966,00/set				
			3000 mm	1 set	AN	1143,00/set				
			4000 mm	1 set	AN	1337,50/set				
			6000 mm	1 set	AN	1387,30/set				
			V-1893 SET 2 MIS	1500 → 3000 mm	1 set	AN	1285,30/set			
			3000 → 6000 mm	1 set	AN	1851,30/set				
▲ SLIDING 62/63										
V-1890 / V-1893 COMPONENTI / COMPONENTS / EINZELTEILE										
A. 170		V-1890	2000 mm	1 pc	AN	242,00/pc				
			3000 mm	1 pc	AN	334,50/pc				
			4000 mm	1 pc	AN	448,70/pc				
			6000 mm	1 pc	AN	606,50/pc				
			V-1890 MIS	1500 → 3000 mm	1 pc	AN	415,30/pc			
			3000 → 6000 mm	1 pc	AN	758,00/pc				
A. 171		V-1632H	2000 mm	1 pc	AN	109,50/pc				
			3000 mm	1 pc	AN	138,30/pc				
			4000 mm	1 pc	AN	189,30/pc				
			6000 mm	1 pc	AN	221,70/pc				
			V-1632H MIS	1500 → 3000 mm	1 pc	AN	211,30/pc			
			3000 → 6000 mm	1 pc	AN	358,00/pc				
<ul style="list-style-type: none"> • Veletta vendibile solo con binario di pari lunghezza, se acquistata sciolta va calcolata una maggiorazione di € 30,00 per ogni imballo. • Cover profile available only packed with rail profile. For profiles supplied without rails the extra cost for each package unit is € 30,00, • Profilabdeckung lieferbar nur mit Laufschiene verpackt. Aufpreis für Profilabdeckungen ohne Laufschienen ist € 30,00 pro Verpackungseinheit 										
A. 172		V-1894	2000 mm	1 pc	AN	186,30/pc				
			3000 mm	1 pc	AN	250,00/pc				
			4000 mm	1 pc	AN	337,30/pc				
			6000 mm	1 pc	AN	439,30/pc				
			V-1894 MIS	1500 → 3000 mm	1 pc	AN	328,00/pc			
			3000 → 6000 mm	1 pc	AN	584,50/pc				
A. 173		V-1892		1 set		215,00/set				

FIX

- Lunghezza fissa
- Fixed length
- Feste Länge



- Tagliato dal cliente
- Cut by installer
- Schnitt bauseitig

MIS

- Tagliato a misura del cliente
- Custom length
- Nach Mass geschnitten



- Trasporto fuori standard. Vedi condizioni di vendita
- Non-standard trasport. See sales conditions
- Sondertransport. Siehe AGB

POS.	PROD.	ART.	MIS.	Q.TÀ	FIN.	EURO	FIN.	EURO	FIN.	EURO
A. 174	OPTIONAL soft-close 100 Kg	V-1824-100		1 pc		197,00 /pc				
A. 175	OPTIONAL soft-close 140 Kg	V-1824-140		1 pc		197,00 /pc				
A. 176	 100 Kg	V-1896-100		1 set		373,30 /set				
A. 177	 140 Kg	V-1896-140		1 set		373,30 /set				
A. 178		V-090		1 pc		59,00 /pc				
A. 179	 A 63,50 B 63,50 C 63,50	V-1817-A / V-1817-B / V-1817-C			1 set	A 33,50 /set	B 33,50 /set	C 33,50 /set		
		V-1817-A / V-1817-B / V-1817-C			■ min 5 set	A 27,00 /set	B 27,00 /set	C 27,00 /set		
A. 180		V-1895		1 pc		72,50 /pc				
A. 181		V-1891		2 pc		52,30 /set				
A. 182		V-012		1 pc	AN	18,30 /pc	NS	21,70 /pc	CR	21,70 /pc
		V-012		■ min 5 pcs	AN	12,50 /pc	NS	15,70 /pc	CR	15,70 /pc
A. 183		V-012-EVO		1 pc	AN	23,70 /pc	NS	28,30 /pc	NO	28,30 /pc
		V-012-EVO		■ min 5 pcs	AN	19,00 /pc	NS	22,30 /pc	NO	22,30 /pc

POS.	PROD.	ART.	MIS.	Q.TÀ	FIN.	EURO	FIN.	EURO	FIN.	EURO	
A. 184		V-1898		2 pc		33,00/set					
A. 185		V-1899		2 pc	AN	36,50/set					
A. 186		V-1897	1 pc x LB 400 mm	1 pc		33,00/pc					
A. 187		VP-019-MT	1000 mm	1 pc		7,30/pc					
			2000 mm	1 pc		5,30/pc					
			3000 mm	1 pc		4,70/pc					
		VP-018-MT	1000 mm	1 pc		7,30/pc					
			2000 mm	1 pc		5,30/pc					
			3000 mm	1 pc		4,70/pc					

SESAMO







V-2000 ▲ SLIDING 64											
A. 188		V-2000 SET 1 FIX	2000 mm	1 set	AN	913,30/set					
			3000 mm	1 set	AN	1065,00/set					
			4000 mm	1 set	AN	1234,00/set					
			V-2000 SET 1 MIS	1500 → 3000 mm	1 set	AN	1160,50/set				
A. 189		V-2000 SET 3 FIX	3000 mm	1 set	AN	980,00/set					
			4000 mm	1 set	AN	1149,50/set					
			6000 mm	1 set	AN	1432,00/set					
			V-2000 SET 3 MIS	1500 → 3000 mm	1 set	AN	1086,50/set				
			3000 → 6000 mm	1 set	AN	1643,50/set					
V-2000 COMPONENTI / COMPONENTS / EINZELTEILE ▲ SLIDING 65											
A. 190		V-2000	2000 mm	1 pc	AN	431,00/pc					
			3000 mm	1 pc	AN	592,00/pc					
			4000 mm	1 pc	AN	801,00/pc					
			6000 mm	1 pc	AN	1110,50/pc					
			V-2000 MIS	1500 → 3000 mm	1 pc	AN	655,30/pc				
			3000 → 6000 mm	1 pc	AN	1188,00/pc					

FIX
 • Lunghezza fissa
 • Fixed length
 • Feste Länge

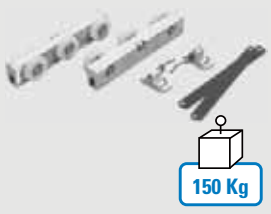
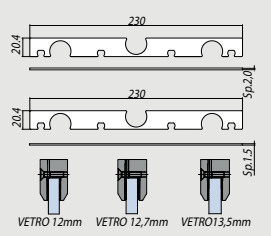
MIS
 • Tagliato dal cliente
 • Cut by installer
 • Schnitt bauseitig

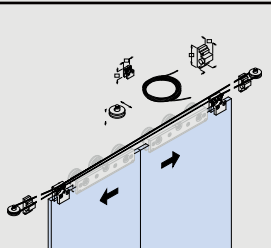
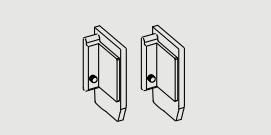
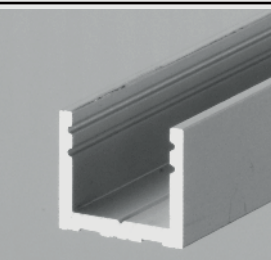
MIS
 • Tagliato a misura del cliente
 • Custom length
 • Nach Mass geschnitten

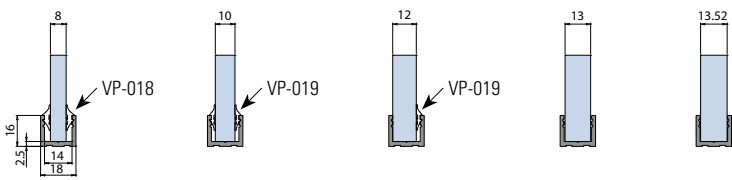
Trasporto fuori standard
 • Trasporto fuori standard. Vedi condizioni di vendita
 • Non-standard trasport. See sales conditions
 • Sondertransport. Siehe AGB

POS.	PROD.	ART.	MIS.	Q.TÀ	FIN.	EURO	FIN.	EURO	FIN.	EURO	
A. 191	 150 Kg	V-2002		1 set		446,00/set					
A. 192	 VETRO 12mm VETRO 12,7mm VETRO13,5mm	V-2007		1 set		52,00/set					
A. 193		V-012		1 pc	AN	18,30/pc	NS	21,70/pc	CR	21,70/pc	
A. 194		V-2010		1 set		412,50/set					
A. 195		V-2001		2 pc	AN	71,50/set					
A. 196		V-2014-MIX		2000 mm	1 pc	AN	34,30/pc	IXE	47,30/pc	NO	44,30/pc
				3000 mm	1 pc	AN	41,70/pc	IXE	62,30/pc	NO	54,30/pc
				6000 mm	1 pc	AN	62,30/pc	IXE	103,50/pc	NO	81,00/pc
			MIX	<ul style="list-style-type: none"> • Minimo ordine 5 pezzi, anche assortiti, fra i vari profili e guarnizioni • Minimum order 5 pc also for combinations of various profiles and gaskets • Mindestbestellmenge 5 Stück, auch sortiert nach verschiedenen Profilen und Dichtungen 							
											
		VP-018	3 mm	20 mt		38,50					
		VP-019	2 mm	20 mt		38,50					

POS.	PROD.	ART.	MIS.	Q.TÀ	FIN.	EURO	FIN.	EURO	FIN.	EURO
A. 197		 VP-019-MT	1000 mm	1 pc		7,30/pc				
			2000 mm	1 pc		5,30/pc				
			3000 mm	1 pc		4,70/pc				
		 VP-018-MT	1000 mm	1 pc		7,30/pc				
			2000 mm	1 pc		5,30/pc				
			3000 mm	1 pc		4,70/pc				
INVISIBILE (OPTIONAL SOFT-CLOSE)										
V-7100  ▲ SLIDING 80										
A. 198		V-7100 SET 1 FIX	2000 mm	1 set	AN	660,00/set				
			3000 mm	1 set	AN	797,50/set				
			4000 mm	1 set	AN	935,00/set				
			1500 → 3000 mm	1 set	AN	893,30/set				
			3000 → 6000 mm	1 set	AN	1263,00/set				
A. 199		V-7100 SET 2 FIX	3000 mm	1 set	AN	1103,00/set				
			4000 mm	1 set	AN	1240,70/set				
			 6000 mm	1 set	AN	1538,30/set				
			1500 → 3000 mm	1 set	AN	1191,00/set				
			3000 → 6000 mm	1 set	AN	1660,70/set				
V-7103  ▲ SLIDING 81										
A. 200		V-7103 SET 1 FIX	2000 mm	1 set	AN	820,00/set				
			3000 mm	1 set	AN	1017,00/set				
			4000 mm	1 set	AN	1210,00/set				
			1500 → 3000 mm	1 set	AN	1139,00/set				
			3000 → 6000 mm	1 set	AN	1818,70/set				
A. 201		V-7103 SET 2 FIX	3000 mm	1 set	AN	1322,30/set				
			4000 mm	1 set	AN	1515,30/set				
			 6000 mm	1 set	AN	1929,30/set				
			1500 → 3000 mm	1 set	AN	1428,00/set				
			3000 → 6000 mm	1 set	AN	2083,70/set				
V-7100 ▲ SLIDING 82 COMPONENTI / COMPONENTS / EINZELTEILE										
A. 202		V-7101	2000 mm	1 pc	AN	354,30/pc				
			3000 mm	1 pc	AN	492,30/pc				
			4000 mm	1 pc	AN	630,00/pc				
			 6000 mm	1 pc	AN	927,30/pc				
			1500 → 3000 mm	1 pc	AN	551,30/pc				
			3000 → 6000 mm	1 pc	AN	1038,50/pc				
		V-7101 MIS 								

FIX

- Lunghezza fissa
- Fixed length
- Feste Länge



- Tagliato dal cliente
- Cut by installer
- Schnitt bauseitig

MIS

- Tagliato a misura del cliente
- Custom length
- Nach Mass geschnitten



- Trasporto fuori standard. Vedi condizioni di vendita
- Non-standard transport. See sales conditions
- Sondertransport. Siehe AGB

POS.	PROD.	ART.	MIS.	Q.TÀ	FIN.	EURO	FIN.	EURO	FIN.	EURO	
A. 203		V-7104	2000 mm	1 pc	AN	164,70 /pc					
			3000 mm	1 pc	AN	220,00 /pc					
			4000 mm	1 pc	AN	275,00 /pc					
			6000 mm	1 pc	AN	392,00 /pc					
			V-7104 MIS	1500 → 3000 mm	1 pc	AN	246,30 /pc				
			3000 → 6000 mm	1 pc	AN	438,70 /pc					
A. 204		V-7006-CF2	2000 mm	2 pc	AN	128,00 /2 pc					
			3000 mm	2 pc	AN	176,70 /2 pc					
			4000 mm	2 pc	AN	225,30 /2 pc					
			6000 mm	2 pc	AN	329,00 /2 pc					
<ul style="list-style-type: none"> • Veletta vendibile solo con binario di pari lunghezza, se acquistata sciolta va calcolata una maggiorazione di € 30,00 per ogni imballo. • Cover profile available only packed with rail profile. For profiles supplied without rails the extra cost for each package unit is € 30,00. • Profilabdeckung lieferbar nur mit Laufschiene verpackt. Aufpreis für Profilabdeckungen ohne Laufschienen ist € 30,00 pro Verpackungseinheit 											
A. 205		V-7102		1 set		275,30 /set					
A. 206		V-7107		1 set		85,70 /set					
A. 207		V-7108		1 set		222,30 /set					
	OPTIONAL 										
A. 208		V-7105	1 pc x LB 400 mm	1 pc	AN	27,70 /pc					
A. 209		V-012-INS		1 pc	AN	32,50 /pc	NS	35,00 /pc	CR	37,50 /pc	
		V-012-INS		min 5 pcs	AN	26,00 /pc	NS	28,00 /pc	CR	30,00 /pc	

CF

- Prezzi speciali per l'acquisto delle quantità minime indicate (CF) dell'articolo. NB eventuali riordini o aggiunte per completamenti se di quantità inferiore alla minima, saranno fatturati al prezzo normale
- Special prices for the purchase of the minimum quantities indicated (CF) of the article. Note Well: any reorders or additions for completions of quantity less than the minimum will be invoiced at the normal price.
- Artikel mit Sonderpreisen bei Mindestabnahmemengen sind mit (CF) gekennzeichnet. Nachbestellungen oder Ergänzungen unter der Mindestabnahmemenge werden mit dem Normalpreis verrechnet.

POS.	PROD.	ART.	MIS.	Q.TÀ	FIN.	EURO	FIN.	EURO	FIN.	EURO
A. 210		 VP-019-MT	1000 mm	1 pc		7,30/pc				
			2000 mm	1 pc		5,30/pc				
			3000 mm	1 pc		4,70/pc				
		 VP-018-MT	1000 mm	1 pc		7,30/pc				
			2000 mm	1 pc		5,30/pc				
			3000 mm	1 pc		4,70/pc				

INVISIBLE EVOLUTION (OPTIONAL SOFT-CLOSE)

V-7150		70 Kg		▲ SLIDING 74/75						
A. 211		V-7150 SET 1 FIX	2000 mm	1 set	AN	368,30/set				
			3000 mm	1 set	AN	460,70/set				
			4000 mm	1 set	AN	578,30/set				
			1500 → 3000 mm	1 set	AN	491,30/set				
			3000 → 6000 mm	1 set	AN	754,00/set				
A. 212		V-7150 SET 2 FIX	3000 mm	1 set	AN	604,30/set				
			4000 mm	1 set	AN	722,00/set				
			6000 mm	1 set	AN	866,70/set				
			1500 → 3000 mm	1 set	AN	635,30/set				
			3000 → 6000 mm	1 set	AN	898,00/set				
A. 213		V-7160 SET 1 FIX	2000 mm	1 set	AN	440,30/set				
			3000 mm	1 set	AN	532,50/set				
			4000 mm	1 set	AN	650,30/set				
			1500 → 3000 mm	1 set	AN	563,70/set				
			3000 → 6000 mm	1 set	AN	826,00/set				
A. 214		V-7160 SET 2 FIX	3000 mm	1 set	AN	747,70/set				
			4000 mm	1 set	AN	865,50/set				
			6000 mm	1 set	AN	1010,30/set				
			1500 → 3000 mm	1 set	AN	779,00/set				
			3000 → 6000 mm	1 set	AN	1041,30/set				
A. 215		V-7153 SET 1 FIX	2000 mm	1 set	AN	414,30/set				
			3000 mm	1 set	AN	527,30/set				
			4000 mm	1 set	AN	668,00/set				
			1500 → 3000 mm	1 set	AN	558,30/set				
			3000 → 6000 mm	1 set	AN	877,00/set				

- Confezioni industriali
 - Industrial packaging
 - Industrieverpackungen
- FIX**
- Lunghezza fissa
 - Fixed length
 - Feste Länge

- MIS**
- Tagliato dal cliente
 - Cut by installer
 - Schnitt bauseitig

- MIS**
- Tagliato a misura del cliente
 - Custom length
 - Nach Mass geschnitten

- !**
- Confezioni profili con quantità fissa, disponibili solo in multipli della quantità indicata.
 - Packs of profiles with fixed quantity, available only in multiples of the indicated quantity.
 - Profilpackungen mit fixer Menge sind nur als Vielfaches der angeführten Menge erhältlich.

- !**
- Trasporto fuori standard. Vedi condizioni di vendita
 - Non-standard transport. See sales conditions
 - Sondertransport. Siehe AGB

POS.	PROD.	ART.	MIS.	Q.TÀ	FIN.	EURO	FIN.	EURO	FIN.	EURO
A. 216		V-7153 SET 2 FIX V-7153 SET 2 MIS	3000 mm	1 set	AN	670,70/set				
			4000 mm	1 set	AN	811,50/set				
			6000 mm	1 set	AN	989,30/set				
			1500 → 3000 mm	1 set	AN	702,30/set				
			3000 → 6000 mm	1 set	AN	1022,70/set				
V-7163			▲ SLIDING 76/77							
A. 217		V-7163 SET 1 FIX V-7163 SET 1 MIS	2000 mm	1 set	AN	486,00/set				
			3000 mm	1 set	AN	599,00/set				
			4000 mm	1 set	AN	740,00/set				
			1500 → 3000 mm	1 set	AN	630,00/set				
			3000 → 6000 mm	1 set	AN	951,30/set				
A. 218		V-7163 SET 2 FIX V-7163 SET 2 MIS	3000 mm	1 set	AN	814,50/set				
			4000 mm	1 set	AN	955,30/set				
			6000 mm	1 set	AN	1133,00/set				
			1500 → 3000 mm	1 set	AN	845,50/set				
			3000 → 6000 mm	1 set	AN	1164,00/set				
V-7150 / V-7160 / V-7153 / V-7163		▲ 78/7914/15								
COMPONENTI / COMPONENTS / EINZELTEILE										
219		V-7150 V-7150 MIS	2000 mm	1 pc	AN	224,50/pc				
			3000 mm	1 pc	AN	317,00/pc				
			4000 mm	1 pc	AN	434,70/pc				
			6000 mm	1 pc	AN	579,30/pc				
			1500 → 3000 mm	1 pc	AN	348,00/pc				
3000 → 6000 mm	1 pc	AN	610,70/pc							
		IV-7150-CF	2000 mm	■ min 6 pc	AN	183,50/pc				
			3000 mm	■ min 4 pc	AN	268,50/pc				
A. 220		V-7153 V-7153 MIS	2000 mm	1 pc	AN	270,30/pc				
			3000 mm	1 pc	AN	384,00/pc				
			4000 mm	1 pc	AN	524,50/pc				
			6000 mm	1 pc	AN	702,30/pc				
			1500 → 3000 mm	1 pc	AN	415,00/pc				
3000 → 6000 mm	1 pc	AN	733,30/pc							
		IV-7153-CF	2000 mm	■ min 6 pcs	AN	225,50/pc				
			3000 mm	■ min 4 pcs	AN	337,00/pc				

CF

- Prezzi speciali per l'acquisto delle quantità minime indicate (CF) dell'articolo. NB eventuali riordini o aggiunte per completamenti se di quantità inferiore alla minima, saranno fatturati al prezzo normale
- Special prices for the purchase of the minimum quantities indicated (CF) of the article. Note Well: any reorders or additions for completions of quantity less than the minimum will be invoiced at the normal price.
- Artikel mit Sonderpreisen bei Mindestabnahmemengen sind mit (CF) gekennzeichnet. Nachbestellungen oder Ergänzungen unter der Mindestabnahmemenge werden mit dem Normalpreis verrechnet.

POS.	PROD.	ART.	MIS.	Q.TÀ	FIN.	EURO	FIN.	EURO	FIN.	EURO
		IV-7150 ⚠	6000 mm	■ 2 pcs	AN	397,00 /pc 66,17 /m				
		IV-7153-BIN-FIX ⚠	6000 mm	■ 2 pcs	AN	556,50 /pc 92,75 /m				
		IV-7151-VELETTA ⚠	6000 mm	■ 2 pcs	AN	100,30 /pc 16,72 /m				
		IV-7150-CLIPS	(2 pc / m)	■ min 12 pcs		1,50 /pc				
		TAGLIO-SCORR-UNI Costo per un taglio con misure uguali Cost for cut with same size Preis für einen Schnitt mit gleichen Maß				38,70 /pc				
		MINIMO D'ORDINE: 2 profili da 6 mt (o multipli ⚠) MINIMUM ORDER: No. 2 - 6 m profiles (or multiples ⚠) MINDESTBESTELLMENGE: 2 Profile mit 6 m (nur als Vielfaches ⚠)								
A. 221		V-5102		1 set		183,50 /set				
		V-5102		■ min 5 set		170,50 /set				
A. 222		V-5152		1 set		111,30 /set				
		V-5152		■ min 5 set		93,70 /set				
A. 223		V-5406		1 set		121,30 /set				
		V-5406		■ min 5 set		114,00 /set				
A. 224		V-5046-70 C		1 set		91,70 /set				
		V-5046-70 C		■ min 5 set		67,00 /set				
A. 225		V-5406-120		1 set		247,30 /set				
		V-5406-120		■ min 5 set		232,70 /set				

FIX
 • Confezioni industriali
 • Industrial packaging
 • Industrieverpackungen
 • Lunghezza fissa
 • Fixed length
 • Feste Länge

MIS
 • Tagliato dal cliente
 • Cut by installer
 • Schnitt baueitig
 • Tagliato a misura del cliente
 • Custom length
 • Nach Mass geschnitten

⚠
 • Confezioni profili con quantità fissa, disponibili solo in multipli della quantità indicata.
 • Packs of profiles with fixed quantity, available only in multiples of the indicated quantity.
 • Profilpackungen mit fixer Menge sind nur als Vielfaches der angeführten Menge erhältlich.

• Trasporto fuori standard. Vedi condizioni di vendita
 • Non-standard transport. See sales conditions
 • Sondertransport. Siehe AGB

POS.	PROD.	ART.	MIS.	Q.TÀ	FIN.	EURO	FIN.	EURO	FIN.	EURO	
A. 226		V-5107 Per / For / Für V-5102		1 set		52,00/set					
						■ min 5 set	41,30/set				
A. 227		V-012-INS		1 pc	AN	32,50/pc	NS	35,00/pc	CR	37,50/pc	
		V-012-INS		■ min 5 pcs	AN	26,00/pc	NS	28,00/pc	CR	30,00/pc	
A. 228			OPTIONAL		1000 mm	1 pc	7,30/pc				
			VP-019-MT		2000 mm	1 pc	5,30/pc				
					3000 mm	1 pc	4,70/pc				
			VP-018-MT		1000 mm	1 pc	7,30/pc				
					2000 mm	1 pc	5,30/pc				
					3000 mm	1 pc	4,70/pc				

BRIXIA INVISIBILE										
V-1815 ▲ SLIDING 86										
A. 229	<p>Maniglia non inclusa Handle not included Griff nicht enthalten</p>	V-1815 SET 1 FIX		2000 mm	1 set	AN	859,50/set			
				3000 mm	1 set	AN	921,00/set			
				4000 mm	1 set	AN	986,70/set			
		V-1815 SET 1 MIS		1500 → 3000 mm	1 set	AN	985,30/set			
A. 230	<p>Maniglia non inclusa Handle not included Griff nicht enthalten</p>	V-1815 SET 2 FIX		3000 mm	1 set	AN	1589,50/set			
				4000 mm	1 set	AN	1651,00/set			
				6000 mm	1 set	AN	1716,50/set			
		V-1815 SET 2 MIS		1500 → 3000 mm	1 set	AN	1716,50/set			
A. 231	<p>Maniglia non inclusa Handle not included Griff nicht enthalten</p>	V-1815 SET 5 FIX		2000 mm	1 set	AN	1729,50/set			
				3000 mm	1 set	AN	1837,30/set			
				4000 mm	1 set	AN	1943,30/set			
		V-1815 SET 5 MIS		1500 → 3000 mm	1 set	AN	1942,00/set			
		3000 → 6000 mm	1 set	AN	2264,50/set					

POS.	PROD.	ART.	MIS.	Q.TÀ	FIN.	EURO	FIN.	EURO	FIN.	EURO
<p>V-1815-F ▲ SLIDING 86</p>										
A. 232	<p>Maniglia non inclusa Handle not included Griff nicht enthalten</p>	V-1815-F SET 1 FIX	2000 mm	1 set	AN	967,30/set				
			3000 mm	1 set	AN	1027,30/set				
			4000 mm	1 set	AN	1094,30/set				
			1500 → 3000 mm	1 set	AN	1093,30/set				
			3000 → 6000 mm	1 set	AN	1315,00/set				
A. 233	<p>Maniglia non inclusa Handle not included Griff nicht enthalten</p>	V-1815-F SET 2 FIX	3000 mm	1 set	AN	1697,50/set				
			4000 mm	1 set	AN	1758,70/set				
			6000 mm	1 set	AN	1824,70/set				
			1500 → 3000 mm	1 set	AN	1822,70/set				
			3000 → 6000 mm	1 set	AN	2045,30/set				
A. 234	<p>Maniglia non inclusa Handle not included Griff nicht enthalten</p>	V-1815-F SET 5 FIX	2000 mm	1 set	AN	1905,30/set				
			3000 mm	1 set	AN	2013,00/set				
			4000 mm	1 set	AN	2119,30/set				
			1500 → 3000 mm	1 set	AN	2118,30/set				
			3000 → 6000 mm	1 set	AN	2372,30/set				
<p>V-1815 / V-1815-F ▲ SLIDING 87 COMPONENTI / COMPONENTS / EINZELTEILE</p>										
A. 235		V-1860	2000 mm	1 pc	AN	117,00/pc				
			3000 mm	1 pc	AN	160,50/pc				
			4000 mm	1 pc	AN	204,30/pc				
			6000 mm	1 pc	AN	288,70/pc				
			1500 → 3000 mm	1 pc	AN	186,30/pc				
A. 236		IV-1860	3000 mm	■ 4 pcs	AN	120,50/pc 40,17/m				
			6000 mm	■ 2 pcs	AN	236,30/pc 39,38/m				
TAGLIO-SCORR-UNI Costo per un taglio con misure uguali Cost for cut with same size Preis für einen Schnitt mit gleichen Maß						38,70/pc				
<p>MINIMO D'ORDINE: 2 profili da 6 mt o 4 profili da 3 mt. (o multipli ▲), anche assortiti tra i vari modelli MINIMUM ORDER: No. 2 - 6 m profiles, or No. 4 - 3 m profiles, (or multiples ▲), also in combination of different models. MINDESTBESTELLMENGE: 2 Profile mit 6 m oder 4 Profile mit 3 m (nur als Vielfaches ▲), auch sortiert nach den verschiedenen Modellen.</p>										
A. 236		V-1815	2000 mm	1 pc	AN	203,70/pc				
			3000 mm	1 pc	AN	244,50/pc				
			4000 mm	1 pc	AN	288,50/pc				
			6000 mm	1 pc	AN	381,70/pc				
			1500 → 3000 mm	1 pc	AN	322,00/pc				
		V-1815 MIS	3000 → 6000 mm	1 pc	AN	475,50/pc				

- FIX**
- Confezioni industriali
 - Industrial packaging
 - Industrieverpackungen
 - Lunghezza fissa
 - Fixed length
 - Feste Länge

- MIS**
- Tagliato dal cliente
 - Cut by installer
 - Schnitt bauseitig

- MIS**
- Tagliato a misura del cliente
 - Custom length
 - Nach Mass geschnitten

-
- Confezioni profili con quantità fissa, disponibili solo in multipli della quantità indicata.
 - Packs of profiles with fixed quantity, available only in multiples of the indicated quantity.
 - Profilpackungen mit fixer Menge sind nur als Vielfaches der angeführten Menge erhältlich.

-
- Trasporto fuori standard. Vedi condizioni di vendita
 - Non-standard transport. See sales conditions
 - Sondertransport. Siehe AGB

POS.	PROD.	ART.	MIS.	Q.TÀ	FIN.	EURO	FIN.	EURO	FIN.	EURO
A. 237	<p>LM L Profilo HM altezza mobile 1050</p> <p>P-203 P-202 F-007 Maniglia da ordinare a parte Handle to order separately Schiebegriffe nicht inkl. P-205</p>	PO-290-BRIXIA	max LM 1200 mm x HM 3000 mm	1 set	AN	636,50/set	NO*	763,70/set		
A. 238		F-007		1 pair	AN	86,30/pair	NO*	102,50/pair		
		F-007		■ min 5 pairs	AN	61,00/pair	NO*	72,50/pair		
A. 239	<p>soft-close 70 Kg OPTIONAL</p>	V-1824-70 M		1 pc	AN	102,30/pc				
A. 240	<p>soft-close 50 Kg OPTIONAL</p>	V-1824-50 M		1 pc	AN	102,30/pc				
A. 241	<p>Tappo Cap Kappe</p>	V-1815-TA		1 pc	AN	35,30/pc				
A. 242		P-202 MIS		1 pc	AN	81,70/m	NO*	94,30/m		
A. 243		P-203 MIS		1 pc	AN	90,00/m	NO*	108,00/m		
A. 244		P-205 MIS		1 pc	AN	75,70/m	NO*	87,00/m		

CF

- Prezzi speciali per l'acquisto delle quantità minime indicate (CF) dell'articolo. NB eventuali riordini o aggiunte per completamenti se di quantità inferiore alla minima, saranno fatturati al prezzo normale
- Special prices for the purchase of the minimum quantities indicated (CF) of the article. Note Well: any reorders or additions for completions of quantity less than the minimum will be invoiced at the normal price.
- Artikel mit Sonderpreisen bei Mindestabnahmemengen sind mit (CF) gekennzeichnet. Nachbestellungen oder Ergänzungen unter der Mindestabnahmemenge werden mit dem Normalpreis verrechnet.

NO* Nero opaco - Matt black - Schwarz matt

- Disponibilità da verificare con ufficio commerciale
- Availability to be checked with sales office
- Die Verfügbarkeit ist mit dem Verkaufsbüro abzustimmen

POS.	PROD.	ART.	MIS.	Q.TÀ	FIN.	EURO	FIN.	EURO	FIN.	EURO	
A. 245		P-202 B	6000 mm	1 pc	AN	411,00 /pc 68,50 /m	NO*	492,00 /pc 82,00 /m			
		SECTOR 4P	IP-202	3000 mm	■ 4 pcs	AN	147,30 /pc 49,10 /m	NO*	176,00 /pc 58,67 /m		
				6000 mm	■ 2 pcs	AN	286,70 /pc 47,78 /m	NO*	344,00 /pc 57,33 /m		
			MINIMO D'ORDINE: 2 profili da 6 mt o 4 profili da 3 mt. (o multipli), anche assortiti tra i vari modelli MINIMUM ORDER: No. 2 - 6 m profiles, or No. 4 - 3 m profiles, (or multiples), also in combination of different models. MINDESTBESTELLMENGE: 2 Profile mit 6 m oder 4 Profile mit 3 m (nur als Vielfaches), auch sortiert nach den verschiedenen Modellen.								
A. 246		P-203 B	6000 mm	1 pc	AN	480,00 /pc 80,00 /m	NO*	687,00 /pc 114,50 /m			
		SECTOR 4P	IP-203	3000 mm	■ 4 pcs	AN	117,50 /pc 39,17 /m	NO*	141,00 /pc 47,00 /m		
				6000 mm	■ 2 pcs	AN	227,30 /pc 37,88 /m	NO*	277,30 /pc 46,22 /m		
		SECTOR 4P	IP-203-VELETTA	3000 mm	■ 4 pcs	AN	52,00 /pc 17,33 /m	NO*	67,70 /pc 22,57 /m		
				6000 mm	■ 2 pcs	AN	90,00 /pc 15,00 /m	NO*	116,70 /pc 19,45 /m		
		<ul style="list-style-type: none"> • Veletta vendibile solo con binario di pari lunghezza, se acquistata sciolta va calcolata una maggiorazione di € 30,00 per ogni imballo. • Cover profile available only packed with rail profile. For profiles supplied without rails the extra cost for each package unit is € 30,00. • Profilabdeckung lieferbar nur mit Laufschiene verpackt. Aufpreis für Profilabdeckungen ohne Laufschienen ist € 30,00 pro Verpackungseinheit MINIMO D'ORDINE: 2 profili da 6 mt o 4 profili da 3 mt. (o multipli), anche assortiti tra i vari modelli MINIMUM ORDER: No. 2 - 6 m profiles, or No. 4 - 3 m profiles, (or multiples), also in combination of different models. MINDESTBESTELLMENGE: 2 Profile mit 6 m oder 4 Profile mit 3 m (nur als Vielfaches), auch sortiert nach den verschiedenen Modellen.									
A. 247		P-205 B	6000 mm	1 pc	AN	385,80 /pc 64,30 /m	NO*	462,00 /pc 77,00 /m			
		SECTOR 4P	IP-205	3000 mm	■ 4 pcs	AN	122,00 /pc 40,67 /m	NO*	146,70 /pc 48,90 /m		
				6000 mm	■ 2 pcs	AN	236,50 /pc 39,42 /m	NO*	284,30 /pc 47,38 /m		
			MINIMO D'ORDINE: 2 profili da 6 mt o 4 profili da 3 mt. (o multipli), anche assortiti tra i vari modelli MINIMUM ORDER: No. 2 - 6 m profiles, or No. 4 - 3 m profiles, (or multiples), also in combination of different models. MINDESTBESTELLMENGE: 2 Profile mit 6 m oder 4 Profile mit 3 m (nur als Vielfaches), auch sortiert nach den verschiedenen Modellen.								
A. 248											
A. 249		PO-292-BRIXIA		1 set	AN	160,00 /set					
		PO-292-BRIXIA		■ min 5 set	AN	130,00 /set					

- Confezioni industriali
Industrial packaging
Industrieverpackungen
- FIX**
- Lunghezza fissa
 - Fixed length
 - Feste Länge

- ✂** Tagliato dal cliente
Cut by installer
Schnitt bauseitig

- MIS**
- Tagliato a misura del cliente
 - Custom length
 - Nach Mass geschnitten

- ⚠**
- Confezioni profili con quantità fissa, disponibili solo in multipli della quantità indicata.
 - Packs of profiles with fixed quantity, available only in multiples of the indicated quantity.
 - Profilpackungen mit fixer Menge sind nur als Vielfaches der angeführten Menge erhältlich.

- 🚚**
- Trasporto fuori standard. Vedi condizioni di vendita
 - Non-standard transport. See sales conditions
 - Sondertransport. Siehe AGB

POS.	PROD.	ART.	MIS.	Q.TÀ	FIN.	EURO	FIN.	EURO	FIN.	EURO	
A. 250	<p>Biadesivo preinstallato Pre-installed double-side adhesive Selbstklebend</p>	DIV-204-MIX	995 mm	1 pc	AN	46,70 /pc	NO*	54,70 /pc			
			1495 mm	1 pc	AN	52,00 /pc	NO*	62,30 /pc			
			2980 mm	1 pc	AN	68,70 /pc	NO*	81,70 /pc			
		SECTOR 4P	IDIV-204-12 MIX	2980 mm	■ mix 12 pcs	AN	60,00 /pc	NO*	66,50 /pc		
		IDIV-204-30 MIX	2980 mm	■ mix 30 pcs	AN	53,00 /pc	NO*	59,00 /pc			
		IDIV-204-80 MIX	2980 mm	■ mix 80 pcs	AN	43,50 /pc	NO*	47,70 /pc			
<p>• DIV-204 prezzo valido solo con l'acquisto di un'anta PO-290, se acquistato sciolto va calcolata una maggiorazione di € 20,00 per ogni imballo • DIV-204 price valid only for item packed with one panel PO-290. For DIV-204 profiles supplied without PO-290 frames the extra cost for each package unit in € 20,00 • DIV-204 Preis gültig nur mit PO-290 Rahmenprofile verpackt. Aufpreis für DIV-204 Profile ohne PO-290 Rahmenprofile ist € 20,00 pro Verpackungseinheit</p>											
A. 251		P-F25		1 set		86,00 /set					
		IP-F25		■ min 5 set		70,30 /set					
A. 252		PO-292-TS4		1 set		144,70 /set					
		IPO-292-TS4		■ min 5 set	AN	126,30 /set					
A. 253		PO-290-TS4	max 1200 x 3000 mm	1 set	AN	570,00 /set	NO*	684,30 /set			
<p>SEMI-VISIBILE SOFT-CLOSE </p>											
<p>V-1660 ▲ SLIDING 84/85</p>											
A. 254	<p>soft close</p>	V-1660 SET 1 FIX	2000 mm	1 set	AN	444,30 /set					
			3000 mm	1 set	AN	495,30 /set					
			4000 mm	1 set	AN	546,00 /set					
			6000 mm	1 set	AN	651,70 /set					
			1500 → 3000 mm	1 set	AN	564,70 /set					
		V-1660 SET 1 MIS	3000 → 6000 mm	1 set	AN	738,50 /set					
A. 255		V-1660 SET 2 FIX	2000 mm	1 set	AN	674,00 /set					
			3000 mm	1 set	AN	713,70 /set					
			4000 mm	1 set	AN	775,30 /set					
			6000 mm	1 set	AN	877,30 /set					
			1500 → 3000 mm	1 set	AN	781,70 /set					
		V-1660 SET 2 MIS	3000 → 6000 mm	1 set	AN	966,30 /set					

CF

- Prezzi speciali per l'acquisto delle quantità minime indicate (CF) dell'articolo. NB eventuali riordini o aggiunte per completamenti se di quantità inferiore alla minima, saranno fatturati al prezzo normale
- Special prices for the purchase of the minimum quantities indicated (CF) of the article. Note Well: any reorders or additions for completions of quantity less than the minimum will be invoiced at the normal price.
- Artikel mit Sonderpreisen bei Mindestabnahmemengen sind mit (CF) gekennzeichnet. Nachbestellungen oder Ergänzungen unter der Mindestabnahmemenge werden mit dem Normalpreis verrechnet.

NO* Nero opaco - Matt black - Schwarz matt

- Disponibilità da verificare con ufficio commerciale
- Availability to be checked with sales office
- Die Verfügbarkeit ist mit dem Verkaufsbüro abzustimmen

POS.	PROD.	ART.	MIS.	Q.TÀ	FIN.	EURO	FIN.	EURO	FIN.	EURO	
A. 256		V-1660 SET 5 FIX	2000 mm	1 set	AN	887,30 /set					
			3000 mm	1 set	AN	989,00 /set					
			4000 mm	1 set	AN	1090,00 /set					
			6000 mm	1 set	AN	1294,00 /set					
			1500 → 3000 mm	1 set	AN	1079,30 /set					
			3000 → 6000 mm	1 set	AN	1401,50 /set					
V-1660 COMPONENTI / COMPONENTS / EINZELTEILE						▲ SLIDING 87-155					
A. 257		V-1815	2000 mm	1 pc	AN	203,70 /pc					
			3000 mm	1 pc	AN	244,50 /pc					
			4000 mm	1 pc	AN	288,50 /pc					
			6000 mm	1 pc	AN	381,70 /pc					
			V-1815 MIS	1500 → 3000 mm	1 pc	AN	322,00 /pc				
			3000 → 6000 mm	1 pc	AN	475,50 /pc					
A. 258		V-1662		1 set		114,50 /set					
A. 259		V-1824-70 M		1 pc	AN	102,30 /pc					
A. 260		V-1664-1	1000 mm	1 set	AN	166,50 /set					
		V-1664-1,5	1500 mm	1 set	AN	213,00 /set					
A. 261		V-1661-1	1000 mm	2 pc	AN	72,50 /2 pc					
		V-1661-1,5	1500 mm	2 pc	AN	118,50 /2 pc					
A. 262		V-1662-3	3000 mm	min 20 pcs	AN	59,00 /pc					
		V-1662-6	6000 mm	min 10 pcs	AN	84,00 /pc					

- Confezioni industriali
- Industrial packaging
- Industrieverpackungen

- FIX**
- Lunghezza fissa
 - Fixed length
 - Feste Länge

-
- Tagliato dal cliente
 - By installer
 - Schnitt bauseitig

- MIS**
- Tagliato a misura del cliente
 - Custom length
 - Nach Mass geschnitten











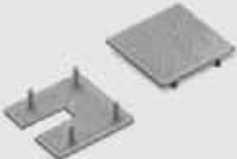

-
- Confezioni profili con quantità fissa, disponibili solo in multipli della quantità indicata.
 - Packs of profiles with fixed quantity, available only in multiples of the indicated quantity.
 - Profilpackungen mit fixer Menge sind nur als Vielfaches der angeführten Menge erhältlich.

-
- Trasporto fuori standard. Vedi condizioni di vendita
 - Non-standard transport. See sales conditions
 - Sondertransport. Siehe AGB

POS.	PROD.	ART.	MIS.	Q.TÀ	FIN.	EURO	FIN.	EURO	FIN.	EURO
A. 263		V-1668		2 pc		20,00 /set				
A. 264		V-1668-C		2 pc		20,00 /2 pc				
		V-1668-C		■ min 50 pcs		4,00 /pc				
A. 265		V-1668-A		■ min 50 pcs		4,00 /pc				
A. 266	 80 Kg x 2 pc	V-104		1 pc		52,30 /pc				
		V-104		■ min 10 pcs		40,70 /pc				
		V-104		■ min 50 pcs		34,70 /pc				
A. 267		V-012		1 pc	AN	18,30 /pc	NS	21,70 /pc	CR	21,70 /pc
		V-012		■ min 5 pcs	AN	12,50 /pc	NS	15,70 /pc	CR	15,70 /pc
A. 268	 Tappo Cap Kappe	V-1815-TA		1 pc	AN	35,30 /pc				
V-1664		▲ SLIDING 155								
A. 269	 80 Kg 80 Kg	V-1664-1	1000 mm	1 set	AN	166,50 /set				
		V-1664-1,5	1500 mm	1 set	AN	213,00 /set				
A. 270		TS-03		1 set		458,30 /set				

CF

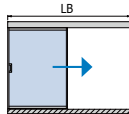
- Prezzi speciali per l'acquisto delle quantità minime indicate (CF) dell'articolo. NB eventuali riordini o aggiunte per completamenti se di quantità inferiore alla minima, saranno fatturati al prezzo normale
- Special prices for the purchase of the minimum quantities indicated (CF) of the article. Note Well: any reorders or additions for completions of quantity less than the minimum will be invoiced at the normal price.
- Artikel mit Sonderpreisen bei Mindestabnahmemengen sind mit (CF) gekennzeichnet. Nachbestellungen oder Ergänzungen unter der Mindestabnahmemenge werden mit dem Normalpreis verrechnet.

POS.	PROD.	ART.	MIS.	Q.TÀ	FIN.	EURO	FIN.	EURO	FIN.	EURO
V-1664 COMPONENTI / COMPONENTS / EINZELTEILE						▲ SLIDING 155				
A. 271	 80 Kg x 2 pc	V-104		1 pc		52,30/pc				
		V-104		■ min 10 pcs		40,70/pc				
				■ min 50 pcs		34,70/pc				
A. 272		V-1668		2 pc		20,00/set				
A. 273		V-1668-C		2 pcs		20,00/set				
		V-1668-C		■ min 50 pcs		4,00/pc				
A. 274		V-1668-A		■ min 50 pcs		4,00/pc				
A. 275		V-1661-1 	1000 mm	2 pcs	AN	72,50/2 pc				
		V-1661-1,5 	1500 mm	2 pcs	AN	118,50/2 pc				
A. 276		V-1662-3 	3000 mm	■ min 20 pcs	AN	59,00/pc				
		V-1662-6 	 6000 mm	■ min 10 pcs	AN	84,00/pc				
EASY FRAME SEMI-VISIBILE										
PO-290-INV						▲ SLIDING 88				
A. 277	 Maniglia non inclusa Handle not included Griff nicht enthalten	PO-290-INV SET 1 MIS 	1500 → 3000 mm	1 set	AN	1359,50/set				
			3000 → 6000 mm	1 set	AN	1874,50/set				





- Confezioni industriali
 - Industrial packaging
 - Industrieverpackungen
- FIX**
- Lunghezza fissa
 - Fixed length
 - Feste Länge

- 
- Tagliato dal cliente
 - Cut by installer
 - Schnitt bauseitig

- MIS** 
- Tagliato a misura del cliente
 - Custom length
 - Nach Mass geschnitten

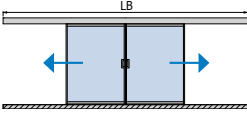
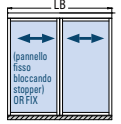
- 
- Confezioni profili con quantità fissa, disponibili solo in multipli della quantità indicata.
 - Packs of profiles with fixed quantity, available only in multiples of the indicated quantity.
 - Profilpackungen mit fixer Menge sind nur als Vielfaches der angeführten Menge erhältlich.

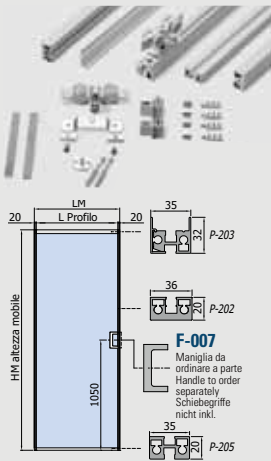
- 
- Trasporto fuori standard. Vedi condizioni di vendita
 - Non-standard transport. See sales conditions
 - Sondertransport. Siehe AGB

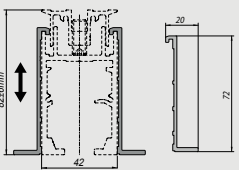
POS.	PROD.	ART.	MIS.	Q.TÀ	FIN.	EURO	FIN.	EURO	FIN.	EURO	
A. 278	 Maniglia non inclusa Handle not included Griff nicht enthalten	PO-290-INV SET 2 MIS	1500 → 3000 mm	1 set	AN	2144,70 /set					
			3000 → 6000 mm	1 set	AN	2661,00 /set					
A. 279	 Maniglia non inclusa Handle not included Griff nicht enthalten	PO-290-INV SET 5 MIS	1500 → 3000 mm	1 set	AN	2718,00 /set					
			3000 → 6000 mm	1 set	AN	3748,70 /set					
PO-290-INV COMPONENTI / COMPONENTS / EINZELTEILE						▲ SLIDING 89					
A. 280		V-1600	2000 mm	1 pc	AN	415,70 /pc					
			3000 mm	1 pc	AN	573,00 /pc					
			4000 mm	1 pc	AN	744,30 /pc					
			 6000 mm	1 pc	AN	1088,00 /pc					
			V-1600 MIS	1500 → 3000 mm	1 pc	AN	641,30 /pc				
				3000 → 6000 mm	1 pc	AN	1218,50 /pc				
A. 281	 max LM 1200 mm x HM 3000 mm	PO-290	1 set	AN	787,30 /set						
A. 282		F-007		1 pair	AN	86,30 /pair					
			F-007	 min 5 pairs	AN	61,00 /pair					
A. 283		V-7006		1 pc	AN	59,30 /m					

CF

- Prezzi speciali per l'acquisto delle quantità minime indicate (CF) dell'articolo. NB eventuali riordini o aggiunte per completamenti se di quantità inferiore alla minima, saranno fatturati al prezzo normale
- Special prices for the purchase of the minimum quantities indicated (CF) of the article. Note Well: any reorders or additions for completions of quantity less than the minimum will be invoiced at the normal price.
- Artikel mit Sonderpreisen bei Mindestabnahmemengen sind mit (CF) gekennzeichnet. Nachbestellungen oder Ergänzungen unter der Mindestabnahmemenge werden mit dem Normalpreis verrechnet.

POS.	PROD.	ART.	MIS.	Q.TÀ	FIN.	EURO	FIN.	EURO	FIN.	EURO	
A. 284		PO-292		1 set		165,50/set					
A. 285		V-1605	1 pc x LB 400 mm	1 pc		37,00/pc					
A. 286		P-F25		1 set		86,00/set					
A. 287		V-1608		2 pc		52,00/set					
A. 288		DIV-204-MIX	995 mm	1 pc	AN	46,70/pc	NO*	54,70/pc			
			1495 mm	1 pc	AN	52,00/pc	NO*	62,30/pc			
			2980 mm	1 pc	AN	68,70/pc	NO*	81,70/pc			
		SECTOR 4P	IDIV-204-12 MIX	2980 mm	■ mix 12 pcs	AN	60,00/pc	NO*	66,50/pc		
		IDIV-204-30 MIX	2980 mm	■ mix 30 pcs	AN	53,00/pc	NO*	59,00/pc			
IDIV-204-80 MIX	2980 mm	■ mix 80 pcs	AN	43,50/pc	NO*	47,70/pc					
<p>Biadesivo preinstallato Pre-installed double-side adhesive Selbstklebend</p> <p>• DIV-204 prezzo valido solo con l'acquisto di un'anta PO-290, se acquistato sciolto va calcolata una maggiorazione di € 20,00 per ogni imballo • DIV-204 price valid only for item packed with one panel PO-290. For DIV-204 profiles supplied without PO-290 frames the extra cost for each package unit in € 20,00 • DIV-204 Preis gültig nur mit PO-290 Rahmenprofile verpackt. Aufpreis für DIV-204 Profile ohne PO-290 Rahmenprofile ist € 20,00 pro Verpackungseinheit</p>											
BRIXIA (OPTIONAL SOFT-CLOSE)											
V-1800				▲ SLIDING 66							
A. 289		V-1800 SET 1 FIX	2000 mm	1 set	AN	264,00/set					
			3000 mm	1 set	AN	299,50/set					
			4000 mm	1 set	AN	346,70/set					
		V-1800 SET 1 MIS	1500 → 3000 mm	1 set	AN	357,00/set					
		3000 → 6000 mm	1 set	AN	517,30/set						

FIX

- Lunghezza fissa
- Fixed length
- Feste Länge



- Tagliato dal cliente
- Cut by installer
- Schnitt bauseitig

MIS

- Tagliato a misura del cliente
- Custom length
- Nach Mass geschnitten



- Trasporto fuori standard. Vedi condizioni di vendita
- Non-standard transport. See sales conditions
- Sondertransport. Siehe AGB

POS.	PROD.	ART.	MIS.	Q.TÀ	FIN.	EURO	FIN.	EURO	FIN.	EURO	
A. 290		V-1800 SET 2 FIX	2000 mm	1 set	AN	403,00/set					
			3000 mm	1 set	AN	440,50/set					
			4000 mm	1 set	AN	484,00/set					
			6000 mm	1 set	AN	564,50/set					
			V-1800 SET 2 MIS	1500 → 3000 mm	1 set	AN	498,00/set				
			3000 → 6000 mm	1 set	AN	658,30/set					
V-1810 ▲ SLIDING 67											
A. 291		V-1810 SET 1 FIX	2000 mm	1 set	AN	273,50/set					
			3000 mm	1 set	AN	317,00/set					
			4000 mm	1 set	AN	369,00/set					
			V-1810 SET 1 MIS	1500 → 3000 mm	1 set	AN	376,00/set				
			3000 → 6000 mm	1 set	AN	550,70/set					
A. 292		V-1810 SET 2 FIX	2000 mm	1 set	AN	418,70/set					
			3000 mm	1 set	AN	460,70/set					
			4000 mm	1 set	AN	513,00/set					
			6000 mm	1 set	AN	596,30/set					
			V-1810 SET 2 MIS	1500 → 3000 mm	1 set	AN	520,00/set				
			3000 → 6000 mm	1 set	AN	694,70/set					
V-1803 ▲ SLIDING 68											
A. 293		V-1803 SET 1 FIX	2000 mm	1 set	AN	378,50/set					
			3000 mm	1 set	AN	463,70/set					
			4000 mm	1 set	AN	559,70/set					
			V-1803 SET 1 MIS	1500 → 3000 mm	1 set	AN	516,00/set				
			3000 → 6000 mm	1 set	AN	817,70/set					
A. 294		V-1803 SET 2 FIX	3000 mm	1 set	AN	620,50/set					
			4000 mm	1 set	AN	716,00/set					
			6000 mm	1 set	AN	883,00/set					
			V-1803 SET 2 MIS	1500 → 3000 mm	1 set	AN	673,30/set				
			3000 → 6000 mm	1 set	AN	974,50/set					
V-1850 ▲ SLIDING 69											
A. 295		V-1850 SET 1 FIX	2000 mm	1 set	AN	240,00/set					
			3000 mm	1 set	AN	279,00/set					
			4000 mm	1 set	AN	327,30/set					
			V-1850 SET 1 MIS	1500 → 3000 mm	1 set	AN	336,50/set				
			3000 → 6000 mm	1 set	AN	500,50/set					

CF

- Prezzi speciali per l'acquisto delle quantità minime indicate (CF) dell'articolo. NB eventuali riordini o aggiunte per completamenti se di quantità inferiore alla minima, saranno fatturati al prezzo normale
- Special prices for the purchase of the minimum quantities indicated (CF) of the article. Note Well: any reorders or additions for completions of quantity less than the minimum will be invoiced at the normal price.
- Artikel mit Sonderpreisen bei Mindestabnahmemengen sind mit (CF) gekennzeichnet. Nachbestellungen oder Ergänzungen unter der Mindestabnahmemenge werden mit dem Normalpreis verrechnet.

POS.	PROD.	ART.	MIS.	Q.TÀ	FIN.	EURO	FIN.	EURO	FIN.	EURO
A. 296		V-1850 SET 2 FIX	2000 mm	1 set	AN	351,30/set				
			3000 mm	1 set	AN	390,30/set				
			4000 mm	1 set	AN	437,30/set				
			6000 mm	1 set	AN	527,70/set				
			V-1850 SET 2 MIS	1500 → 3000 mm	1 set	AN	447,50/set			
			3000 → 6000 mm	1 set	AN	619,50/set				
V-1855 ▲ SLIDING 70										
A. 297		V-1855 SET 1 FIX	2000 mm	1 set	AN	246,70/set				
			3000 mm	1 set	AN	291,30/set				
			4000 mm	1 set	AN	343,50/set				
			V-1855 SET 1 MIS	1500 → 3000 mm	1 set	AN	347,50/set			
			3000 → 6000 mm	1 set	AN	543,30/set				
A. 298		V-1855 SET 2 FIX	3000 mm	1 set	AN	403,50/set				
			4000 mm	1 set	AN	456,00/set				
			6000 mm	1 set	AN	533,30/set				
			V-1855 SET 2 MIS	1500 → 3000 mm	1 set	AN	462,30/set			
			3000 → 6000 mm	1 set	AN	654,70/set				
V-1800 / V-1803 / V-1810 / V-1850 / V-1855 ▲ SLIDING 71/72 COMPONENTI / COMPONENTS / EINZELTEILE										
A. 299		V-1800	2000 mm	1 pc	AN	73,30/pc				
			3000 mm	1 pc	AN	97,30/pc				
			4000 mm	1 pc	AN	128,70/pc				
			6000 mm	1 pc	AN	172,30/pc				
			V-1800 MIS	1500 → 3000 mm	1 pc	AN	149,30/pc			
			3000 → 6000 mm	1 pc	AN	241,00/pc				
A. 300		V-1810	2000 mm	1 pc	AN	90,70/pc				
			3000 mm	1 pc	AN	123,30/pc				
			4000 mm	1 pc	AN	156,00/pc				
			6000 mm	1 pc	AN	221,70/pc				
			V-1810 MIS	1500 → 3000 mm	1 pc	AN	173,00/pc			
			3000 → 6000 mm	1 pc	AN	278,30/pc				
A. 301		V-1803	2000 mm	1 pc	AN	208,30/pc				
			3000 mm	1 pc	AN	279,70/pc				
			4000 mm	1 pc	AN	364,50/pc				
			6000 mm	1 pc	AN	478,50/pc				
			V-1803 MIS	1500 → 3000 mm	1 pc	AN	337,00/pc			
			3000 → 6000 mm	1 pc	AN	573,00/pc				

FIX

- Confezioni industriali
- Industrial packaging
- Industrieverpackungen
- Lunghezza fissa
- Fixed length
- Feste Länge

MIS

- Tagliato dal cliente
- Cut by installer
- Schnitt bauseitig

MIS

- Tagliato a misura del cliente
- Custom length
- Nach Mass geschnitten

- Confezioni profili con quantità fissa, disponibili solo in multipli della quantità indicata.
- Packs of profiles with fixed quantity, available only in multiples of the indicated quantity.
- Profilpackungen mit fixer Menge sind nur als Vielfaches der angeführten Menge erhältlich.

- Trasporto fuori standard. Vedi condizioni di vendita
- Non-standard transport. See sales conditions
- Sondertransport. Siehe AGB

POS.	PROD.	ART.	MIS.	Q.TÀ	FIN.	EURO	FIN.	EURO	FIN.	EURO
A. 302		V-1801	2000 mm	1 pc	AN	57,00 /pc				
			3000 mm	1 pc	AN	72,50 /pc				
			4000 mm	1 pc	AN	91,00 /pc				
			6000 mm	1 pc	AN	117,50 /pc				
		V-1801 MIS	1500 → 3000 mm	1 pc	AN	123,00 /pc				
			3000 → 6000 mm	1 pc	AN	186,30 /pc				
<ul style="list-style-type: none"> • Veletta vendibile solo con binario di pari lunghezza, se acquistata sciolta va calcolata una maggiorazione di € 30,00 per ogni imballo. • Cover profile available only packed with rail profile. For profiles supplied without rails the extra cost for each package unit is € 30,00. • Profilabdeckung lieferbar nur mit Laufschiene verpackt. Aufpreis für Profilabdeckungen ohne Laufschiene ist € 30,00 pro Verpackungseinheit 										
A. 303		V-1851	2000 mm	1 pc	AN	57,00 /pc				
			3000 mm	1 pc	AN	72,30 /pc				
			4000 mm	1 pc	AN	90,50 /pc				
			6000 mm	1 pc	AN	116,70 /pc				
		V-1851 MIS	1500 → 3000 mm	1 pc	AN	121,00 /pc				
			3000 → 6000 mm	1 pc	AN	183,70 /pc				
<ul style="list-style-type: none"> • Veletta vendibile solo con binario di pari lunghezza, se acquistata sciolta va calcolata una maggiorazione di € 30,00 per ogni imballo. • Cover profile available only packed with rail profile. For profiles supplied without rails the extra cost for each package unit is € 30,00. • Profilabdeckung lieferbar nur mit Laufschiene verpackt. Aufpreis für Profilabdeckungen ohne Laufschiene ist € 30,00 pro Verpackungseinheit 										
		IV-1800	3000 mm	■ 4 pcs	AN	85,50 /pc 28,50 /m				
			6000 mm	■ 2 pcs	AN	143,30 /pc 23,88 /m				
		IV-1810	3000 mm	■ 4 pcs	AN	111,30 /pc 37,10 /m				
			6000 mm	■ 2 pcs	AN	173,30 /pc 28,88 /m				
		IV-1803	3000 mm	■ 4 pcs	AN	217,30 /pc 72,43 /m				
			6000 mm	■ 2 pcs	AN	381,00 /pc 63,50 /m				
		TAGLIO-SCORR-UNI Costo per un taglio con misure uguali Cost for cut with same size Preis für einen Schnitt mit gleichen Maß				38,70 /pc				
<p>MINIMO D'ORDINE: 2 profili da 6 mt o 4 profili da 3 mt. (o multipli), anche assortiti tra i vari modelli MINIMUM ORDER: No. 2 - 6 m profiles, or No. 4 - 3 m profiles, (or multiples), also in combination of different models. MINDESTBESTELLMENGE: 2 Profile mit 6 m oder 4 Profile mit 3 m (nur als Vielfaches), auch sortiert nach den verschiedenen Modellen.</p>										

POS.	PROD.	ART.	MIS.	Q.TÀ	FIN.	EURO	FIN.	EURO	FIN.	EURO
		IV-1801-VELETTA	3000 mm ■ 4 pcs		AN	55,70/pc 18,57 /m				
			6000 mm ■ 2 pcs		AN	90,50/pc 15,08 /m				
<ul style="list-style-type: none"> • Veledda vendibile solo con binario di pari lunghezza, se acquistata sciolta va calcolata una maggiorazione di € 30,00 per ogni imballo. • Cover profile available only packed with rail profile. For profiles supplied without rails the extra cost for each package unit is € 30,00. • Profilabdeckung lieferbar nur mit Laufschiene verpackt. Aufpreis für Profilabdeckungen ohne Laufschiene ist € 30,00 pro Verpackungseinheit 										
		IV-1851-VELETTA	3000 mm ■ 4 pcs		AN	55,70/pc 18,57 /m				
			6000 mm ■ 2 pcs		AN	90,50/pc 15,08 /m				
<ul style="list-style-type: none"> • Veledda vendibile solo con binario di pari lunghezza, se acquistata sciolta va calcolata una maggiorazione di € 30,00 per ogni imballo. • Cover profile available only packed with rail profile. For profiles supplied without rails the extra cost for each package unit is € 30,00. • Profilabdeckung lieferbar nur mit Laufschiene verpackt. Aufpreis für Profilabdeckungen ohne Laufschiene ist € 30,00 pro Verpackungseinheit 										
		TAGLIO-SCORR-UNI	Costo per un taglio con misure uguali Cost for cut with same size Preis für einen Schnitt mit gleichen Maß			38,70/pc				
<p>MINIMO D'ORDINE: 2 profili da 6 mt o 4 profili da 3 mt. (o multipli ▲), anche assortiti tra i vari modelli MINIMUM ORDER: No. 2 - 6 m profiles, or No. 4 - 3 m profiles, (or multiples ▲), also in combination of different models. MINDESTBESTELLMENGE: 2 Profile mit 6 m oder 4 Profile mit 3 m (nur als Vielfaches ▲), auch sortiert nach den verschiedenen Modellen.</p>										
A. 304		V-1802		1 set		159,70/set				
		V-1802		■ min 5 set		133,70/set				
A. 305		V-1852		1 set		120,50/set				
		V-1852		■ min 5 set		110,30/set				

- Confezioni industriali
- Industrial packaging
- Industrieverpackungen

- ▲ Confezioni profili con quantità fissa, disponibili solo in multipli della quantità indicata.
- Packs of profiles with fixed quantity, available only in multiples of the indicated quantity.
- Profilpackungen mit fixer Menge sind nur als Vielfaches der angeführten Menge erhältlich.

- Trasporto fuori standard. Vedi condizioni di vendita
- Non-standard transport. See sales conditions
- Sondertransport. Siehe AGB

POS.	PROD.	ART.	MIS.	Q.TÀ	FIN.	EURO	FIN.	EURO	FIN.	EURO
A. 306	 OPTIONAL	V-1806-70		1 pc		86,70 /pc				
		V-1806-70		■ min 5 pcs		77,00 /pc				
A. 307	 OPTIONAL	V-1806-50		1 pc		86,70 /pc				
		V-1806-50		■ min 5 pcs		77,00 /pc				
A. 308	 A B C	V-1817-A / V-1817-B / V-1817-C		1 set	A	33,50 /set	B	33,50 /set	C	33,50 /set
		V-1817-A / V-1817-B / V-1817-C		■ min 5 set	A	27,00 /set	B	27,00 /set	C	27,00 /set
A. 309		V-1807	1 pc x LB 400 mm	1 pc		17,00 /pc				
		V-1807		■ min 10 pcs		14,70 /pc				
A. 310		V-012		1 pc	AN	18,30 /pc	NS	21,70 /pc	CR	21,70 /pc
		V-012		■ min 5 pcs	AN	12,50 /pc	NS	15,70 /pc	CR	15,70 /pc
A. 311		V-090		1 pc		59,00 /pc				
		V-090		■ min 10 pcs		47,30 /pc				
		V-090		■ min 20 pcs		40,70 /pc				
A. 312		V-011-FU		1 pc		33,50 /pc				
		V-011-FU		■ min 10 pcs		28,00 /pc				
		V-011-FU		■ min 20 pcs		25,50 /pc				
A. 313		V-1811		1 pc		50,00 /pc				
		V-1811		■ min 10 pcs		45,30 /pc				

POS.	PROD.	ART.	MIS.	Q.TÀ	FIN.	EURO	FIN.	EURO	FIN.	EURO
A. 314		V-1812		2 pc		22,00/set				
		V-1812		■ min 5 set		17,00/set				
A. 315		V-1808 Per / For / Für V-1800		2 pc	AN	16,30/set				
		V-1808		■ min 5 set	AN	12,50/set				
A. 316		V-1804 Per / For / Für V-1803		2 pc	AN	23,50/set				
		V-1804		■ min 5 set	AN	20,30/set				
A. 317		V-1809 Per / For / Für V-1810		2 pc	AN	16,30/set				
		V-1809		■ min 5 set	AN	12,50/set				
A. 318		V-1859 Per / For / Für V-1855		2 pc	AN	16,30/set				
		V-1859		■ min 5 set	AN	12,50/set				
A. 319		V-1858 Per / For / Für V-1850		2 pc	AN	18,70/set				
		V-1858		■ min 5 set	AN	17,00/set				
A. 320			1000 mm	1 pc		7,30/pc				
		VP-019-MT	2000 mm	1 pc		5,30/pc				
			3000 mm	1 pc		4,70/pc				
			1000 mm	1 pc		7,30/pc				
		VP-018-MT	2000 mm	1 pc		5,30/pc				
			3000 mm	1 pc		4,70/pc				

POS. | PROD. | ART. | MIS. | Q.TÀ | FIN. | EURO | FIN. | EURO | FIN. | EURO

Esempio prezzi al set ricavati da profili con imballo industriale (■) tagliati dal cliente
Example of set prices calculated with profiles in industrial packaging (■), cut by the customer
Beispiel: Set-Preise berechnet mit industriell/verpackten Profile (■), Schnitt bauseitig

PROFILI PROFILES PROFILE	+	KIT COMPONENTI COMPONENTS KIT EINZELTEILE KIT	+	SET SOFT-CLOSE SOFT-CLOSE SET SET SOFT-CLOSE	+	TAPPI+ GUIDA ENDCAPS+GUIDE ENDKAPPEN+FUHRUNG
<p>IV-1800 IV-1801-VELETTA</p> <p>€ 38,96 / m</p>		<p>■ V-1802 80 Kg € 133,70</p>		<p>V-1806</p> <p>OPTIONAL</p>	<p>V-012</p>	
<p>IV-1810 IV-1801-VELETTA</p> <p>€ 43,96 / m</p>			<p>■ V-1806-70 70 Kg € 77,00</p> <p>■ V-1806-50 50 Kg € 77,00</p>	<p>■ V-1808+ ■ V-012 € 12,50 + € 12,50</p>		
<p>IV-1803 IV-1801-VELETTA</p> <p>€ 78,58 / m</p>						
<p>IV-1800 IV-1851-VELETTA</p> <p>€ 38,96 / m</p>			<p>■ V-1852 80 Kg € 110,30</p>	<p>V-1806</p> <p>OPTIONAL</p>	<p>V-012</p>	
<p>IV-1810 IV-1851-VELETTA</p> <p>€ 43,96 / m</p>				<p>■ V-1806-70 70 Kg € 77,00</p> <p>■ V-1806-50 50 Kg € 77,00</p>	<p>■ V-1858+ ■ V-012 € 17,00 + € 12,50</p>	

POS.	PROD.	ART.	MIS.	Q.TÀ	FIN.	EURO	FIN.	EURO	FIN.	EURO
MOOVI SOFT-CLOSE										
V-8200 ▲ SLIDING 100										
A. 321		V-8200 SET 1 FIX	1200 mm AN 1160 mm IXE	1 set	AN	774,30/set	IXE	815,30/set		
		V-8200 SET 1 FIX-CF5	1200 mm AN 1160 mm IXE	■ min 5 sets	AN	666,30/set	IXE	702,30/set		
A. 322		V-8200 SET 2 FIX	1200 mm AN 1160 mm IXE	1 set	AN	1548,00/set	IXE	1629,70/set		
		V-8200 SET 2 FIX-CF5	1200 mm AN 1160 mm IXE	■ min 5 sets	AN	1332,30/set	IXE	1404,00/set		
V-8250 ▲ SLIDING 101										
A. 323		V-8250 SET 1 FIX	1200 mm AN 1160 mm IXE	1 set	AN	781,70/set	IXE	804,30/set		
		V-8250 SET 1 FIX-CF5	1200 mm AN 1160 mm IXE	■ min 5 sets	AN	672,50/set	IXE	692,30/set		
A. 324		V-8250 SET 2 FIX	1200 mm AN 1160 mm IXE	1 set	AN	1562,50/set	IXE	1607,70/set		
		V-8250 SET 2 FIX-CF5	1200 mm AN 1160 mm IXE	■ min 5 sets	AN	1344,50/set	IXE	1384,00/set		
V-8200 / V-8250 ▲ SLIDING 102/103 <i>COMPONENTI / COMPONENTS / EINZELTEILE</i>										
A. 325		V-8200	1192 mm	1 set	AN	632,30/set				
A. 326		V-8203	1200 mm AN 1160 mm IXE	1 pc	AN	92,70/pc	NS	113,50/pc		
A. 327		V-8202	1196 mm	1 pc	AN	60,30/pc	NS	82,30/pc		

- Confezioni industriali
- Industrial packaging
- Industrieverpackungen

- FIX**
- Lunghezza fissa
 - Fixed length
 - Feste Länge

-
- Tagliato dal cliente
 - Cut by installer
 - Schnitt bauseitig

-
- Confezioni profili con quantità fissa, disponibili solo in multipli della quantità indicata.
 - Packs of profiles with fixed quantity, available only in multiples of the indicated quantity.
 - Profilpackungen mit fixer Menge sind nur als Vielfaches der angeführten Menge erhältlich.

POS.	PROD.	ART.	MIS.	Q.TÀ	FIN.	EURO	FIN.	EURO	FIN.	EURO
A. 328		V-8201		1 set	AN	46,70/set	NS	46,70/set		
A. 330		V-8251		1 set	AN	91,50/set	NS	91,50/set		
A. 329		V-8204		1 pair	AN	15,00/pair	IXE	18,70/pair		
MOOVI SOFT-CLOSE LEGNO FOR WOODEN DOOR / FÜR HOLZTÜR										
V-8240 ▲ SLIDING 104										
A. 331		V-8240 SET 1 FIX	1200 mm	1 set	AN	656,50/set				
		V-8240 SET 1 FIX-CF5	1200 mm	■ min 5 sets	AN	565,70/set				
A. 332		V-8240 SET 2 FIX	1200 mm	1 set	AN	1313,00/set				
		V-8240 SET 2 FIX-CF5	1200 mm	■ min 5 sets	AN	1130,50/set				
INDEPENDENT										
V-8000 ▲ SLIDING 106										
A. 333		V-8000 SET 1 FIX	1000 mm	1 set	IXE	1117,30/set	CR	1117,30/set		
		V-8000 SET 1 FIX	1400 mm	1 set	IXE	1515,00/set	CR	1515,00/set		
A. 334		V-8000 SET 2 FIX	1000 mm	1 set	IXE	2234,00/set	CR	2234,00/set		
		V-8000 SET 2 FIX	1400 mm	1 set	IXE	3029,00/set	CR	3048,30/set		

CF

- Prezzi speciali per l'acquisto delle quantità minime indicate (CF) dell'articolo. NB eventuali riordini o aggiunte per completamenti se di quantità inferiore alla minima, saranno fatturati al prezzo normale
- Special prices for the purchase of the minimum quantities indicated (CF) of the article. Note Well: any reorders or additions for completions of quantity less than the minimum will be invoiced at the normal price.
- Artikel mit Sonderpreisen bei Mindestabnahmemengen sind mit (CF) gekennzeichnet. Nachbestellungen oder Ergänzungen unter der Mindestabnahmemenge werden mit dem Normalpreis verrechnet.

POS.	PROD.	ART.	MIS.	Q.TÀ	FIN.	EURO	FIN.	EURO	FIN.	EURO
▲ SLIDING 107										
<div style="display: flex; justify-content: space-between; align-items: center;"> <div style="text-align: center;"> <p>V-8100</p> </div> <div style="text-align: right;"> <p>80 Kg</p> </div> </div>										
A. 335		V-8100 SET 1 FIX	1000 mm	1 set	IXE	1361,50/pc	CR	1361,50/pc		
			1400 mm	1 set	IXE	1790,00/pc	CR	1790,00/pc		
A. 336		V-8100 SET 2 FIX	1000 mm	1 set	IXE	2722,30/pc	CR	2722,30/pc		
			1400 mm	1 set	IXE	3578,30/pc	CR	3578,30/pc		
▲ SLIDING 108										
<div style="display: flex; justify-content: space-between; align-items: center;"> <div style="text-align: center;"> <p>V-8050</p> </div> <div style="text-align: right;"> <p>80 Kg</p> </div> </div>										
A. 337		V-8050 SET 1 FIX	1000 mm	1 set	IXE	1109,50/set	CR	1109,50/set		
			1400 mm	1 set	IXE	1470,70/set	CR	1470,70/set		
A. 338		V-8050 SET 2 FIX	1000 mm	1 set	IXE	2218,30/set	CR	2218,30/set		
			1400 mm	1 set	IXE	2939,50/set	CR	2939,50/set		
▲ SLIDING 109										
<div style="display: flex; justify-content: space-between; align-items: center;"> <div style="text-align: center;"> <p>V-8040</p> </div> <div style="text-align: right;"> <p>80 Kg</p> </div> </div>										
A. 339		V-8040 SET 1 FIX	1000 mm	1 set	IXE	1022,30/set	CR	1022,30/set		
			1400 mm	1 set	IXE	1382,70/set	CR	1382,70/set		
A. 340		V-8040 SET 2 FIX	1000 mm	1 set	IXE	2043,70/set	CR	2043,70/set		
			1400 mm	1 set	IXE	2764,50/set	CR	2764,50/set		
▲ SLIDING 110										
<p>V-8000 / V-8100 / V-8050 / V-8040 COMPONENTI / COMPONENTS / EINZELTEILE</p>										
A. 341		V-8000	1000 mm	1 pc	IXE	116,30/pc				
			1400 mm	1 pc	IXE	174,30/pc				

FIX

- Lunghezza fissa
- Fixed length
- Feste Länge



- Tagliato dal cliente
- Cut by installer
- Schnitt bauseitig

POS.	PROD.	ART.	MIS.	Q.TÀ	FIN.	EURO	FIN.	EURO	FIN.	EURO
A. 342		V-8100	1000 mm	1 pc	IXE	221,70 /pc	CR	221,70 /pc		
			1400 mm	1 pc	IXE	299,00 /pc	CR	299,00 /pc		
A. 343		V-8002		1 set	NS	944,00 /set	CR	944,00 /set		
A. 344		V-8001		1 set	NS	97,00 /set	CR	97,00 /set		
A. 345		V-8101		1 set	IXE	107,50 /set	CR	107,50 /set		
A. 346		V-8051		1 set		73,50 /set				
A. 347		V-012		1 pc	AN	18,30 /pc	NS	21,70 /pc	CR	21,70 /pc
A. 348		V-8005		1 pc	NS	168,00 /pc	CR	168,00 /pc		
A. 349		V-8006		1 set		47,00 /set				
A. 350		P-F08		1 pc		22,00 /pc				

POS.	PROD.	ART.	MIS.	Q.TÀ	FIN.	EURO	FIN.	EURO	FIN.	EURO		
MINIMAL QUADRO RUOTA SOFT-CLOSE												
V-6550 RUOTA QUADRA SQUARE WHEEL COVER / ECKIGE RADABDECKUNG												
▲ SLIDING 90/91												
A. 351		V-6550 SET 1 FIX	2000 mm	1 set	AN	465,00/set	IXE	488,00/set				
			3000 mm	1 set	AN	515,50/set	IXE	551,70/set				
			1500 → 3000 mm	1 set	AN	546,70/set	IXE	582,50/set				
			3000 → 6000 mm	1 set	AN	719,00/set	IXE	789,70/set				
A. 352		V-6550 SET 2 FIX	3000 mm	1 set	AN	778,30/set	IXE	814,30/set				
			4000 mm	1 set	AN	844,30/set	IXE	892,00/set				
			6000 mm	1 set	AN	950,50/set	IXE	1021,50/set				
			1500 → 3000 mm	1 set	AN	809,50/set	IXE	845,30/set				
A. 353		V-6550-T SET 1 FIX	2000 mm	1 set	AN	465,00/set	IXE	488,00/set				
			3000 mm	1 set	AN	515,50/set	IXE	551,70/set				
			1500 → 3000 mm	1 set	AN	546,70/set	IXE	582,50/set				
			3000 → 6000 mm	1 set	AN	719,00/set	IXE	789,70/set				
A. 354		V-6550-T SET 2 FIX	3000 mm	1 set	AN	778,30/set	IXE	814,30/set				
			4000 mm	1 set	AN	844,30/set	IXE	892,00/set				
			6000 mm	1 set	AN	950,50/set	IXE	1021,50/set				
			1500 → 3000 mm	1 set	AN	809,50/set	IXE	845,30/set				
A. 355		V-6550-T SET 2 MIS	3000 → 6000 mm	1 set	AN	982,00/set	IXE	1052,70/set				
			V-6550 / V-6550-T COMPONENTI / COMPONENTS / EINZELTEILE ▲ SLIDING 96/97									
				V-6550	2000 mm	1 pc	AN	202,30/set	IXE	225,50/set	CR	225,50/set
					3000 mm	1 pc	AN	253,00/set	IXE	288,50/set	CR	288,50/set
4000 mm	1 pc	AN			318,50/set	IXE	366,30/set	CR	366,30/set			
6000 mm	1 pc	AN			425,50/set	IXE	496,50/set	CR	496,50/set			
1500 → 3000 mm	1 pc	AN			284,30/pc	IXE	319,70/set	CR	319,70/set			
3000 → 6000 mm	1 pc	AN			487,70/pc	IXE	559,00/set	CR	559,00/set			

FIX

- Confezioni industriali
- Industrial packaging
- Industrieverpackungen
- Lunghezza fissa
- Fixed length
- Feste Länge

MIS

- Tagliato dal cliente
- Cut by installer
- Schnitt bauseitig









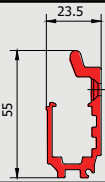

MIS

- Tagliato a misura del cliente
- Custom length
- Nach Mass geschnitten

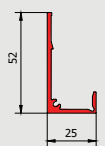
- Confezioni profili con quantità fissa, disponibili solo in multipli della quantità indicata.
- Packs of profiles with fixed quantity, available only in multiples of the indicated quantity.
- Profilpackungen mit fixer Menge sind nur als Vielfaches der angeführten Menge erhältlich.

- Trasporto fuori standard. Vedi condizioni di vendita
- Non-standard transport. See sales conditions
- Sondertransport. Siehe AGB

POS.	PROD.	ART.	MIS.	Q.TÀ	FIN.	EURO	FIN.	EURO	FIN.	EURO
		IV-6550-BIN 	2000 mm	■ 6 pcs	AN	79,30 /pc				
			3000 mm	■ 4 pcs	AN	112,70 /pc				
			6000 mm	■ 2 pcss	AN	214,00 /pc				
		IV-6550-VEL 	2000 mm	■ 6 pcs	AN	43,50 /pc	IXE	67,00 /pc	CR	67,00 /pc
			3000 mm	■ 4 pcs	AN	59,30 /pc	IXE	94,70 /pc	CR	94,70 /pc
			6000 mm	■ 2 pcs	AN	108,30 /pc	IXE	179,50 /pc	CR	179,50 /pc
		<ul style="list-style-type: none"> • Velella vendibile solo con binario di pari lunghezza, se acquistata sciolta va calcolata una maggiorazione di € 30,00 per ogni imballo. • Cover profile available only packed with rail profile. For profiles supplied without rails the extra cost for each package unit is € 30,00. • Profilabdeckung lieferbar nur mit Laufschiene verpackt. Aufpreis für Profilabdeckungen ohne Laufschienen ist € 30,00 pro Verpackungseinheit 								
		TAGLIO-SCORR-UNI Costo per un taglio con misure uguali Cost for cut with same size Preis für einen Schnitt mit gleichen Maß				38,70 /pc				
		MINIMO D'ORDINE: 2 profili da 6 mt o 4 profili da 3 mt o 6 profili da 2 mt. (o multipli), anche assortiti tra i vari modelli MINIMUM ORDER: No. 2 - 6 m profiles, or No. 4 - 3 m profiles, or 6 profiles 2 mt (or multiples), also in combination of different models. MINDESTBESTELLMENGE: 2 Profile mit 6 m oder 4 Profile mit 3 m oder 6 Profile mit 2 mt (nur als Vielfaches), auch sortiert nach den verschiedenen Modellen.								
A. 356		V-6552 • Ruota quadra • Square wheel cover • Eckige Radabdeckung		1 set	AN	239,70 /set	IXE	239,70 /set	CR	239,70 /set
		V-6552		■ min 5 set	AN	169,30 /set	IXE	169,30 /set	CR	169,30 /set
A. 357		V-6552-T • Ruota tonda • Round wheel cover • Runde Radabdeckung		1 set	AN	239,70 /set	IXE	239,70 /set	CR	239,70 /set
		V-6552-T		■ min 5 set	AN	169,30 /set	IXE	169,30 /set	CR	169,30 /set
A. 358		V-012-EVO		1 pc	AN	23,70 /pc	NS	28,30 /pc	CR	31,30 /pc
		V-012-EVO		■ min 10 pc	AN	19,00 /set	IXE	22,30 /set	CR	27,00 /set
MINIMAL QUADRO CON ASTA SOFT-CLOSE										
	V-6520 		▲ SLIDING 94							
A. 359		V-6520 SET 1 FIX	2000 mm	1 set	AN	691,00 /set	IXE	714,00 /set		
			3000 mm	1 set	AN	741,30 /set	IXE	777,30 /set		
		V-6520 SET 1 MIS	1500 → 3000 mm	1 set	AN	772,50 /set	IXE	808,50 /set		
			3000 → 6000 mm	1 set	AN	945,00 /set	IXE	1016,00 /set		
A. 360		V-6520 SET 2 FIX	3000 mm	1 set	AN	1230,50 /set	IXE	1266,00 /set		
			4000 mm	1 set	AN	1296,30 /set	IXE	1343,70 /set		
			6000 mm	1 set	AN	1402,50 /set	IXE	1473,50 /set		
		V-6520 SET 2 MIS	1500 → 3000 mm	1 set	AN	1261,50 /set	IXE	1297,30 /set		
			3000 → 6000 mm	1 set	AN	1433,70 /set	IXE	1504,50 /set		

POS.	PROD.	ART.	MIS.	Q.TÀ	FIN.	EURO	FIN.	EURO	FIN.	EURO
	V-6520 COMPONENTI / COMPONENTS / EINZELTEILE									▲ SLIDING 96/97
A. 361		V-6550	2000 mm	1 pc	AN	202,30/set	IXE	225,50/set	CR	225,50/set
			3000 mm	1 pc	AN	253,00/set	IXE	288,50/set	CR	288,50/set
			4000 mm	1 pc	AN	318,50/set	IXE	366,30/set	CR	366,30/set
			 6000 mm	1 pc	AN	425,50/set	IXE	496,50/set	CR	496,50/set
			1500 → 3000 mm	1 pc	AN	284,30/pc	IXE	319,70/set	CR	319,70/set
			3000 → 6000 mm	1 pc	AN	487,70/pc	IXE	559,00/set	CR	559,00/set
		V-6550 MIS								
		IV-6550-BIN 	2000 mm	■ 6 pcs	AN	79,30/pc				
			3000 mm	■ 4 pcs	AN	112,70/pc				
			 6000 mm	■ 2 pcs	AN	214,00/pc				
		IV-6550-VEL 	2000 mm	■ 6 pcs	AN	43,50/pc	IXE	67,00/pc	CR	67,00/pc
			3000 mm	■ 4 pcs	AN	59,30/pc	IXE	94,70/pc	CR	94,70/pc
			 6000 mm	■ 2 pcs	AN	108,30/pc	IXE	179,50/pc	CR	179,50/pc
			<ul style="list-style-type: none"> • Velella vendibile solo con binario di pari lunghezza, se acquistata sciolta va calcolata una maggiorazione di € 30,00 per ogni imballo. • Cover profile available only packed with rail profile. For profiles supplied without rails the extra cost for each package unit is € 30,00. • Profilabdeckung lieferbar nur mit Laufschiene verpackt. Aufpreis für Profilabdeckungen ohne Laufschiene ist € 30,00 pro Verpackungseinheit 							
		TAGLIO-SCORR-UNI Costo per un taglio con misure uguali Cost for cut with same size Preis für einen Schnitt mit gleichen Maß				38,70/pcs				
		MINIMO D'ORDINE: 2 profili da 6 mt o 4 profili da 3 mt o 6 profili da 2 mt. (o multipli ▲), anche assortiti tra i vari modelli MINIMUM ORDER: No. 2 - 6 m profiles, or No. 4 - 3 m profiles, or 6 profiles 2 mt (or multiples ▲), also in combination of different models. MINDESTBESTELLMENGE: 2 Profile mit 6 m oder 4 Profile mit 3 m oder 6 Profile mit 2 mt (nur als Vielfaches ▲), auch sortiert nach den verschiedenen Modellen.								
A. 362		V-6522		1 set	AN	465,50/set	IXE	465,50/set	CR	465,50/set
		V-6522		■ min 5 set	AN	345,30/set	IXE	345,30/set	CR	345,30/set
A. 363		V-012-EVO		1 pc	AN	23,70/pc	NS	28,30/pc	CR	31,30/pc
		V-012-EVO		■ min 10 pcs	AN	19,00/set	IXE	22,30/set	CR	27,00/set

- Confezioni industriali
 - Industrial packaging
 - Industrieverpackungen
- FIX**
- Lunghezza fissa
 - Fixed length
 - Feste Länge

- 
- MIS**
- Tagliato dal cliente
 - Cut by installer
 - Schnitt bauseitig

- 
- MIS**
- Tagliato a misura del cliente
 - Custom length
 - Nach Mass geschnitten

- 
- Confezioni profili con quantità fissa, disponibili solo in multipli della quantità indicata.
 - Packs of profiles with fixed quantity, available only in multiples of the indicated quantity.
 - Profilpackungen mit fixer Menge sind nur als Vielfaches der angeführten Menge erhältlich.

- 
- Trasporto fuori standard. Vedi condizioni di vendita
 - Non-standard transport. See sales conditions
 - Sondertransport. Siehe AGB

POS.	PROD.	ART.	MIS.	Q.TÀ	FIN.	EURO	FIN.	EURO	FIN.	EURO
MINIMAL TONDO RUOTA SOFT-CLOSE										
V-6750 ▲ SLIDING 92/93										
A. 364		V-6750 SET 1 FIX	2000 mm	1 set	AN	503,00/set	IXE	521,70/set		
			3000 mm	1 set	AN	583,50/set	IXE	610,70/set		
			1500 → 3000 mm	1 set	AN	614,50/set	IXE	642,00/set		
			3000 → 6000 mm	1 set	AN	851,50/set	IXE	905,00/set		
A. 365		V-6750 SET 2 FIX	3000 mm	1 set	AN	847,00/set	IXE	874,30/set		
			4000 mm	1 set	AN	934,30/set	IXE	970,30/set		
			6000 mm	1 set	AN	1083,70/set	IXE	1137,50/set		
			1500 → 3000 mm	1 set	AN	878,00/set	IXE	905,30/set		
		V-6750 SET 2 MIS	3000 → 6000 mm	1 set	AN	1115,00/set	IXE	1168,50/set		
V-6750 ▲ SLIDING 96/97 <i>COMPONENTI / COMPONENTS / EINZELTEILE</i>										
A. 366		V-6750	2000 mm	1 pc	AN	239,70/pc	IXE	258,50/pc	CR	258,50/pc
			3000 mm	1 pc	AN	320,00/pc	IXE	347,50/pc	CR	347,50/pc
			4000 mm	1 pc	AN	407,50/pc	IXE	444,30/pc	CR	444,30/pc
			6000 mm	1 pc	AN	556,50/pc	IXE	611,30/pc	CR	611,30/pc
			1500 → 3000 mm	1 pc	AN	351,30/pc	IXE	378,50/pc	CR	378,50/pc
			3000 → 6000 mm	1 pc	AN	619,30/pc	IXE	673,50/pc	CR	673,50/pc
		IV-6750-BIN	2000 mm	■ 6 pcs	AN	153,70/pc	IXE	182,70/pc	CR	182,70/pc
3000 mm			■ 4 pcs	AN	217,30/pc	IXE	259,50/pc	CR	259,50/pc	
6000 mm			■ 2 pcs	AN	405,30/pc	IXE	492,30/pc	CR	492,30/pc	
		TAGLIO-SCORR-UNI Costo per un taglio con misure uguali Cost for cut with same size Preis für einen Schnitt mit gleichen Maß				38,70/pc				
MINIMO D'ORDINE: 2 profili da 6 mt o 4 profili da 3 mt o 6 profili da 2 mt. (o multipli ▲), anche assortiti tra i vari modelli MINIMUM ORDER: No. 2 - 6 m profiles, or No. 4 - 3 m profiles, or 6 profiles 2 mt (or multiples ▲), also in combination of different models. MINDESTBESTELLMENGE: 2 Profile mit 6 m oder 4 Profile mit 3 m oder 6 Profile mit 2 mt (nur als Vielfaches ▲), auch sortiert nach den verschiedenen Modellen.										
A. 367		V-6752		1 set	AN	240,70/set	IXE	240,70/set	CR	240,70/set
		V-6752		■ min 5 set	AN	171,50/set	IXE	171,50/set	CR	171,50/set
A. 368		V-012-EVO		1 pc	AN	23,70/pc	NS	28,30/pc	CR	31,30/pc
		V-012-EVO		■ min 10 pcs	AN	19,00/set	IXE	22,30/set	CR	27,00/set

POS.	PROD.	ART.	MIS.	Q.TÀ	FIN.	EURO	FIN.	EURO	FIN.	EURO
MINIMAL TONDO CON ASTA SOFT-CLOSE										
V-6720 ▲ SLIDING 95										
A. 369		V-6720 SET 1 FIX	2000 mm	1 set	AN	685,00 /set	IXE	792,30 /set		
			3000 mm	1 set	AN	765,00 /set	IXE	888,70 /set		
		V-6720 SET 1 MIS	1500 → 3000 mm	1 set	AN	796,30 /set	IXE	823,30 /set		
			3000 → 6000 mm	1 set	AN	1033,00 /set	IXE	1087,00 /set		
A. 370		V-6720 SET 2 FIX	3000 mm	1 set	AN	1210,00 /set	IXE	1237,30 /set		
			4000 mm	1 set	AN	1297,50 /set	IXE	1328,00 /set		
		V-6720 SET 2 MIS	6000 mm	1 set	AN	1446,70 /set	IXE	1500,50 /set		
			1500 → 3000 mm	1 set	AN	1241,30 /set	IXE	1268,30 /set		
3000 → 6000 mm	1 set	AN	1478,00 /set	IXE	1531,70 /set					
V-6720 ▲ SLIDING 96/97 <i>COMPONENTI / COMPONENTS / EINZELTEILE</i>										
A. 371		V-6750	2000 mm	1 pc	AN	239,70 /pc	IXE	258,50 /pc	CR	258,50 /pc
			3000 mm	1 pc	AN	320,00 /pc	IXE	347,50 /pc	CR	347,50 /pc
			4000 mm	1 pc	AN	407,50 /pc	IXE	444,30 /pc	CR	444,30 /pc
			6000 mm	1 pc	AN	556,50 /pc	IXE	611,30 /pc	CR	611,30 /pc
		V-6750 MIS	1500 → 3000 mm	1 pc	AN	351,30 /pc	IXE	378,50 /pc	CR	378,50 /pc
			3000 → 6000 mm	1 pc	AN	619,30 /pc	IXE	673,50 /pc	CR	673,50 /pc
	IV-6750-BIN	2000 mm	■ 6 pcs	AN	153,70 /pc	IXE	182,70 /pc	CR	182,70 /pc	
		3000 mm	■ 4 pcs	AN	217,30 /pc	IXE	259,50 /pc	CR	259,50 /pc	
		6000 mm	■ 2 pcs	AN	405,30 /pc	IXE	492,30 /pc	CR	492,30 /pc	
	TAGLIO-SCORR-UNI	Costo per un taglio con misure uguali Cost for cut with same size Preis für einen Schnitt mit gleichen Maß					38,70 /pc			
MINIMO D'ORDINE: 2 profili da 6 mt o 4 profili da 3 mt o 6 profili da 2 mt. (o multipli), anche assortiti tra i vari modelli MINIMUM ORDER: No. 2 - 6 m profiles, or No. 4 - 3 m profiles, or 6 profiles 2 mt (or multiples), also in combination of different models. MINDESTBESTELLMENGE: 2 Profile mit 6 m oder 4 Profile mit 3 m oder 6 Profile mit 2 mt (nur als Vielfaches), auch sortiert nach den verschiedenen Modellen.										
A. 372		V-6722		1 set	AN	423,00 /set	IXE	423,00 /set	CR	423,00 /set
		V-6722	■ min 10 set		AN	311,70 /pc	IXE	311,70 /pc	CR	311,70 /pc
A. 373		V-012-EVO		1 pc	AN	23,70 /pc	NS	28,30 /pc	CR	31,30 /pc
		V-012-EVO	■ min 10 pc		AN	19,00 /set	IXE	22,30 /set	CR	27,00 /set

- Confezioni industriali
 - Industrial packaging
 - Industrieverpackungen
- FIX**
- Lunghezza fissa
 - Fixed length
 - Feste Länge

- MIS**
- Tagliato dal cliente
 - Cut by installer
 - Schnitt bauseitig

- MIS**
- Tagliato a misura del cliente
 - Custom length
 - Nach Mass geschnitten

- Warning**
- Confezioni profili con quantità fissa, disponibili solo in multipli della quantità indicata.
 - Packs of profiles with fixed quantity, available only in multiples of the indicated quantity.
 - Profilpackungen mit fixer Menge sind nur als Vielfaches der angeführten Menge erhältlich.

- Warning**
- Trasporto fuori standard. Vedi condizioni di vendita
 - Non-standard transport. See sales conditions
 - Sondertransport. Siehe AGB

POS. | PROD. | ART. | MIS. | Q.TÀ | FIN. | EURO | FIN. | EURO | FIN. | EURO

Esempio prezzi al set ricavati da profili con imballo industriale (■) tagliati dal cliente
Example of set prices calculated with profiles in industrial packaging (■), cut by the customer
Beispiel: Set-Preise berechnet mit industriell/verpackten Profile (■), Schnitt bauseitig

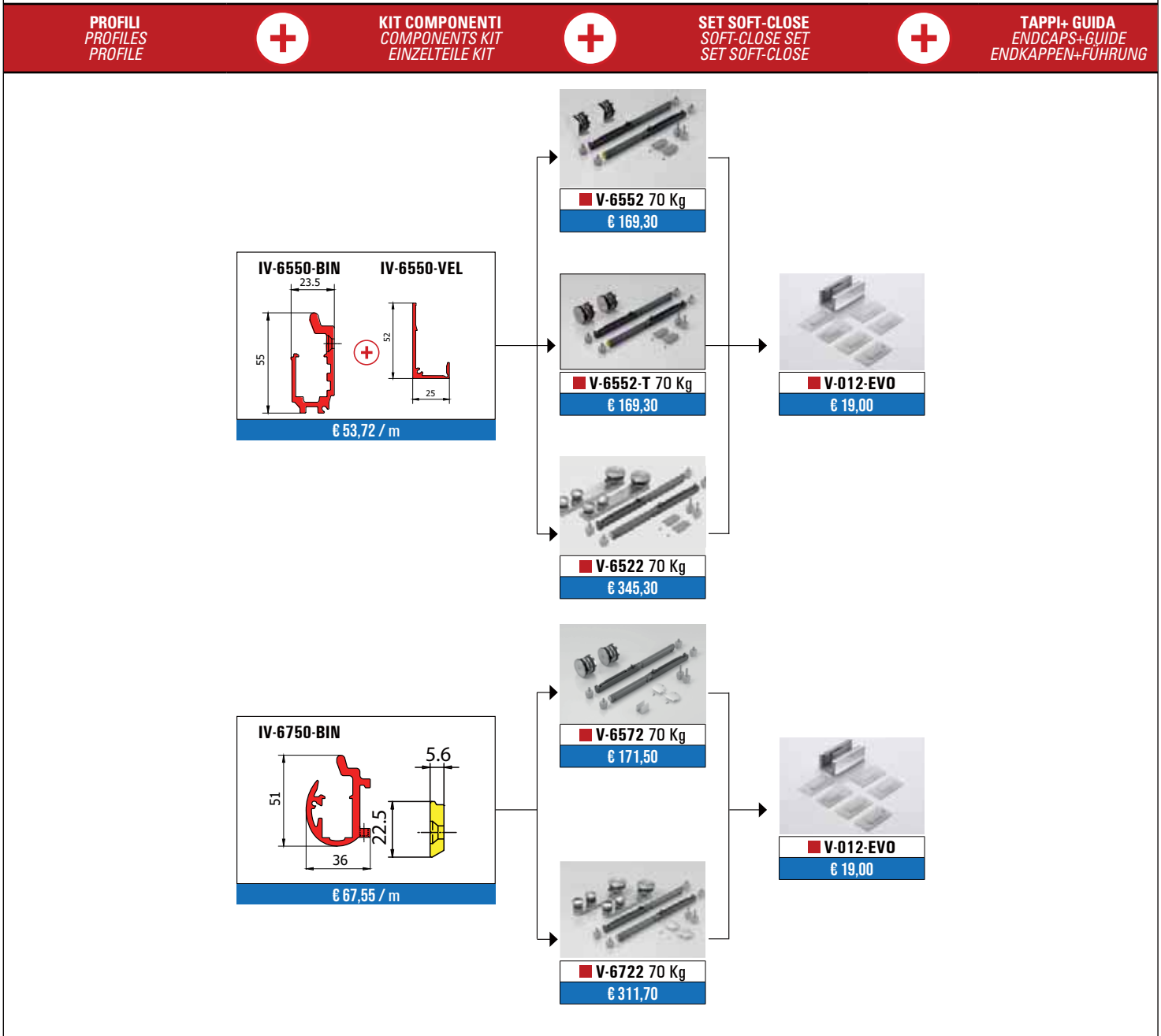

POS.	PROD.	ART.	MIS.	Q.TÀ	FIN.	EURO	FIN.	EURO	FIN.	EURO
------	-------	------	------	------	------	------	------	------	------	------

ROLLING CENTER										
<div style="display: flex; justify-content: space-between; align-items: center;"> <div style="display: flex; align-items: center;"> <div style="margin-left: 5px;"> R-1000 100 Kg </div> </div> <div style="text-align: right;"> ▲ SLIDING 112 </div> </div>										
A. 374		R-1000 SET 1 MIS	1500 → 2500 mm	1 set		IXE 1562,30/set				
A. 375		R-1000 SET 2 MIS	2500 → 5000 mm	1 set		IXE 2868,00/set				
A. 376		R-1000 SET 3 MIS	2500 → 5000 mm	1 set		IXE 3823,50/set				
<div style="display: flex; justify-content: space-between; align-items: center;"> <div> R-1000 COMPONENTI / COMPONENTS / EINZELTEILE </div> <div style="text-align: right;"> ▲ SLIDING 115/116 </div> </div>										
A. 377		R-1000 MIS				IXE 122,00/m				
A. 378		R-1012 MIS				IXE 40,70/m				
<ul style="list-style-type: none"> • Profilo vendibile solo con binario di pari lunghezza, se acquistata sciolta va calcolata una maggiorazione di € 30,00 per ogni imballo. • Profile available only packed with rail profile. For profiles supplied without rails the extra cost for each package unit is € 30,00. • Profil lieferbar nur mit Laufschiene verpackt. Aufpreis für Profilabdeckungen ohne Laufschiene ist € 30,00 pro Verpackungseinheit 										
A. 379		R-2012 MIS				IXE 29,50/m				
A. 380		R-1002				IXE 33,30/2 pc				

MIS

- Tagliato a misura del cliente
- Custom length
- Nach Mass geschnitten

POS.	PROD.	ART.	MIS.	Q.TÀ	FIN.	EURO	FIN.	EURO	FIN.	EURO
A. 381		R-1006		2 pcs	AN	237,50/set				
A. 382		R-1005		1 pc	IXE	448,00/pc				
A. 383		R-1007	1 pc x L 250 mm	1 pc		16,30/pc				
A. 384		R-1004	1 pc x L 250 mm	1 pc	AN	17,00/pc				
A. 385		R-1008	1 pc x L 250 mm	1 pc		33,30/pc				
A. 386		R-1009	1 pc x L 250 mm	1 pc		42,00/pc				
A. 387		R-1013		1 set		30,50/set				
A. 388		PG-CHIAVE		1 pc	IX	41,70/pc				

POS.	PROD.	ART.	MIS.	Q.TÀ	FIN.	EURO	FIN.	EURO	FIN.	EURO
ROLLIE										
VL-6100 ▲ SLIDING 113										
A. 389		VL-6100 SET 1 FIX	2000 mm	1 set	IX	457,70 /set				
A. 390		VL-6100 SET 2 FIX	2000 + 2000 mm	1 set	IX	917,30 /set				
VL-6100 COMPONENTI / COMPONENTS / EINZELTEILE ▲ SLIDING 115/116										
A. 391		VL-6103		1 pc	IX	117,00 /pc				
A. 392		VL-3005		1 pc	IX	44,70 /m				
A. 393		VL-6104		1 pc	IX	55,70 /pc				
A. 394		VL-3008		2 pcs	IX	41,00 /2 pc				
A. 395		VL-3002		1 pc	IX	26,30 /pc				
A. 396		VL-3001		1 pc	IX	41,50 /pc				
A. 397		VL-054		1 pc	IX	30,50 /pc				

FIX

- Lunghezza fissa
- Fixed length
- Feste Länge



- Tagliato dal cliente
- Cut by installer
- Schnitt bauseitig

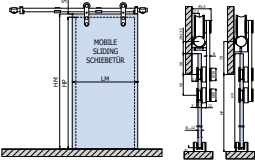
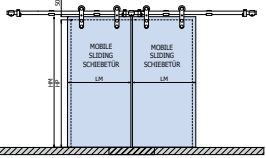
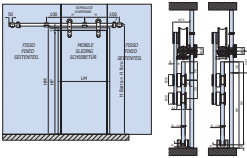
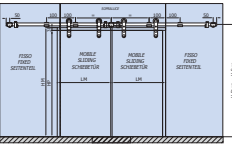
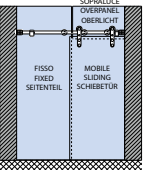
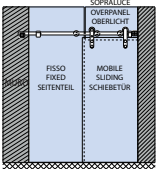
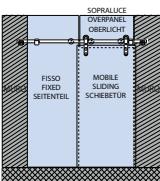





POS.	PROD.	ART.	MIS.	Q.TÀ	FIN.	EURO	FIN.	EURO	FIN.	EURO
SLIDING TECH										
VL-3000  70 Kg ▲ SLIDING 114										
A. 398		VL-3000 SET 1 FIX	2000 mm	1 set	IX	487,70/set				
A. 399		VL-3000 SET 2 FIX	2000 + 2000 mm	1 set	IX	974,50/set				
A. 400		VL-3000 SET 6	2000 mm	1 set	IX	722,50/set				
A. 401		VL-3000 SET 7	2000 + 2000 mm	1 set	IX	1433,30/set				
A. 402		VL-3000 SET 3 FIX	2000 mm	1 set	IX	974,50/set				
A. 403		VL-3000 SET 4 FIX	2000 mm	1 set	IX	860,00/set				
A. 404		VL-3000 SET 5 FIX	2000 mm	1 set	IX	757,00/set				

POS.	PROD.	ART.	MIS.	Q.TÀ	FIN.	EURO	FIN.	EURO	FIN.	EURO
A. 405		VL-3000 SET 8 MIS	1500 → 2500 mm	1 set	IX	1639,00/set				
A. 406		VL-3000 SET 9 MIS	1500 → 2500 mm	1 set	IX	1875,00/set				
A. 407		VL-3000 SET 10 MIS	2500 → 5000 mm	1 set	IX	2499,50/set				
A. 408		VL-3000 SET 11 MIS	2500 → 5000 mm	1 set	IX	2638,50/set				
SLIDING TECH LEGNO FOR WOODEN DOOR / FÜR HOLZTÜR										
VL-3040										
A. 409		VL-3040 SET 1 FIX	2000 mm	1 set	IX	619,50/set				
A. 410		VL-3040 SET 2 FIX	2000 + 2000 mm	1 set	IX	1238,50/set				
VL-3000 COMPONENTI / COMPONENTS / EINZELTEILE ▲ SLIDING 115/116										
A. 411		VL-3003		1 pc	IX	211,30/pc				

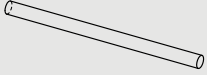
FIX
 • Lunghezza fissa
 • Fixed length
 • Feste Länge

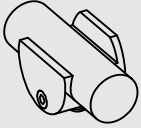
MIS
 • Tagliato dal cliente
 • Cut by installer
 • Schnitt bauseitig

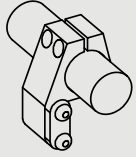
MIS
 • Tagliato a misura del cliente
 • Custom length
 • Nach Mass geschnitten

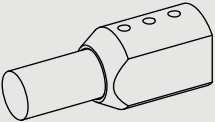
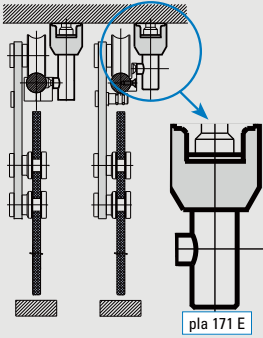
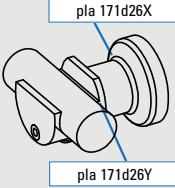
POS.	PROD.	ART.	MIS.	Q.TÀ	FIN.	EURO	FIN.	EURO	FIN.	EURO
A. 412		VL-3005 MIS 		1 pc	IX	44,70/m				
A. 413		VL-3008		2 pcs	IX	41,00/set				
A. 414		VL-3001		1 pc	IX	41,50/pc				
A. 415		VL-3002		1 pc	IX	26,30/pc				
A. 416		VL-3004		1 pc	IX	57,00/pc				
A. 417		VL-054		1 pc	IX	30,50/pc				
A. 418		PLA 171d23		1 pc	IX	84,30/pc				
A. 419		PLA 171 E		1 pc	IX	167,00/pc				
A. 420		PLA 171d26-X		1 pc	IX	38,50/pc				

POS.	PROD.	ART.	MIS.	Q.TÀ	FIN.	EURO	FIN.	EURO	FIN.	EURO
A. 421		PLA 171d26-Y8	8 mm	1 pc	IX	28,30 / pc				
		PLA 171d26-Y11	11 mm	1 pc	IX	28,30 / pc				
		PLA 171d26-Y36	36 mm	1 pc	IX	42,50 / pc				
A. 422		VL-3006		1 pc	IX	69,50 / pc				
A. 423		VL-3007		1 pc	IX	46,70 / pc				

BRIXIA TELESCOPICO 2 VIE (OPTIONAL SOFT-CLOSE)

V-1820 SINCRO TRASCINAMENTO CON FUNE
SINCRO DRAGGING SYSTEM WITH CABLE / SINCRO MITNEHMER KIT MIT SEILZUG



▲ SLIDING 118/119

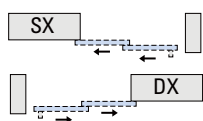

- Indicare sempre il senso di apertura
- Please specify always opening direction
- Bitte immer Öffnungsrichtung angeben

A. 424		V-1820 SET 1 FIX	2000 mm	1 set	AN	1202,30 / set	IXE	1360,00 / set			
			3000 mm	1 set	AN	1408,50 / set	IXE	1560,00 / set			
			4000 mm	1 set	AN	1642,30 / set	IXE	1787,30 / set			
			6000 mm	1 set	AN	2050,30 / set	IXE	2204,00 / set			
			V-1820 SET 1 MIS	1500 → 3000 mm	1 set	AN	1513,50 / set	IXE	1716,50 / set		
			3000 → 6000 mm	1 set	AN	2142,30 / set	IXE	2384,50 / set			
A. 425		V-1820 SET 2 FIX	2000 mm	1 set	AN	1213,70 / set	IXE	1407,50 / set			
			3000 mm	1 set	AN	1436,70 / set	IXE	1665,00 / set			
			4000 mm	1 set	AN	1666,50 / set	IXE	1910,50 / set			
			6000 mm	1 set	AN	2127,30 / set	IXE	2405,50 / set			
			V-1820 SET 2 MIS	1500 → 3000 mm	1 set	AN	1517,30 / set	IXE	1766,70 / set		
			3000 → 6000 mm	1 set	AN	2314,30 / set	IXE	2508,50 / set			

FIX

- Lunghezza fissa
- Fixed length
- Feste Länge



- Tagliato dal cliente
- Cut by installer
- Schnitt bauseitig

MIS

- Tagliato a misura del cliente
- Custom length
- Nach Mass geschnitten



- Trasporto fuori standard. Vedi condizioni di vendita
- Non-standard transport. See sales conditions
- Sondertransport. Siehe AGB

POS.	PROD.	ART.	MIS.	Q.TÀ	FIN.	EURO	FIN.	EURO	FIN.	EURO	
V-1870 TRASCINAMENTO MECCANICO MECHANICAL DRAGGING SYSTEM / MIT MECHANISCHEM MITNEHMER <div style="float: right;"> ▲ SLIDING 118/119 </div>											
		<ul style="list-style-type: none"> • Indicare sempre il senso di apertura • Please specify always opening direction • Bitte immer Öffnungsrichtung angeben 									
A. 426	<p>V-1870 SET 1 FIX</p>	2000 mm	1 set	AN	949,30/set	IXE	1082,70/set				
		3000 mm	1 set	AN	1109,50/set	IXE	1282,30/set				
		4000 mm	1 set	AN	1306,70/set	IXE	1510,00/set				
		6000 mm	1 set	AN	1643,50/set	IXE	1927,00/set				
		V-1870 SET 1 MIS	1500 → 3000 mm	1 set	AN	1207,30/set	IXE	1439,30/set			
		3000 → 6000 mm	1 set	AN	1731,70/set	IXE	2107,30/set				
A. 427	<p>V-1870 SET 2 FIX</p>	2000 mm	1 set	AN	956,70/set	IXE	1130,30/set				
		3000 mm	1 set	AN	1141,70/set	IXE	1388,00/set				
		4000 mm	1 set	AN	1339,50/set	IXE	1633,30/set				
		6000 mm	1 set	AN	1729,50/set	IXE	2128,50/set				
		V-1870 SET 2 MIS	1500 → 3000 mm	1 set	AN	1211,30/set	IXE	1490,00/set			
		3000 → 6000 mm	1 set	AN	1897,50/set	IXE	2231,30/set				
A. 428	<p>V-1820 SET 5 FIX</p>	2000 mm	1 set	AN	886,50/set	IXE	986,70/set				
		3000 mm	1 set	AN	1036,50/set	IXE	1164,70/set				
		V-1820 SET 5 MIS	1500 → 3000 mm	1 set	AN	1069,70/set	IXE	1321,30/set			
		3000 → 6000 mm	1 set	AN	1565,00/set	IXE	1988,30/set				

BRIXIA TELESCOPICO 2 VIE + FISSO (OPTIONAL SOFT-CLOSE)

V-1825 SINCRO TRASCINAMENTO CON FUNE SINCRO DRAGGING SYSTEM WITH CABLE / SINCRO MITNEHMER KIT MIT SEILZUG <div style="float: right;"> ▲ SLIDING 120/121 </div>											
		<ul style="list-style-type: none"> • Indicare sempre il senso di apertura • Please specify always opening direction • Bitte immer Öffnungsrichtung angeben 									
A. 429	<p>V-1825 SET 1 FIX</p>	2000 mm	1 set	AN	1281,30/set	IXE	1415,30/set				
		3000 mm	1 set	AN	1504,50/set	IXE	1635,70/set				
		4000 mm	1 set	AN	1767,70/set	IXE	1878,50/set				
		6000 mm	1 set	AN	2204,00/set	IXE	2341,30/set				
		V-1825 SET 1 MIS	1500 → 3000 mm	1 set	AN	1672,00/set	IXE	1781,70/set			
		3000 → 6000 mm	1 set	AN	2431,00/set	IXE	2512,70/set				
A. 430	<p>V-1825 SET 2 FIX</p>	2000 mm	1 set	AN	1375,00/set	IXE	1582,00/set				
		3000 mm	1 set	AN	1643,50/set	IXE	1902,70/set				
		4000 mm	1 set	AN	1953,00/set	IXE	2211,70/set				
		6000 mm	1 set	AN	2477,30/set	IXE	2841,70/set				
		V-1825 SET 2 MIS	1500 → 3000 mm	1 set	AN	1810,00/set	IXE	2048,50/set			
		3000 → 6000 mm	1 set	AN	2705,30/set	IXE	3013,00/set				

POS.	PROD.	ART.	MIS.	Q.TÀ	FIN.	EURO	FIN.	EURO	FIN.	EURO	
V-1875 TRASCINAMENTO MECCANICO <i>MECHANICAL DRAGGING SYSTEM / MIT MECHANISCHEM MITNEHMER</i>											
								▲ SLIDING 120/121			
<ul style="list-style-type: none"> • Indicare sempre il senso di apertura • Please specify always opening direction • Bitte immer Öffnungsrichtung angeben 											
A. 431		V-1875 SET 1 FIX	2000 mm	1 set	AN	1059,30 /set	IXE	1138,00 /set			
			3000 mm	1 set	AN	1236,70 /set	IXE	1359,00 /set			
			4000 mm	1 set	AN	1488,00 /set	IXE	1600,70 /set			
			6000 mm	1 set	AN	1865,00 /set	IXE	2064,30 /set			
			V-1875 SET 1 MIS	1500 → 3000 mm	1 set	AN	1420,00 /set	IXE	1504,00 /set		
			3000 → 6000 mm	1 set	AN	2092,50 /set	IXE	2235,30 /set			
A. 432		V-1875 SET 2 FIX	2000 mm	1 set	AN	1168,50 /set	IXE	1304,30 /set			
			3000 mm	1 set	AN	1391,00 /set	IXE	1625,70 /set			
			4000 mm	1 set	AN	1687,00 /set	IXE	1934,50 /set			
			6000 mm	1 set	AN	2154,30 /set	IXE	2564,50 /set			
			V-1875 SET 2 MIS	1500 → 3000 mm	1 set	AN	1624,00 /set	IXE	1771,00 /set		
			3000 → 6000 mm	1 set	AN	2381,00 /set	IXE	2735,70 /set			

BRIXIA TELESCOPICO 3 VIE (OPTIONAL SOFT-CLOSE)







V-1830 SINCRO TRASCINAMENTO CON FUNE <i>SINCRO DRAGGING SYSTEM WITH CABLE / SINCRO MITNEHMER KIT MIT SEILZUG</i>											
								▲ SLIDING 122/123			
<ul style="list-style-type: none"> • Indicare sempre il senso di apertura • Please specify always opening direction • Bitte immer Öffnungsrichtung angeben 											
A. 433		V-1830 SET 1 FIX	2000 mm	1 set	AN	1787,30 /set	IXE	2020,70 /set			
			3000 mm	1 set	AN	2036,30 /set	IXE	2319,30 /set			
			4000 mm	1 set	AN	2852,00 /set	IXE	3116,30 /set			
			6000 mm	1 set	AN	2852,00 /set	IXE	3116,30 /set			
			V-1830 SET 1 MIS	1500 → 3000 mm	1 set	AN	2103,30 /set	IXE	2581,30 /set		
			3000 → 6000 mm	1 set	AN	2955,00 /set	IXE	3386,70 /set			
A. 434		V-1830 SET 2 FIX	2000 mm	1 set	AN	1807,30 /set	IXE	2078,00 /set			
			3000 mm	1 set	AN	2154,30 /set	IXE	2440,30 /set			
			4000 mm	1 set	AN	3105,00 /set	IXE	3347,00 /set			
			6000 mm	1 set	AN	3105,00 /set	IXE	3347,00 /set			
			V-1830 SET 2 MIS	1500 → 3000 mm	1 set	AN	2242,50 /set	IXE	2647,30 /set		
			3000 → 6000 mm	1 set	AN	3238,30 /set	IXE	3539,50 /set			

FIX
 • Lunghezza fissa
 • Fixed length
 • Feste Länge



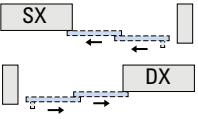
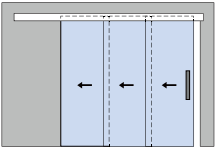

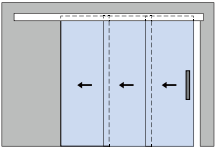

MIS
 • Tagliato dal cliente
 • Cut by installer
 • Schnitt bauseitig

MIS
 • Tagliato a misura del cliente
 • Custom length
 • Nach Mass geschnitten

Trasporto fuori standard
 • Trasporto fuori standard. Vedi condizioni di vendita
 • Non-standard transport. See sales conditions
 • Sondertransport. Siehe AGB

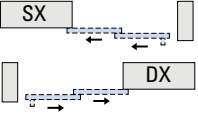
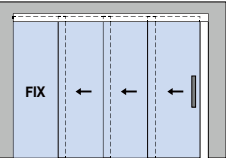
POS.	PROD.	ART.	MIS.	Q.TÀ	FIN.	EURO	FIN.	EURO	FIN.	EURO	
V-1880 TRASCINAMENTO MECCANICO <i>MECHANICAL DRAGGING SYSTEM / MIT MECHANISCHEM MITNEHMER</i>   ▲ SLIDING 122/123											
<div style="display: flex; justify-content: space-between;"> <div style="width: 20%;">  </div> <div style="width: 60%;"> <ul style="list-style-type: none"> • Indicare sempre il senso di apertura • Please specify always opening direction • Bitte immer Öffnungsrichtung angeben </div> <div style="width: 15%;"></div> </div>											
A. 435	 <p>V-1880 SET 1 FIX</p>	2000 mm	1 set	AN	1453,30 /set	IXE	1642,30 /set				
		3000 mm	1 set	AN	1672,00 /set	IXE	1940,70 /set				
		4000 mm	1 set	AN	2375,00 /set	IXE	2737,70 /set				
		 6000 mm	1 set	AN	2375,00 /set	IXE	2737,70 /set				
		V-1880 SET 1 MIS 	1500 → 3000 mm	1 set	AN	1753,70 /set	IXE	2202,70 /set			
		3000 → 6000 mm	1 set	AN	2467,00 /set	IXE	3008,00 /set				
A. 436	 <p>V-1880 SET 2 FIX</p>	2000 mm	1 set	AN	1488,00 /set	IXE	1699,00 /set				
		3000 mm	1 set	AN	1808,70 /set	IXE	2061,50 /set				
		4000 mm	1 set	AN	2687,50 /set	IXE	2968,00 /set				
		 6000 mm	1 set	AN	2687,50 /set	IXE	2968,00 /set				
		V-1880 SET 2 MIS 	1500 → 3000 mm	1 set	AN	1892,30 /set	IXE	2269,00 /set			
		3000 → 6000 mm	1 set	AN	2798,30 /set	IXE	3161,00 /set				

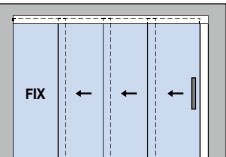
BRIXIA TELESCOPICO 3 VIE + FISSO (OPTIONAL SOFT-CLOSE)

V-1835 SINCRÒ TRASCINAMENTO CON FUNE <i>SINCRÒ DRAGGING SYSTEM WITH CABLE / SINCRÒ MITNEHMER KIT MIT SEILZUG</i>    ▲ SLIDING 124/125											
<div style="display: flex; justify-content: space-between;"> <div style="width: 20%;">  </div> <div style="width: 60%;"> <ul style="list-style-type: none"> • Indicare sempre il senso di apertura • Please specify always opening direction • Bitte immer Öffnungsrichtung angeben </div> <div style="width: 15%;"></div> </div>											
A. 437	 <p>V-1835 SET 1 FIX</p>	2000 mm	1 set	AN	1847,30 /set	IXE	2075,50 /set				
		3000 mm	1 set	AN	2152,50 /set	IXE	2395,30 /set				
		4000 mm	1 set	AN	3061,30 /set	IXE	3253,70 /set				
		 6000 mm	1 set	AN	3061,30 /set	IXE	3253,70 /set				
		V-1835 SET 1 MIS 	1500 → 3000 mm	1 set	AN	2309,00 /set	IXE	2646,30 /set			
		3000 → 6000 mm	1 set	AN	3250,00 /set	IXE	3514,70 /set				
A. 438	 <p>V-1835 SET 2 FIX</p>	2000 mm	1 set	AN	1956,30 /set	IXE	2252,00 /set				
		3000 mm	1 set	AN	2306,70 /set	IXE	2677,70 /set				
		4000 mm	1 set	AN	3364,30 /set	IXE	3782,70 /set				
		 6000 mm	1 set	AN	3364,30 /set	IXE	3782,70 /set				
		V-1835 SET 2 MIS 	1500 → 3000 mm	1 set	AN	2422,50 /set	IXE	2928,50 /set			
		3000 → 6000 mm	1 set	AN	3529,50 /set	IXE	4044,00 /set				

POS.	PROD.	ART.	MIS.	Q.TÀ	FIN.	EURO	FIN.	EURO	FIN.	EURO	
V-1885 TRASCINAMENTO MECCANICO <i>MECHANICAL DRAGGING SYSTEM / MIT MECHANISCHEM MITNEHMER</i>								▲ SLIDING 124/125			
<ul style="list-style-type: none"> • Indicare sempre il senso di apertura • Please specify always opening direction • Bitte immer Öffnungsrichtung angeben 											
A. 439	<p>V-1885 SET 1 FIX</p>			2000 mm	1 set	AN	1620,00/set	IXE	1697,50/set		
				3000 mm	1 set	AN	1913,00/set	IXE	2016,50/set		
				4000 mm	1 set	AN	2781,50/set	IXE	2875,30/set		
				6000 mm	1 set	AN	2781,50/set	IXE	2875,30/set		
			V-1885 SET 1 MIS			1500 → 3000 mm	1 set	AN	2078,00/set	IXE	2267,70/set
						3000 → 6000 mm	1 set	AN	2980,00/set	IXE	3136,30/set
A. 440	<p>V-1885 SET 2 FIX</p>			2000 mm	1 set	AN	1738,30/set	IXE	1989,30/set		
				3000 mm	1 set	AN	2076,70/set	IXE	2299,00/set		
				4000 mm	1 set	AN	3103,70/set	IXE	3404,50/set		
				6000 mm	1 set	AN	3103,70/set	IXE	3404,50/set		
			V-1885 SET 2 MIS			1500 → 3000 mm	1 set	AN	2199,00/set	IXE	2550,50/set
						3000 → 6000 mm	1 set	AN	3278,00/set	IXE	3665,50/set
V-1820 / V-1870 / V-1825 / V-1875 / V-1830 / V-1880 / V-1835 / V-1885 <i>COMPONENTI / COMPONENTS / EINZELTEILE</i>						▲ SLIDING 126/129					
A. 441	<p>V-1820</p>			2000 mm	1 pc	AN	304,70/pc				
				3000 mm	1 pc	AN	420,30/pc				
				4000 mm	1 pc	AN	549,70/pc				
				6000 mm	1 pc	AN	790,30/pc				
			V-1820 MIS			1500 → 3000 mm	1 pc	AN	468,00/pc		
						3000 → 6000 mm	1 pc	AN	815,70/pc		
A. 442	<p>V-1830</p>			2000 mm	1 pc	AN	483,30/pc				
				3000 mm	1 pc	AN	698,00/pc				
				6000 mm	1 pc	AN	1219,50/pc				
			V-1830 MIS			1500 → 3000 mm	1 pc	AN	850,30/pc		
				3000 → 6000 mm	1 pc	AN	1335,30/pc				
A. 443	<p>V-1821</p>			2000 mm	1 pc	AN	70,50/pc	IXE	120,30/pc		
				3000 mm	1 pc	AN	97,00/pc	IXE	162,50/pc		
				4000 mm	1 pc	AN	122,00/pc	IXE	211,30/pc		
				6000 mm	1 pc	AN	153,00/pc	IXE	300,00/pc		
			V-1821 MIS			1500 → 3000 mm	1 pc	AN	152,70/pc	IXE	217,00/pc
						3000 → 6000 mm	1 pc	AN	230,70/pc	IXE	377,30/pc
<ul style="list-style-type: none"> • Velella vendibile solo con binario di pari lunghezza, se acquistata sciolta va calcolata una maggiorazione di € 30,00 per ogni imballo. • Cover profile available only packed with rail profile. For profiles supplied without rails the extra cost for each package unit is € 30,00. • Profilabdeckung lieferbar nur mit Laufschiene verpackt. Aufpreis für Profilabdeckungen ohne Laufschiene ist € 30,00 pro Verpackungseinheit 											

FIX

- Confezioni industriali
- Industrial packaging
- Industrieverpackungen
- Lunghezza fissa
- Fixed length
- Feste Länge

MIS

- Tagliato dal cliente
- Cut by installer
- Schnitt bauseitig









MIS

- Tagliato a misura del cliente
- Custom length
- Nach Mass geschnitten

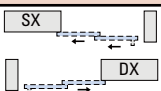
- Confezioni profili con quantità fissa, disponibili solo in multipli della quantità indicata.
- Packs of profiles with fixed quantity, available only in multiples of the indicated quantity.
- Profilpackungen mit fixer Menge sind nur als Vielfaches der angeführten Menge erhältlich.

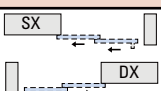
- Trasporto fuori standard. Vedi condizioni di vendita
- Non-standard transport. See sales conditions
- Sondertransport. Siehe AGB

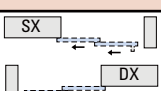
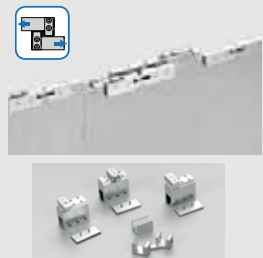
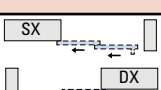
POS.	PROD.	ART.	MIS.	Q.TÀ	FIN.	EURO	FIN.	EURO	FIN.	EURO
A. 444		V-1821-P • Per fissaggio parete • For wall installation • Für Wandmontage	2000 mm	1 pc	AN	77,70 /pc	IXE	132,00 /pc		
			3000 mm	1 pc	AN	106,50 /pc	IXE	179,30 /pc		
			4000 mm	1 pc	AN	134,70 /pc	IXE	233,30 /pc		
			6000 mm	1 pc	AN	169,00 /pc	IXE	330,00 /pc		
		V-1821-P MIS	1500 → 3000 mm	1 pc	AN	168,00 /pc	IXE	240,00 /pc		
			3000 → 6000 mm	1 pc	AN	253,70 /pc	IXE	415,30 /pc		
<ul style="list-style-type: none"> • Velella vendibile solo con binario di pari lunghezza, se acquistata sciolta va calcolata una maggiorazione di € 30,00 per ogni imballo. • Cover profile available only packed with rail profile. For profiles supplied without rails the extra cost for each package unit is € 30,00. • Profilabdeckung lieferbar nur mit Laufschiene verpackt. Aufpreis für Profilabdeckungen ohne Laufschiene ist € 30,00 pro Verpackungseinheit 										
A. 445		V-1834	2000 mm	1 pc	AN	147,30 /pc	IXE	175,70 /pc		
			3000 mm	1 pc	AN	201,00 /pc	IXE	238,30 /pc		
			4000 mm	1 pc	AN	255,00 /pc	IXE	302,30 /pc		
			6000 mm	1 pc	AN	365,00 /pc	IXE	437,30 /pc		
		V-1834 MIS	1500 → 3000 mm	1 pc	AN	243,30 /pc	IXE	281,70 /pc		
			3000 → 6000 mm	1 pc	AN	433,30 /pc	IXE	505,30 /pc		
		IV-1820 	3000 mm	■ 4 pcs	AN	248,50 /pc 82,83 /m				
			6000 mm	■ 2 pcs	AN	495,50 /pc 82,58 /m				
		IV-1830 	3000 mm	■ 4 pc	AN	423,00 /pc 141,00 /m				
			6000 mm	■ 2 pcs	AN	848,50 /pc 141,42 /m				
		IV-1834 	3000 mm	■ 4 pcs	AN	167,00 /pc 55,67 /m	IXE	203,00 /pc 67,67 /m		
			6000 mm	■ 2 pcs	AN	309,70 /pc 51,62 /m	IXE	385,30 /pc 64,22 /m		
		IV-1821 	3000 mm	■ 4 pcs	AN	59,30 /pc 19,77 /m	IXE	90,50 /pc 30,17 /m		
			6000 mm	■ 2 pcs	AN	96,00 /pc 16,00 /m	IXE	169,30 /pc 28,22 /m		
									<ul style="list-style-type: none"> • Velella vendibile solo con binario di pari lunghezza, se acquistata sciolta va calcolata una maggiorazione di € 30,00 per ogni imballo. • Cover profile available only packed with rail profile. For profiles supplied without rails the extra cost for each package unit is € 30,00. • Profilabdeckung lieferbar nur mit Laufschiene verpackt. Aufpreis für Profilabdeckungen ohne Laufschiene ist € 30,00 pro Verpackungseinheit 	
		IV-1821-P 	3000 mm	■ 4 pcs	AN	65,00 /pc 21,67 /m	IXE	99,70 /pc 33,23 /m		
			6000 mm	■ 2 pcs	AN	105,50 /pc 17,58 /m	IXE	186,30 /pc 31,05 /m		
									<ul style="list-style-type: none"> • Velella vendibile solo con binario di pari lunghezza, se acquistata sciolta va calcolata una maggiorazione di € 30,00 per ogni imballo. • Cover profile available only packed with rail profile. For profiles supplied without rails the extra cost for each package unit is € 30,00. • Profilabdeckung lieferbar nur mit Laufschiene verpackt. Aufpreis für Profilabdeckungen ohne Laufschiene ist € 30,00 pro Verpackungseinheit 	
		TAGLIO-SCORR-UNI Costo per un taglio con misure uguali Cost for cut with same size Preis für einen Schnitt mit gleichen Maß				38,70 /pc				
		CLIPS-BRIXIA 	(2 pc / m)	■ 12 pcs		19,30 /set 1,61 /pc				
		MINIMO D'ORDINE: 2 profili da 6 mt o 4 profili da 3 mt. (o multipli), anche assortiti tra i vari modelli MINIMUM ORDER: No. 2 - 6 m profiles, or No. 4 - 3 m profiles, (or multiples), also in combination of different models. MINDESTBESTELLMENGE: 2 Profile mit 6 m oder 4 Profile mit 3 m (nur als Vielfaches), auch sortiert nach den verschiedenen Modellen.								

POS.	PROD.	ART.	MIS.	Q.TÀ	FIN.	EURO	FIN.	EURO	FIN.	EURO
A. 446	 <p>soft-close 100 Kg</p>	V-1823		1 set		358,00/set				
		V-1823		■ min 5 set		285,30/set				
A. 447	 <p>soft-close 100 Kg</p>	V-1833		1 set		561,30/set				
		V-1833		■ min 5 set		448,70/set				
A. 448		V-1826 DX/SX		1 set		460,30/set				
		V-1826 DX/SX		■ min 5 set		351,00/set				
			<ul style="list-style-type: none"> • Indicare sempre il senso di apertura • Please specify always opening direction • Bitte immer Öffnungsrichtung angeben 							
A. 449		V-1876 DX/SX		1 set	AN	183,30/set				
		V-1876 DX/SX		■ min 5 set		139,30/set				
			<ul style="list-style-type: none"> • Indicare sempre il senso di apertura • Please specify always opening direction • Bitte immer Öffnungsrichtung angeben 							
A. 450		V-1836 DX/SX		1 set		739,00/set				
		V-1836 DX/SX		■ min 5 set		590,00/set				
			<ul style="list-style-type: none"> • Indicare sempre il senso di apertura • Please specify always opening direction • Bitte immer Öffnungsrichtung angeben 							
A. 451		V-1886 DX/SX		1 set		360,00/set				
		V-1886 DX/SX		■ min 5 set		278,30/set				
			<ul style="list-style-type: none"> • Indicare sempre il senso di apertura • Please specify always opening direction • Bitte immer Öffnungsrichtung angeben 							
A. 452	 <p>soft-close 70 Kg OPTIONAL</p>	V-1824-70		1 pc	AN	93,00/pc				
		V-1824-70		■ min 5 pcs		80,30/pc				

POS.	PROD.	ART.	MIS.	Q.TÀ	FIN.	EURO	FIN.	EURO	FIN.	EURO	
A. 453	<p>soft-close 50 Kg</p> <p>OPTIONAL</p>	V-1824-50		1 pc		93,00 /pc					
		V-1824-50		■ min 5 pcs		80,30 /pc					
A. 454	<p>OPTIONAL</p> <p>• Apertura • Opening • Öffnung</p> <p>LAV-TEL-BRIXIA</p>			1 pc		112,70 /pc					
A. 455	<p>OPTIONAL</p> <p>VP-019-MT VP-018-MT VP-019-MT VP-019-MT</p> <p>VP-019-MT VP-018-MT</p>	VP-019-MT	1000 mm	1 pc		7,30 /pc					
			2000 mm	1 pc		5,30 /pc					
		VP-018-MT	1000 mm	1 pc		7,30 /pc					
			2000 mm	1 pc		5,30 /pc					
		VP-019-MT	3000 mm	1 pc		4,70 /pc					
			3000 mm	1 pc		4,70 /pc					
A. 456		V-1822	1 pc x 400 mm	1 pc		34,30 /pc					
		V-1822	1 pc x 400 mm	■ min 10 pcs		27,00 /pc					
A. 457		V-1837	1 pc x 400 mm	1 pc		44,30 /pc					
		V-1837	1 pc x 400 mm	■ min 10 pcs		32,50 /pc					
A. 458		V-1825	1 pc x 400 mm	1 pc		36,00 /pc					
		V-1825	1 pc x 400 mm	■ min 10 pcs		28,00 /pc					
A. 459		V-1835	1 pc x 400 mm	1 pc		45,70 /pc					
		V-1835	1 pc x 400 mm	■ min 10 pcs		33,50 /pc					
A. 460		V-1828-P		2 pc	AN	55,30 /set	IXE	65,30 /set			
		V-1828-P		■ min 5 set	AN	44,00 /set	IXE	52,30 /set			
A. 461		V-1828-S		2 pc	AN	55,30 /set	IXE	65,30 /set			
		V-1828-S		■ min 5 set	AN	44,00 /set	IXE	52,30 /set			
A. 462		V-1828-F		2 pc	AN	57,00 /set	IXE	68,50 /set			
		V-1828-F		■ min 5 set	AN	45,70 /set	IXE	54,70 /set			

POS.	PROD.	ART.	MIS.	Q.TÀ	FIN.	EURO	FIN.	EURO	FIN.	EURO
A. 463		V-1838-S		2 pc	AN	69,30/set	IXE	82,30/set		
		V-1838-S	■	min 5 set	AN	55,50/set	IXE	66,00/set		
A. 464		V-1838-P		2 pc	AN	65,00/set	IXE	77,70/set		
		V-1838-P	■	min 5 set	AN	52,30/set	IXE	62,30/set		
A. 465		V-1839		2 pc	AN	71,50/set	IXE	85,70/set		
		V-1839	■	min 5 set	AN	57,30/set	IXE	68,50/set		
A. 466		V-090		1 pc		59,00/pc				
		V-090	■	min 10 pcs		47,30/pc				
		V-090	■	min 20 pcs		40,70/pc				
A. 467		V-1817-A / V-1817-B / V-1817-C		1 set	A	33,50/set	B	33,50/set	C	33,50/set
		V-1817-A / V-1817-B / V-1817-C	■	min 5 set	A	27,00/set	B	27,00/set	C	27,00/set
A. 468		V-012		1 pc	AN	18,30/pc	NS	21,70/pc	CR	21,70/pc
		V-012	■	min 5 pcs	AN	12,50/pc	NS	15,70/pc	CR	15,70/pc
A. 469		V-099-C DX		1 pc	AN	60,00/pc				
		V-099-C DX	■	min 5 pcs	AN	38,00/pc				
		V-099-C SX		1 pc	AN	60,00/pc				
		V-099-C SX	■	min 5 pcs	AN	38,00/pc				
A. 470		V-1816		1 pc	AN	54,30/pc				
		V-1816	■	min 5 pcs		34,70/pc				
A. 471		V-2014-MIX	2000 mm	1 pc	AN	34,30/pc	IXE	47,30/pc	NO	44,30/pc
		V-2014-MIX	3000 mm	1 pc	AN	41,70/pc	IXE	62,30/pc	NO	54,30/pc
		V-2014-MIX	6000 mm	1 pc	AN	62,30/pc	IXE	103,50/pc	NO	81,00/pc
		MIX								
			<ul style="list-style-type: none"> • Minimo ordine 5 pezzi, anche assortiti, fra i vari profili e guarnizioni • Minimum order 5 pc also for combinations of various profiles and gaskets • Mindestbestellmenge 5 Stück, auch sortiert nach verschiedenen Profilen und Dichtungen 							

POS.	PROD.	ART.	MIS.	Q.TÀ	FIN.	EURO	FIN.	EURO	FIN.	EURO
		VP-018	3 mm	20 mt		38,50/pc 1,93 /m				
		VP-019	2 mm	20 mt		38,50/pc 1,93 /m				

Esempio prezzi al set ricavati da profili con imballo industriale (■) tagliati dal cliente
Example of set prices calculated with profiles in industrial packaging (■), cut by the customer
Beispiel: Set-Preise berechnet mit industriell/verpackten Profile (■), Schnitt bauseitig

PROFILI PROFILES PROFILE	KIT COMPONENTI COMPONENTS KIT EINZELTEILE KIT	SET SOFT-CLOSE SOFT-CLOSE SET SET SOFT-CLOSE	TAPPI+ GUIDA ENDCAPS+GUIDE ENDKAPPEN+FUHRUNG
<p>IV-1820 + IV-1821 + clips</p> <p>€ 101,8 / m</p>	<p>V-1823 100 Kg</p> <p>€ 285,30</p>	<p>V-1826</p> <p>€ 351,00</p>	<p>V-1824-70 70 Kg</p> <p>€ 80,30</p>
<p>IV-1820 + IV-1834 + IV-1821 + clips</p> <p>€ 153,42 / m</p>			
<p>IV-1830 + IV-1821 + clips</p> <p>€ 160,64 / m</p>	<p>V-1833 100 Kg</p> <p>€ 448,70</p>	<p>V-1836</p> <p>€ 590,00</p>	<p>V-1824-70 70 Kg</p> <p>€ 80,30</p>
<p>IV-1830 + IV-1834 + IV-1821 + clips</p> <p>€ 212,26 / m</p>			

POS.	PROD.	ART.	MIS.	Q.TÀ	FIN.	EURO	FIN.	EURO	FIN.	EURO	
INVISIBILE DOPPIO TELESCOPICO											
	V-7200		FINE SERIE END OF SERIES AUSLAUFMODELL							▲ SLIDING 130/131	
A. 472	<ul style="list-style-type: none"> Soffitto • Ceiling • Decke <p>V-7200 SET 1 FIX</p>	<p>V-7200 SET 1 MIS </p>	2000 mm	1 set	AN	1081,30/set					
			3000 mm	1 set	AN	1240,70/set					
			4000 mm	1 set	AN	1425,30/set					
			1500 → 3000 mm	1 set	AN	1389,70/set					
			3000 → 6000 mm	1 set	AN	1918,30/set					
A. 473	<ul style="list-style-type: none"> Parete • Wall • Wand <p>V-7200 SET 2 FIX</p>	<p>V-7200 SET 2 MIS </p>	3000 mm	1 set	AN	1417,30/set					
			4000 mm	1 set	AN	1677,50/set					
			6000 mm	1 set	AN	2091,50/set					
			1500 → 3000 mm	1 set	AN	1531,00/set					
			3000 → 6000 mm	1 set	AN	2259,00/set					
A. 474	<p>V-7200 SET 5 FIX</p>	<p>V-7200 SET 5 MIS </p>	2000 mm	1 set	AN	888,70/set					
			3000 mm	1 set	AN	1048,30/set					
			4000 mm	1 set	AN	1232,50/set					
			1500 → 3000 mm	1 set	AN	1174,00/set					
			3000 → 6000 mm	1 set	AN	1703,00/set					
V-7200 COMPONENTI / COMPONENTS / EINZELTEILE											
FINE SERIE END OF SERIES AUSLAUFMODELL											
A. 475	<p>V-7200</p>	<p>V-7200 MIS </p>	2000 mm	1 pc	AN	388,00/pc					
			3000 mm	1 pc	AN	547,30/pc					
			4000 mm	1 pc	AN	732,00/pc					
			6000 mm	1 pc	AN	1019,30/pc					
			1500 → 3000 mm	1 pc	AN	613,00/pc					
			3000 → 6000 mm	1 pc	AN	1141,70/pc					
A. 476	<p>V-7202</p>										
				1 set		469,30/set					

FIX

- Confezioni industriali
- Industrial packaging
- Industrieverpackungen
- Lunghezza fissa
- Fixed length
- Feste Länge

MIS

- Tagliato dal cliente
- Cut by installer
- Schnitt bauseitig

MIS

- Tagliato a misura del cliente
- Custom length
- Nach Mass geschnitten

- Confezioni profili con quantità fissa, disponibili solo in multipli della quantità indicata.
- Packs of profiles with fixed quantity, available only in multiples of the indicated quantity.
- Profilpackungen mit fixer Menge sind nur als Vielfaches der angeführten Menge erhältlich.

- Trasporto fuori standard. Vedi condizioni di vendita
- Non-standard transport. See sales conditions
- Sondertransport. Siehe AGB

POS.	PROD.	ART.	MIS.	Q.TÀ	FIN.	EURO	FIN.	EURO	FIN.	EURO
A. 477		V-7006-CF2	2000 mm	2 pcs	AN	128,00 / 2 pcs				
			3000 mm	2 pcs	AN	176,70 / 2 pcs				
			4000 mm	2 pcs	AN	225,30 / 2 pcs				
			6000 mm	2 pcs	AN	329,00 / 2 pcs				
<ul style="list-style-type: none"> • Veletta vendibile solo con binario di pari lunghezza, se acquistata sciolta va calcolata una maggiorazione di € 30,00 per ogni imballo. • Cover profile available only packed with rail profile. For profiles supplied without rails the extra cost for each package unit is € 30,00. • Profilabdeckung lieferbar nur mit Laufschiene verpackt. Aufpreis für Profilabdeckungen ohne Laufschienen ist € 30,00 pro Verpackungseinheit 										
A. 478		V-7206		1 set		225,30 / set				
A. 479		V-012-INS		1 pc	AN	32,50 / pc	NS	35,00 / pc	CR	37,50 / pc
A. 480		V-7005	1 pc x LB 400 mm	1 pc		32,00 / pc				
A. 481		V-7009	1 pc x LB 400 mm	1 pc		34,00 / pc				
A. 482		V-7201		2 pcs	AN	52,50 / set				
A. 483		<p>OPTIONAL</p> <p> 2 VP-019-MT</p> <p> 3 VP-018-MT</p>	1000 mm	1 pc		7,30 / pc				
			2000 mm	1 pc		5,30 / pc				
			3000 mm	1 pc		4,70 / pc				
			1000 mm	1 pc		7,30 / pc				
			2000 mm	1 pc		5,30 / pc				
			3000 mm	1 pc		4,70 / pc				



CF

- Prezzi speciali per l'acquisto delle quantità minime indicate (CF) dell'articolo. NB eventuali riordini o aggiunte per completamenti se di quantità inferiore alla minima, saranno fatturati al prezzo normale
- Special prices for the purchase of the minimum quantities indicated (CF) of the article. Note Well: any reorders or additions for completions of quantity less than the minimum will be invoiced at the normal price.
- Artikel mit Sonderpreisen bei Mindestabnahmemengen sind mit (CF) gekennzeichnet. Nachbestellungen oder Ergänzungen unter der Mindestabnahmemenge werden mit dem Normalpreis verrechnet.





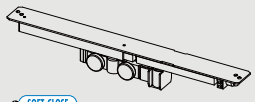



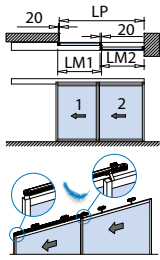

POS.	PROD.	ART.	MIS.	Q.TÀ	FIN.	EURO	FIN.	EURO	FIN.	EURO
INVISIBILE TELESCOPICO SINCRRO										
V-7300 <i>FINE SERIE END OF SERIES AUSLAUFMODELL</i> ▲ SLIDING 134/135										
A. 484	<p>• Soffitto • Ceiling • Decke</p> <p>V-7300 SET 1 MIS </p>		1500 → 3000 mm	1 set	AN	3499,50 /set				
A. 485	<p>• Parete • Wall • Wand</p> <p>V-7300 SET 2 MIS </p>		1500 → 3000 mm	1 set	AN	3790,00 /set				
V-7300 <i>FINE SERIE END OF SERIES AUSLAUFMODELL</i> ▲ SLIDING 136 <i>COMPONENTI / COMPONENTS / EINZELTEILE</i>										
A. 486	<p>V-7300</p>		2000 mm	1 pc	AN	667,00 /pc				
			3000 mm	1 pc	AN	906,70 /pc				
			4000 mm	1 pc	AN	1132,30 /pc				
			6000 mm	1 pc	AN	1636,30 /pc				
A. 487	<p>V-7202</p> <p>100 Kg</p>			1 set		469,30 /set				
A. 488	<p>V-7306</p>			1 set		1822,30 /set				

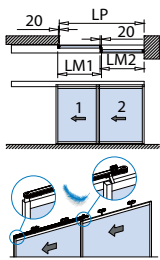
POS.	PROD.	ART.	MIS.	Q.TÀ	FIN.	EURO	FIN.	EURO	FIN.	EURO
A. 489		V-7307	Per vetro / For glass / Für Glass 12, 12,7, 13,7 mm	1 set		122,50/set				
A. 490		V-7305		1 pc		33,30/pc				
A. 491		 VP-019-MT		1000 mm	1 pc	7,30/pc				
				2000 mm	1 pc	5,30/pc				
				3000 mm	1 pc	4,70/pc				
			 VP-018-MT		1000 mm	1 pc	7,30/pc			
					2000 mm	1 pc	5,30/pc			
					3000 mm	1 pc	4,70/pc			

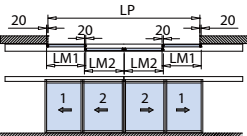
POS.	PROD.	ART.	MIS.	Q.TÀ	FIN.	EURO	FIN.	EURO	FIN.	EURO
EASY FRAME TELESCOPICO SINCRO (OPTIONAL SOFT-CLOSE)										
<div style="display: flex; justify-content: space-between; align-items: center;"> <div> <p>PO-220 SINCRO TRASCINAMENTO CON CINGHIA <i>SINCRO DRAGGING SYSTEM WITH TOOTHED BELT / SINCRO MITNEHMER KIT MIT ZAHNRIEMEN</i></p> </div> <div style="text-align: right;"> </div> <div style="text-align: right;"> <p>▲ SLIDING 138</p> </div> </div>										
A. 492	<p>• Soffitto • Ceiling • Decke</p>	<p>PO-220 SET 1 MIS </p>	1500 → 3500 mm	1 set	AN	4118,70/set				
A. 493	<p>• Parete • Wall • Wand</p>	<p>PO-220 SET 2 MIS </p>	1500 → 3500 mm	1 set	AN	4182,30/set				
A. 494	<p>• Soffitto • Ceiling • Decke</p>	<p>PO-220 SET 3 MIS </p>	3500 → 6000 mm	1 set	AN	7537,70/set				
A. 495	<p>• Parete • Wall • Wand</p>	<p>PO-220 SET 4 MIS </p>	3500 → 6000 mm	1 set	AN	7766,70/set				
<div style="display: flex; justify-content: space-between; align-items: center;"> <div> <p>PO-225 SINCRO TRASCINAMENTO CON CINGHIA <i>SINCRO DRAGGING SYSTEM WITH TOOTHED BELT / SINCRO MITNEHMER KIT MIT ZAHNRIEMEN</i></p> </div> <div style="text-align: right;"> </div> <div style="text-align: right;"> <p>▲ SLIDING 138</p> </div> </div>										
A. 496	<p>• Soffitto • Ceiling • Decke</p>	<p>PO-225 SET 1</p>	1500 → 4500 mm	1 set	AN	5695,00/set				
A. 497	<p>• Soffitto • Ceiling • Decke</p>	<p>PO-225 SET 3</p>	3500 → 6000 mm	1 set	AN	9866,30/set				

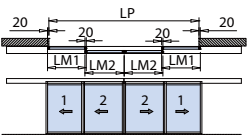
POS.	PROD.	ART.	MIS.	Q.TÀ	FIN.	EURO	FIN.	EURO	FIN.	EURO
A. 498	  OPTIONAL	PO-238		1 pc		314,30/pc				

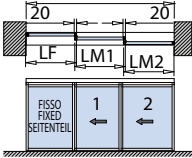
EASY FRAME TELESCOPICO (OPTIONAL SOFT-CLOSE)

PO-230 TRASCINAMENTO MECCANICO <i>MECHANICAL DRAGGING SYSTEM / MIT MECHANISCHEM MITNEHMER</i>				80 Kg		▲ SLIDING 139				
A. 499	<ul style="list-style-type: none"> Soffitto • Ceiling • Decke 	PO-230 SET 1 MIS 	1500 → 3500 mm	1 set	AN	3534,30/set				
A. 500	<ul style="list-style-type: none"> Parete • Wall • Wand 	PO-230 SET 2 MIS 	1500 → 3500 mm	1 set	AN	3597,70/set				
A. 501	<ul style="list-style-type: none"> Soffitto • Ceiling • Decke 	PO-230 SET 3 MIS 	3500 → 6000 mm	1 set	AN	6368,50/set				
A. 502	<ul style="list-style-type: none"> Parete • Wall • Wand 	PO-230 SET 4 MIS 	3500 → 6000 mm	1 set	AN	6597,00/set				
PO-235 TRASCINAMENTO MECCANICO <i>MECHANICAL DRAGGING SYSTEM / MIT MECHANISCHEM MITNEHMER</i>				80 Kg		▲ SLIDING 139				
A. 503	<ul style="list-style-type: none"> Soffitto • Ceiling • Decke 	PO-235 SET 1 MIS 	1500 → 4500 mm	1 set	AN	5110,30/set				

POS.	PROD.	ART.	MIS.	Q.TÀ	FIN.	EURO	FIN.	EURO	FIN.	EURO
A. 504	<p>• Soffitto • Ceiling • Decke</p>	PO-235 SET 3 MIS	3500 → 6000 mm	1 set	AN	8697,00/set				
A. 505		PO-238		1 pc		314,30/pc				
PO-220 / PO-225 / PO-230 / PO-235 COMPONENTI / COMPONENTS / EINZELTEILE										
A. 506		V-1630								
			2000 mm	1 pc	GR	515,50/pc				
			3000 mm	1 pc	GR	707,50/pc				
			4000 mm	1 pc	GR	900,50/pc				
			6000 mm	1 pc	GR	1215,00/pc				
A. 507		V-1632								
			2000 mm	1 pc	GR	158,50/pc				
			3000 mm	1 pc	GR	185,00/pc				
			4000 mm	1 pc	GR	213,30/pc				
			6000 mm	1 pc	GR	262,50/pc				
<ul style="list-style-type: none"> • Velella vendibile solo con binario di pari lunghezza, se acquistata sciolta va calcolata una maggiorazione di € 30,00 per ogni imballo. • Cover profile available only packed with rail profile. For profiles supplied without rails the extra cost for each package unit is € 30,00. • Profilabdeckung lieferbar nur mit Laufschiene verpackt. Aufpreis für Profilabdeckungen ohne Laufschienen ist € 30,00 pro Verpackungseinheit 										
A. 508		V-1634								
			2000 mm	1 pc	GR	222,00/pc				
			3000 mm	1 pc	GR	295,50/pc				
			4000 mm	1 pc	GR	369,30/pc				
			6000 mm	1 pc	GR	496,30/pc				
A. 509		PO-230 MIS	max LM 1200 mm x HM 3000 mm	1 set		865,00/set				

POS.	PROD.	ART.	MIS.	Q.TÀ	FIN.	EURO	FIN.	EURO	FIN.	EURO
A. 510		PO-231-FIX	max LM 1200 mm x HM 3000 mm	1 set		890,30/set				
A. 511		F-007		1 pair	AN	86,30/pair				
		F-007		■ min 5 pairs	AN	61,00/pair				
A. 512		PO-238		1 pc		314,30/pc				
A. 513		V-1638-P	<ul style="list-style-type: none"> • Parete • Wall • Wand 	2 pc	AN	54,30/set				
A. 514		V-1638-S	<ul style="list-style-type: none"> • Soffitto • Ceiling • Decke 	2 pc	AN	54,30/set				
A. 515		V-1635	1 pc x LB 400 mm	1 pc		36,00/pc				
A. 516		PO-232		1 set		151,30/set				
A. 517		PO-233		1 set		161,30/set				
A. 518		PO-226		1 set		1041,00/set				
A. 519		PO-236		1 set		399,70/set				















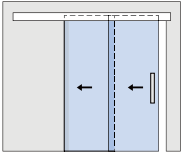

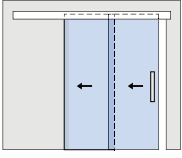
POS.	PROD.	ART.	MIS.	Q.TÀ	FIN.	EURO	FIN.	EURO	FIN.	EURO
A. 520		P-203 MIS		1 pc	AN	90,00/m				
		P-203 B	6000 mm	1 pc	AN	480,00/pc 80,00/m				
A. 521		SECTOR 4P IP-203	3000 mm	■ 4 pcs	AN	117,50/pc 39,17/m				
			6000 mm	■ 2 pcs	AN	227,30/pc 37,88/m				
		SECTOR 4P IP-203-VELETTA	3000 mm	■ 16 pcs	AN	52,00/pc 17,33/m				
			6000 mm	■ 8 pcs	AN	90,00/pc 15,00/m				
<p>• VeleTTa vendibile solo con binario di pari lunghezza, se acquistata sciolta va calcolata una maggiorazione di € 30,00 per ogni imballo. • Cover profile available only packed with rail profile. For profiles supplied without rails the extra cost for each package unit is € 30,00, • Profilabdeckung lieferbar nur mit Laufschiene verpackt. Aufpreis für Profilabdeckungen ohne Laufschiene ist € 30,00 pro Verpackungseinheit</p>										
<p>MINIMO D'ORDINE: 2 profili da 6 mt o 4 profili da 3 mt. (o multipli), anche assortiti tra i vari modelli MINIMUM ORDER: No. 2 - 6 m profiles, or No. 4 - 3 m profiles, (or multiples), also in combination of different models. MINDESTBESTELLMENGE: 2 Profile mit 6 m oder 4 Profile mit 3 m (nur als Vielfaches), auch sortiert nach den verschiedenen Modellen.</p>										
A. 522		P-202 MIS		1 pc	AN	81,70/m				
A. 523		P-202 B	6000 mm	1 pc	AN	411,00/pc 68,50/m				
		SECTOR 4P IP-202	3000 mm	■ 4 pcs	AN	147,30/pc 49,10/m				
			6000 mm	■ 2 pcs	AN	286,70/pc 47,78/m				
<p>MINIMO D'ORDINE: 2 profili da 6 mt o 4 profili da 3 mt. (o multipli), anche assortiti tra i vari modelli MINIMUM ORDER: No. 2 - 6 m profiles, or No. 4 - 3 m profiles, (or multiples), also in combination of different models. MINDESTBESTELLMENGE: 2 Profile mit 6 m oder 4 Profile mit 3 m (nur als Vielfaches), auch sortiert nach den verschiedenen Modellen.</p>										
A. 524		P-206		1 pc	AN	92,30/m				
		P-206 B	6000 mm	1 pc	AN	478,70/pc 79,78/m				
A. 525		P-F25		1 set		86,00/set				
		IP-F25		■ min 5 set		70,30/set				
A. 526		PO-212		1 pc		17,00/pc				





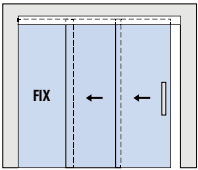

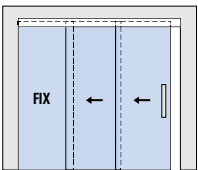
- Confezioni industriali
- Industrial packaging
- Industrieverpackungen

- MIS**
- Tagliato a misura del cliente
 - Custom length
 - Nach Mass geschnitten

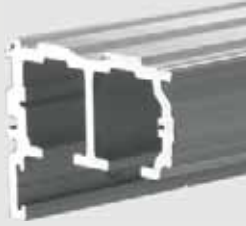
-
- Confezioni profili con quantità fissa, disponibili solo in multipli della quantità indicata.
 - Packs of profiles with fixed quantity, available only in multiples of the indicated quantity.
 - Profilpackungen mit fixer Menge sind nur als Vielfaches der angeführten Menge erhältlich.

-
- Trasporto fuori standard. Vedi condizioni di vendita
 - Non-standard transport. See sales conditions
 - Sondertransport. Siehe AGB

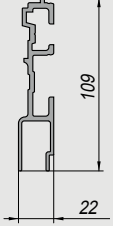
POS.	PROD.	ART.	MIS.	Q.TÀ	FIN.	EURO	FIN.	EURO	FIN.	EURO
TELESCOPICO SINCRO 2 VIE E 2 VIE + FISSO										
V-2200 SINCRO TRASCINAMENTO CON CINGHIA SINCRO DRAGGING SYSTEM WITH TOOTHED BELT / SINCRO MITNEHMER KIT MIT ZAHNRIEMEN    ▲ SLIDING 140										
 <ul style="list-style-type: none"> • Indicare sempre il senso di apertura • Please specify always opening direction • Bitte immer Öffnungsrichtung angeben 										
A. 527		V-2200 SET 1 MIS 	1500 → 3500 mm	1 set	AN	2823,30 /set				
A. 528		V-2200 SET 2 MIS 	1500 → 3500 mm	1 set	AN	2602,00 /set				
V-2250 SINCRO TRASCINAMENTO CON CINGHIA SINCRO DRAGGING SYSTEM WITH TOOTHED BELT / SINCRO MITNEHMER KIT MIT ZAHNRIEMEN    ▲ SLIDING 141										
 <ul style="list-style-type: none"> • Indicare sempre il senso di apertura • Please specify always opening direction • Bitte immer Öffnungsrichtung angeben 										
A. 529		V-2250 SET 1 MIS 	1500 → 3500 mm	1 set	AN	3133,70 /set				
A. 530		V-2250 SET 2 MIS 	1500 → 3500 mm	1 set	AN	2913,70 /set				

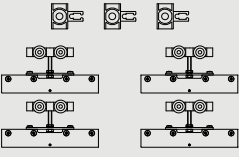
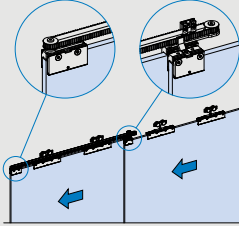
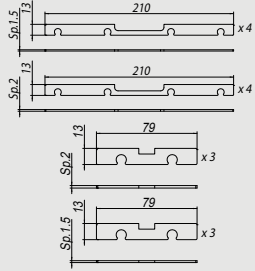



POS.	PROD.	ART.	MIS.	Q.TÀ	FIN.	EURO	FIN.	EURO	FIN.	EURO
V-2200 / V-2250 <i>COMPONENTI / COMPONENTS / EINZELTEILE</i>						▲ SLIDING 146/148				
A. 531		V-2200	2000 mm	1 pc	AN	469,70 /pc				
			3000 mm	1 pc	AN	633,50 /pc				
			4000 mm	1 pc	AN	798,00 /pc				
			 6000 mm	1 pc	AN	1084,70 /pc				
			1500 → 3000 mm	1 pc	AN	682,00 /pc				
			3000 → 6000 mm	1 pc	AN	1255,70 /pc				
A. 532		V-2101	2000 mm	1 pc	AN	220,00 /pc	IXE	275,00 /pc		
			3000 mm	1 pc	AN	245,70 /pc	IXE	306,70 /pc		
			4000 mm	1 pc	AN	272,50 /pc	IXE	340,30 /pc		
			 6000 mm	1 pc	AN	324,70 /pc	IXE	406,00 /pc		
			<ul style="list-style-type: none"> • Velella vendibile solo con binario di pari lunghezza, se acquistata sciolta va calcolata una maggiorazione di € 30,00 per ogni imballo. • Cover profile available only packed with rail profile. For profiles supplied without rails the extra cost for each package unit is € 30,00. • Profilabdeckung lieferbar nur mit Laufschiene verpackt. Aufpreis für Profilabdeckungen ohne Laufschiene ist € 30,00 pro Verpackungseinheit 							
A. 534		V-2104	2000 mm	1 pc	AN	186,70 /pc				
			3000 mm	1 pc	AN	267,70 /pc				
			4000 mm	1 pc	AN	381,30 /pc				
			 6000 mm	1 pc	AN	521,00 /pc				
			1500 → 3000 mm	1 pc	AN	308,00 /pc				
		V-2104 MIS 	3000 → 6000 mm	1 pc	AN	582,50 /pc				
A. 535		V-2203		1 set		723,50 /set				
A. 536		V-2206		1 set		942,30 /set				
A. 537		V-2207		1 set		90,00 /set				







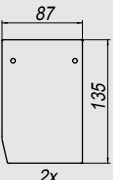
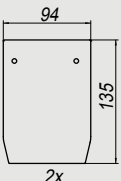
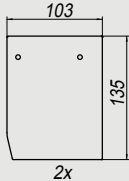
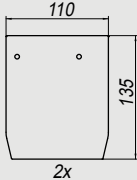
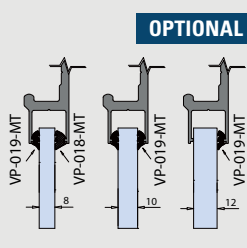







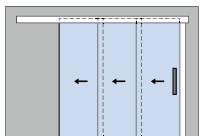

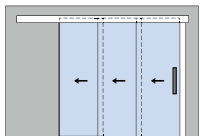
MIS 

- Tagliato a misura del cliente
- Custom length
- Nach Mass geschnitten

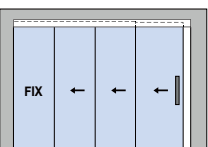

- Trasporto fuori standard. Vedi condizioni di vendita
- Non-standard transport. See sales conditions
- Sondertransport. Siehe AGB

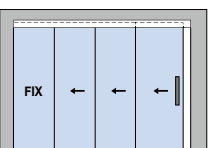
POS.	PROD.	ART.	MIS.	Q.TÀ	FIN.	EURO	FIN.	EURO	FIN.	EURO	
A. 538		V-2205	1 pc x LB 400 mm	1 pc		33,30/pc					
A. 539	 80 Kg OPTIONAL	V-2204		1 pc		321,30/pc					
A. 540		V-2208-P • Parete • Wall • Wand		2 pcs		63,30/set					
A. 541		V-2208-S • Soffitto • Ceiling • Decke		2 pcs		63,30/set					
A. 542		V-2209-P • Parete con V-2104 • Wall with V-2104 • Wand mit V-2104		2 pcs		63,30/set					
A. 543		V-2209-S • Soffitto con V-2104 • Ceiling with V-2104 • Decke mit V-2104		2 pcs		63,30/set					
A. 544		 VP-019-MT	1000 mm	1 pc		7,30/pc					
			2000 mm	1 pc		5,30/pc					
			3000 mm	1 pc		4,70/pc					
		 VP-018-MT	1000 mm	1 pc		7,30/pc					
			2000 mm	1 pc		5,30/pc					
			3000 mm	1 pc		4,70/pc					

POS.	PROD.	ART.	MIS.	Q.TÀ	FIN.	EURO	FIN.	EURO	FIN.	EURO
TELESCOPICO SINCR0 3 VIE E 3 VIE + FISSO										
V-2300 SINCR0 TRASCINAMENTO CON CINGHIA <i>SINCR0 DRAGGING SYSTEM WITH TOOTHED BELT / SINCR0 MITNEHMER KIT MIT ZAHNRIEMEN</i>    ▲ SLIDING 142										
 <ul style="list-style-type: none"> • Indicare sempre il senso di apertura • Please specify always opening direction • Bitte immer Öffnungsrichtung angeben 										
A. 545		V-2300 SET 1 MIS 	1500 → 3500 mm	1 set	AN	4339,50/set				
A. 546		V-2300 SET 2 MIS 	1500 → 3500 mm	1 set	AN	4269,70/set				
V-2350 SINCR0 TRASCINAMENTO CON CINGHIA <i>SINCR0 DRAGGING SYSTEM WITH TOOTHED BELT / SINCR0 MITNEHMER KIT MIT ZAHNRIEMEN</i>    ▲ SLIDING 143										
 <ul style="list-style-type: none"> • Indicare sempre il senso di apertura • Please specify always opening direction • Bitte immer Öffnungsrichtung angeben 										
A. 547		V-2350 SET 1 MIS 	1500 → 4500 mm	1 set	AN	4873,70/set				
A. 548		V-2350 SET 2 MIS 	1500 → 4500 mm	1 set	AN	4940,00/set				

MIS 

- Tagliato a misura del cliente
- Custom length
- Nach Mass geschnitten



- Trasporto fuori standard. Vedi condizioni di vendita
- Non-standard transport. See sales conditions
- Sondertransport. Siehe AGB

POS.	PROD.	ART.	MIS.	Q.TÀ	FIN.	EURO	FIN.	EURO	FIN.	EURO
V-2300 / V-2350 <i>COMPONENTI / COMPONENTS / EINZELTEILE</i>		▲ SLIDING 146/148								
A. 549		V-2300	2000 mm	1 pc	GR	575,30 /pc				
			3000 mm	1 pc	GR	716,30 /pc				
			4000 mm	1 pc	GR	857,30 /pc				
			6000 mm	1 pc	GR	1121,00 /pc				
			1500 → 3000 mm	1 pc	GR	803,50 /pc				
			3000 → 6000 mm	1 pc	GR	1255,70 /pc				
A. 550		V-2101	2000 mm	1 pc	AN	220,00 /pc	IXE	275,00 /pc		
			3000 mm	1 pc	AN	245,70 /pc	IXE	306,70 /pc		
			4000 mm	1 pc	AN	272,50 /pc	IXE	340,30 /pc		
			6000 mm	1 pc	AN	324,70 /pc	IXE	406,00 /pc		
			<ul style="list-style-type: none"> • Velella vendibile solo con binario di pari lunghezza, se acquistata sciolta va calcolata una maggiorazione di € 30,00 per ogni imballo. • Cover profile available only packed with rail profile. For profiles supplied without rails the extra cost for each package unit is € 30,00. • Profilabdeckung lieferbar nur mit Laufschiene verpackt. Aufpreis für Profilabdeckungen ohne Laufschiene ist € 30,00 pro Verpackungseinheit 							
A. 551		V-2104	2000 mm	1 pc	AN	186,70 /pc				
			3000 mm	1 pc	AN	267,70 /pc				
			4000 mm	1 pc	AN	381,30 /pc				
			6000 mm	1 pc	AN	521,00 /pc				
			V-2104 MIS	1500 → 3000 mm	1 pc	AN	308,00 /pc			
			3000 → 6000 mm	1 pc	AN	582,50 /pc				
A. 552		V-2303		1 set		1086,00 /set				
A. 553		V-2306		1 set		1807,00 /set				
A. 554		V-2307		1 set		135,70 /set				











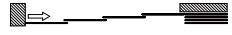
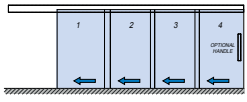
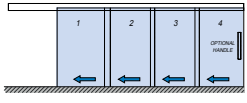

POS.	PROD.	ART.	MIS.	Q.TÀ	FIN.	EURO	FIN.	EURO	FIN.	EURO
A. 555		V-2205	1 pc x LB 400 mm	1 pc		33,30/pc				
A. 556	 OPTIONAL	V-2204		1 pc		321,30/pc				
A. 557	 2x	V-2308-P • Parete • Wall • Wand		2 pc		91,70/set				
A. 558	 2x	V-2308-S • Soffitto • Ceiling • Decke		2 pcs		91,70 set				
A. 559	 2x	V-2309-P • Parete con V-2104 • Wall with V-2104 • Wand mit V-2104		2 pcs		91,70 set				
A. 560	 2x	V-2309-S • Soffitto con V-2104 • Ceiling with V-2104 • Decke mit V-2104		2 pcs		91,70 set				
A. 561	 OPTIONAL			1000 mm	1 pc	7,30/pc				
			VP-019-MT	2000 mm	1 pc	5,30/pc				
				3000 mm	1 pc	4,70/pc				
				1000 mm	1 pc	7,30/pc				
			VP-018-MT	2000 mm	1 pc	5,30/pc				
				3000 mm	1 pc	4,70/pc				

MIS

- Tagliato a misura del cliente
- Custom length
- Nach Mass geschnitten

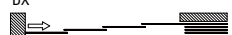
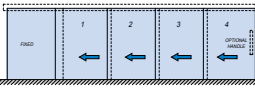
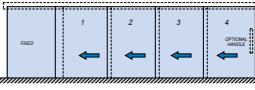
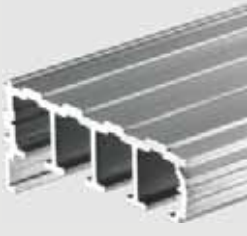

- Trasporto fuori standard. Vedi condizioni di vendita
- Non-standard trasport. See sales conditions
- Sondertransport. Siehe AGB

POS.	PROD.	ART.	MIS.	Q.TÀ	FIN.	EURO	FIN.	EURO	FIN.	EURO
TELESCOPICO SINCRO 4 VIE E 4 VIE + FISSO										
V-2400 SINCRO TRASCINAMENTO CON CINGHIA <i>SINCRO DRAGGING SYSTEM WITH TOOTHED BELT / SINCRO MITNEHMER KIT MIT ZAHNRIEMEN</i>    ▲ SLIDING 144										
	SX  DX 	<ul style="list-style-type: none"> • Indicare sempre il senso di apertura • Please specify always opening direction • Bitte immer Öffnungsrichtung angeben 								
A. 562	 V-2400 SET 1 MIS	1500 → 6000 mm	1 set	AN	5791,30 /set					
A. 563	 V-2400 SET 2 MIS	1500 → 6000 mm	1 set	AN	6127,00 /set					
V-2450 SINCRO TRASCINAMENTO CON CINGHIA <i>SINCRO DRAGGING SYSTEM WITH TOOTHED BELT / SINCRO MITNEHMER KIT MIT ZAHNRIEMEN</i>    ▲ SLIDING 145										
	SX  DX 	<ul style="list-style-type: none"> • Indicare sempre il senso di apertura • Please specify always opening direction • Bitte immer Öffnungsrichtung angeben 								
A. 564	 V-2450 SET 1 MIS	1500 → 6000 mm	1 set	AN	6305,00 /set					
A. 565	 V-2450 SET 2 MIS	1500 → 6000 mm	1 set	AN	6648,70 /set					
V-2400 / V-2450 <i>COMPONENTI / COMPONENTS / EINZELTEILE</i> ▲ SLIDING 146/148										
A. 566	 V-2400	2000 mm	1 pc	GR	644,30 /pc					
		3000 mm	1 pc	GR	859,50 /pc					
		4000 mm	1 pc	GR	1059,30 /pc					
		 6000 mm	1 pc	GR	1416,30 /pc					
A. 567	 V-2101	2000 mm	1 pc	AN	220,00 /pc	IXE	275,00 /pc			
		3000 mm	1 pc	AN	245,70 /pc	IXE	306,70 /pc			
		4000 mm	1 pc	AN	272,50 /pc	IXE	340,30 /pc			
		 6000 mm	1 pc	AN	324,70 /pc	IXE	406,00 /pc			
<ul style="list-style-type: none"> • Velella vendibile solo con binario di pari lunghezza, se acquistata sciolta va calcolata una maggiorazione di € 30,00 per ogni imballo. • Cover profile available only packed with rail profile. For profiles supplied without rails the extra cost for each package unit is € 30,00. • Profilabdeckung lieferbar nur mit Laufschiene verpackt. Aufpreis für Profilabdeckungen ohne Laufschiene ist € 30,00 pro Verpackungseinheit 										

POS.	PROD.	ART.	MIS.	Q.TÀ	FIN.	EURO	FIN.	EURO	FIN.	EURO
A. 568		V-2104	2000 mm	1 pc	AN	186,70/pc				
			3000 mm	1 pc	AN	267,70/pc				
			4000 mm	1 pc	AN	381,30/pc				
			6000 mm	1 pc	AN	521,00/pc				
			V-2104 MIS	1500 → 3000 mm	1 pc	AN	308,00/pc			
			3000 → 6000 mm	1 pc	AN	582,50/pc				
A. 569		V-2407		1 kit		181,00/kit				
A. 570		V-2406		1 kit		2281,50/kit				
A. 571		V-2403		1 set		1362,30/set				
A. 572		V-2405	1 pc x LB 400 mm	1 pc		44,00/pc				
A. 573		V-2204		1 pc		321,30/pc				
A. 574		V-2408-P	• Parete • Wall • Wand	2 pc		103,00/set				

FIX

- Lunghezza fissa
- Fixed length
- Feste Länge



- Tagliato dal cliente
- Cut by installer
- Schnitt bauseitig

MIS

- Tagliato a misura del cliente
- Custom length
- Nach Mass geschnitten



- Trasporto fuori standard. Vedi condizioni di vendita
- Non-standard transport. See sales conditions
- Sondertransport. Siehe AGB

POS.	PROD.	ART.	MIS.	Q.TÀ	FIN.	EURO	FIN.	EURO	FIN.	EURO
A. 575		V-2408-S • Soffitto • Ceiling • Decke		2 pcs		103,00 /set				
A. 576		V-2409-P • Parete con V-2104 • Wall with V-2104 • Wand mit V-2104		1 pc		103,00 /set				
A. 577		V-2409-S • Soffitto con V-2104 • Ceiling with V-2104 • Decke mit V-2104		1 pc		103,00 /set				
A. 578				1000 mm	1 pc	7,30 /pc				
				2000 mm	1 pc	5,30 /pc				
				3000 mm	1 pc	4,70 /pc				
				1000 mm	1 pc	7,30 /pc				
				2000 mm	1 pc	5,30 /pc				
				3000 mm	1 pc	4,70 /pc				
SOFFIETTINO										
L-2600							▲ SLIDING 150/151			
	<p>A Apertura a Sx/Left/Links B Apertura a Dx/Right/Rechts C Apertura a Sx/Left/Links D Apertura a Dx/Right/Rechts</p>									
A. 579		L-2600 SET 1 FIX		1000 mm	1 set	CP 843,30 /set	CR 854,50 /set	NS 894,50 /set		
				L-2600 SET 1 MIS	600 → 1200 mm	1 set	CP 905,30 /set	CR 914,00 /set	NS 903,00 /set	

POS.	PROD.	ART.	MIS.	Q.TÀ	FIN.	EURO	FIN.	EURO	FIN.	EURO
V-2600 COMPONENTI / COMPONENTS / EINZELTEILE ▲ SLIDING 151										
A. 580		L-217		1 pc	AN	132,00/pc	CR	175,70/pc		
		L-217 MIS 	600 → 1200 mm	1 pc	AN	184,50/pc	CR	253,70/pc		
A. 581		V-709		1 pc	CP	81,70/pc	NS	80,30/pc	CR	86,30/pc
A. 582		L-220		1 pc	CP	257,30/pc	NS	257,30/pc	CR	257,30/pc
A. 583		L-219		1 pc		65,00/pc				
L-2650  35 Kg ▲ SLIDING 152/153										
<div style="display: flex; justify-content: space-around;"> <div style="border: 1px solid black; padding: 5px; width: 20%;"> <p>A</p>  <p>Apertura a Sx/Left/Links</p> </div> <div style="border: 1px solid black; padding: 5px; width: 20%;"> <p>B</p>  <p>Apertura a Dx/Right/Rechts</p> </div> <div style="border: 1px solid black; padding: 5px; width: 20%;"> <p>C</p>  <p>Apertura a Sx/Left/Links</p> </div> <div style="border: 1px solid black; padding: 5px; width: 20%;"> <p>D</p>  <p>Apertura a Dx/Right/Rechts</p> </div> </div>										
A. 584		L-2650 SET 1 FIX		1000 mm	1 set	CR	619,50/set	NS	619,50/set	
		L-2650 SET 1 MIS 	600 → 1200 mm	1 set	CR	697,30/set	NS	697,30/set		

- Confezioni industriali
- Industrial packaging
- Industrieverpackungen

- FIX**
- Lunghezza fissa
 - Fixed length
 - Feste Länge

-  **MIS**
- Tagliato dal cliente
 - Cut by installer
 - Schnitt bauseitig

- MIS** 
- Tagliato a misura del cliente
 - Custom length
 - Nach Mass geschnitten

POS.	PROD.	ART.	MIS.	Q.TÀ	FIN.	EURO	FIN.	EURO	FIN.	EURO
V-2650 COMPONENTI / COMPONENTS / EINZELTEILE ▲ SLIDING 153										
A. 585		L-217		1 pc	AN	132,00 /pc	CR	175,70 /pc		
		L-217 MIS 	600 → 1200 mm	1 pc	AN	184,50 /pc	CR	253,70 /pc		
A. 586		B-502 SX-S		1 pc			CR	98,30 /pc	NS	98,30 /pc
		B-502 DX-S		1 pc						
A. 587		B-501 SX-S		1 pc			CR	92,70 /pc	NS	92,70 /pc
		B-501 DX-S		1 pc						
A. 588		L-219		1 pc		65,00 /pc				

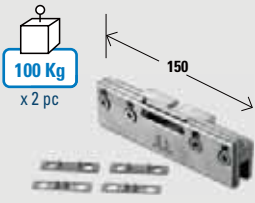
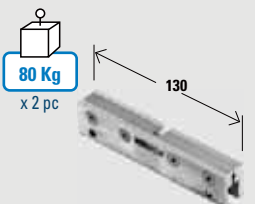
POS.	PROD.	ART.	MIS.	Q.TÀ	FIN.	EURO	FIN.	EURO	FIN.	EURO
PINZE CLAMPS / KLEMMSCHUHE										
PINZE SENZA LAVORAZIONE DEL VETRO CLAMPS WITHOUT GLASS PREPARATION / KLEMMSCHUHE OHNE GLASBEARBEITUNG ▲ SLIDING 158/159										
A. 589		V-108		1 pc		52,30 /pc				
		V-108		■ min 10 pcs		40,70 /pc				
				■ min 50 pcs		34,70 /pc				
A. 590		V-104		1 pc		52,30 /pc				
		V-104		■ min 10 pcs		40,70 /pc				
				■ min 50 pcs		34,70 /pc				

CF

- Prezzi speciali per l'acquisto delle quantità minime indicate (CF) dell'articolo. NB eventuali riordini o aggiunte per completamenti se di quantità inferiore alla minima, saranno fatturati al prezzo normale
- Special prices for the purchase of the minimum quantities indicated (CF) of the article. Note Well: any reorders or additions for completions of quantity less than the minimum will be invoiced at the normal price.
- Artikel mit Sonderpreisen bei Mindestabnahmemengen sind mit (CF) gekennzeichnet. Nachbestellungen oder Ergänzungen unter der Mindestabnahmemenge werden mit dem Normalpreis verrechnet.

POS.	PROD.	ART.	MIS.	Q.TÀ	FIN.	EURO	FIN.	EURO	FIN.	EURO
A. 591		V-090		1 pc		59,00/pc				
		V-090		■ min 10 pcs		47,30/pc				
		V-090		■ min 20 pcs		40,70/pc				
A. 592		V-1817-A / V-1817-B / V-1817-C		1 kit	A	33,50/set	B	33,50/set	C	33,50/set
		V-1817-A / V-1817-B / V-1817-C		■ min 10 set	A	27,00/set	B	27,00/set	C	27,00/set
		V-1817-A / V-1817-B / V-1817-C		■ min 10 set	A	27,00/set	B	27,00/set	C	27,00/set
A. 593		V-1845		1 pc		43,00/pc				
		V-1845		■ min 10 pcs		34,70/pc				
		V-1845		■ min 20 pcs		29,00/pc				
PINZE CON LAVORAZIONE DEL VETRO										▲ SLIDING 159/160
<i>CLAMPS WITH GLASS PREPARATION / KLEMMSCHUHE MIT GLASBEARBEITUNG</i>										
A. 594		V-011-FU		1 pc		33,50/pc				
		V-011-FU		■ min 10 pcs		28,00/pc				
		V-011-FU		■ min 20 pcs		25,50/pc				
A. 595		V-011-FR		1 pc		53,00/pc				
		V-011-FR		■ min 10 pcs		49,50/pc				
		V-011-FR		■ min 20 pcs		44,00/pc				
A. 596		V-006		1 pc		44,00/pc				
		V-006		■ min 10 pcs		34,70/pc				
		V-006		■ min 20 pcs		29,00/pc				

POS.	PROD.	ART.	MIS.	Q.TÀ	FIN.	EURO	FIN.	EURO	FIN.	EURO
A. 597		V-007		1 pc	AN	54,30/pc	NS	59,30/pc		
		V-007		■ min 10 pcs	AN	32,50/pc	NS	38,00/pc		
				■ min 20 pcs	AN	28,00/pc	NS	33,50/pc		
ALTRE PINZE OTHER CLAMPS / ANDERE KLEMMSCHUHE ▲ SLIDING 159/160										
A. 598		V-008		1 pc		65,30/pc				
A. 599		V-009		1 pc		59,00/pc				
A. 600		V-010		1 pc		84,30/pc				
SERRATURA CON NICCHIA E TIRANTE LOCK / SCHLÖSSER										
V-404 ▲ SLIDING 163										
A. 601	<ul style="list-style-type: none"> • Leva • Lever • Griff • WC apertura emergenza • WC emergency open • WC Notöffnung 	V-404 PO-WC		1 pc	CP	241,50/pc	NS	239,00/pc	CR	252,00/pc
		V-404 PO-WC		■ min 10 pcs	AN	193,50/pc	NS	191,30/pc	CR	208,00/pc

CF

- Prezzi speciali per l'acquisto delle quantità minime indicate (CF) dell'articolo. NB eventuali riordini o aggiunte per completamenti se di quantità inferiore alla minima, saranno fatturati al prezzo normale
- Special prices for the purchase of the minimum quantities indicated (CF) of the article. Note Well: any reorders or additions for completions of quantity less than the minimum will be invoiced at the normal price.
- Artikel mit Sonderpreisen bei Mindestabnahmemengen sind mit (CF) gekennzeichnet. Nachbestellungen oder Ergänzungen unter der Mindestabnahmemenge werden mit dem Normalpreis verrechnet.

POS.	PROD.	ART.	MIS.	Q.TÀ	FIN.	EURO	FIN.	EURO	FIN.	EURO
A. 602	<ul style="list-style-type: none"> • Leva • Lever • Griff 	V-404 PO-PO		1 pc	CP	243,50/pc	NS	241,50/pc	CR	254,50/pc
		V-404 PO-PO		■ min 10 pcs	AN	199,00/pc	NS	196,70/pc	CR	213,30/pc
A. 603	<ul style="list-style-type: none"> • WC indicatore colorato • WC coloured indicator • WC Schliessanzeige • Leva • Lever • Griff 	V-404 WC COLOUR		1 pc	CP	297,70/pc	NS	293,70/pc	CR	303,70/pc
		V-404 WC COLOUR		■ min 10 pcs	AN	238,30/pc	NS	235,50/pc	CR	251,00/pc
A. 604	<ul style="list-style-type: none"> • Tappo cieco • Blind • Blind • Leva • Lever • Griff 	V-404 PO-2FLG		1 pc	CP	301,30/pc	NS	297,50/pc	CR	315,30/pc
		V-404 PO-2FLG-CF10		■ min 10 pc	AN	251,00/pc	NS	247,30/pc	CR	264,00/pc
A. 605	<ul style="list-style-type: none"> • Tappo cieco • Blind • Blind • Tappo cieco • Blind • Blind 	V-404 2FLG		1 pc	CP	301,30/pc	NS	297,50/pc	CR	315,30/pc
		V-404 2FLG-CF10		■ min 10 pc	AN	251,00/pc	NS	247,30/pc	CR	264,00/pc
A. 606		V-404-SP12		2 pc		27,30/set				

POS.	PROD.	ART.	MIS.	Q.TÀ	FIN.	EURO	FIN.	EURO	FIN.	EURO
NICCHIE PER SCORREVOLI ▲ SLIDING 162/169 <i>SLIDING HANDLES / GRIFFMUSCHELN</i>										
A. 607		V-506		1 pair	CS	86,00/pair	NS	88,70/pair	CR	93,70/pair
					CP	88,70/pair	GR	76,00/pair		
		V-506-CF10		■ min 10 pairs	CS	66,30/pair	NS	69,30/pair	CR	77,50/pair
					CP	69,30/pc	GR	55,30/pc		
A. 608		V-406		1 pair	NS	97,00/pair	CR	98,00/pair	CP	94,50/pair
		V-406-CF10		■ min 10 pairs	NS	83,00/pair	CR	87,30/pair	CP	81,00/pair
A. 609		V-406-R		1 pair	AN	94,50/pair	NS	97,00/pair	GR	90,00/pair
		V-406-R-CF10		■ min 10 pairs	AN	81,00/pair	NS	83,00/pair	GR	78,50/pair
A. 610		V-522		1 pair	AN	75,00/pair	NS	76,00/pair	CR	91,50/pair
		V-522-CF10		■ min 10 pairs	AN	55,70/pair	NS	57,00/pair	CR	81,00/pair
A. 611		V-522-INC		1 pc	AN	51,00/pc	NS	52,30/pc		
		V-522-INC-CF10		■ min 10 pc	AN	36,00/pc	NS	37,00/pc		
A. 612		V-533-INC		1 pc	AN	46,70/pc	NS	47,70/pc		
		V-533-INC-CF10		■ min 10 pc	AN	32,00/pc	NS	33,00/pc		
A. 613		V-510		1 pair	CS	81,00/pair	NS	81,00/pair	CR	92,70/pair
					CP	81,00/pair				
		V-510-CF10		■ min 10 pairs	CS	66,30/pair	NS	66,30/pair	-	
					CP	66,30/pc				

CF





- Prezzi speciali per l'acquisto delle quantità minime indicate (CF) dell'articolo. NB eventuali riordini o aggiunte per completamenti se di quantità inferiore alla minima, saranno fatturati al prezzo normale
- Special prices for the purchase of the minimum quantities indicated (CF) of the article. Note Well: any reorders or additions for completions of quantity less than the minimum will be invoiced at the normal price.
- Artikel mit Sonderpreisen bei Mindestabnahmemengen sind mit (CF) gekennzeichnet. Nachbestellungen oder Ergänzungen unter der Mindestabnahmemenge werden mit dem Normalpreis verrechnet.

POS.	PROD.	ART.	MIS.	Q.TÀ	FIN.	EURO	FIN.	EURO	FIN.	EURO
A. 614	 60x90 mm	V-511		1 pair	CS	91,50/pair	NS	91,50/pair	CR	103,30/pair
					CP	91,50/pair	NO	100,30/pair		
		V-511		■ min 10 pairs	CS	83,00/pair	NS	83,00/pair		
					CP	83,00/pair	NO	91,50/pair		
A. 615	 60x110 mm	V-511-INC		1 pair	OL	143,30/pair				
A. 616	 60x100 mm	V-534-INC		1 pc	CS	74,00/pc	NS	74,00/pc	CR	76,00/pc
					OL	94,50/pc				
		V-534-INC		■ min 10 pcs	CS	56,50/pc	NS	56,50/pc	CR	59,00/pc
					OL	88,70/pc				
A. 617	 Ø50 mm	V-532-INC		1 pc	AN	40,30/pc	NS	41,50/pc		
		V-532-INC		■ min 10 pcs	AN	25,30/pc	NS	26,30/pc		
A. 618	 Ø64 mm	V-512-INC		1 pc	AN	45,30/pc	NS	46,30/pc		
		V-512-INC		■ min 10 pcs	AN	30,30/pc	NS	31,30/pc		
A. 619	 Ø65 mm	V-512		1 pair	AN	54,70/pair	CS	56,50/pair	NS	56,50/pair
					CR	70,30/pair	OL	107,50/pair	NO	87,30/pair
		V-512		■ min 10 pairs	AN	39,70/pair	CS	41,50/pair	NS	41,50/pair
					CR	51,00/pair			NO	70,50/pair

POS.	PROD.	ART.	MIS.	Q.TÀ	FIN.	EURO	FIN.	EURO	FIN.	EURO
A. 620	 Ø55 mm	V-523		1 pair	AN	63,30/pair	NS	79,50/pair	CR	110,00/pair
A. 621	 Ø59 mm	V-524		1 pair	CP	60,00/pair	NS	60,00/pair	CR	55,70/pair
		V-524		■ min 10 pairs	CP	47,50/pair	NS	47,50/pair	CR	44,70/pair
A. 622	 Ø40 mm	V-525		1 pair	AN	54,70/pair	NS	54,30/pair	CR	52,50/pair
		V-525		■ min 10 pairs	AN	42,50/pair	NS	42,00/pair	CR	40,30/pair
A. 623	 Ø40 mm	V-526		1 pair	AN	56,50/pair	NS	55,70/pair	CR	54,30/pair
		V-526		■ min 10 pairs	AN	44,00/pair	NS	43,50/pair	CR	42,00/pair
A. 624	 Ø30 mm	V-527		1 pair	AN	45,30/pair	NS	50,00/pair	CR	50,00/pair
A. 625	 Ø30 mm	V-528		1 pair	AN	45,30/pair	NS	50,70/pair	CR	50,70/pair
A. 626	 FINE SERIE END OF SERIES AUSLAUFMODELL.	B-179		1 pc	CS	88,00/pc	CR	88,00/pc		
		B-180		1 pc	CS	64,50/pc	CR	64,50/pc		

CF

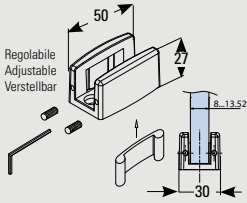
- Prezzi speciali per l'acquisto delle quantità minime indicate (CF) dell'articolo. NB eventuali riordini o aggiunte per completamenti se di quantità inferiore alla minima, saranno fatturati al prezzo normale
- Special prices for the purchase of the minimum quantities indicated (CF) of the article. Note Well: any reorders or additions for completions of quantity less than the minimum will be invoiced at the normal price.
- Artikel mit Sonderpreisen bei Mindestabnahmemengen sind mit (CF) gekennzeichnet. Nachbestellungen oder Ergänzungen unter der Mindestabnahmemenge werden mit dem Normalpreis verrechnet.

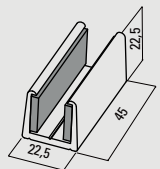
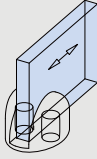
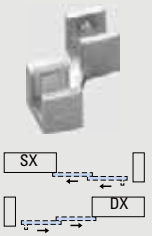
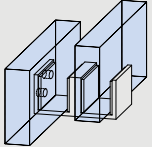
POS.	PROD.	ART.	MIS.	Q.TÀ	FIN.	EURO	FIN.	EURO	FIN.	EURO
GUIDE A PAVIMENTO FLOOR GUIDES / BODENFÜHRUNG ▲ SLIDING 174/175										
A. 627		V-012		1 pc	AN	18,30/pc	NS	21,70/pc	CR	21,70/pc
		V-012	■	min 5 pcs	AN	12,50/pc	NS	15,70/pc	CR	15,70/pc
A. 628		V-012-EVO		1 pc	AN	23,70/pc	NS	28,30/pc	CR	31,30/pc
		V-012-EVO	■	min 5 pcs	NO	28,30/pc				
		V-012-EVO		1 pc	AN	19,00/pc	NS	22,30/pc	CR	27,00/pc
		V-012-EVO	■	min 5 pcs	NO	22,30/pc				
A. 629		V-012-REG		1 pc	AN	28,00/pc	NS	30,50/pc	CR	33,30/pc
		V-012-REG	■	min 5 pcs	AN	22,30/pc	NS	24,70/pc	CR	27,00/pc
A. 630		V-012-INS		1 pc	AN	32,50/pc	NS	35,00/pc	CR	37,50/pc
		V-012-INS	■	min 5 pcs	AN	26,00/pc	NS	28,00/pc	CR	30,00/pc
A. 631		V-052		1 pc	AN	24,50/pc	NS	29,00/pc		
A. 632		V-014		1 pc	CS	42,00/pc	NS	42,00/pc	CR	42,00/pc
		V-014		1 pc	OL	42,00/pc	CP	42,00/pc		
A. 633		V-099-C DX		1 pc	AN	60,00/pc				
		V-099-C DX	■	min 5 pcs	AN	38,00/pc				
		V-099-C SX		1 pc	AN	60,00/pc				
		V-099-C SX	■	min 5 pcs	AN	38,00/pc				
A. 634		V-099		1 pc	AN	59,30/pc				

POS.	PROD.	ART.	MIS.	Q.TÀ	FIN.	EURO	FIN.	EURO	FIN.	EURO	
A. 635		V-099-B		1 pc	AN	59,30/pc					
A. 636		V-012-B		1 pc	AN	18,30/pc					
A. 637		L-116		1 pc	AN	56,50/m					
A. 638		PF-08		1 pc		22,00/pc					
		PF-08		■ min 5 pcs		17,00/pc					
A. 639		V-053		1 pc		28,30/pc					
ACCESSORI ACCESSORIES ZUBEHÖRE										▲ SLIDING 176/177	
A. 640		V-2014-MIX		2000 mm	1 pc	AN	34,30/pc	IXE	47,30/pc	NO	44,30/pc
				3000 mm	1 pc	AN	41,70/pc	IXE	62,30/pc	NO	54,30/pc
				6000 mm	1 pc	AN	62,30/pc	IXE	103,50/pc	NO	81,00/pc
			MIX	<ul style="list-style-type: none"> • Minimo ordine 5 pezzi, anche assortiti, fra i vari profili e guarnizioni • Minimum order 5 pc also for combinations of various profiles and gaskets • Mindestbestellmenge 5 Stück, auch sortiert nach verschiedenen Profilen und Dichtungen 							
		V-2014-1500	1500	1 pc	AN	22,70	IXE	34,30	NO	30,00	
		V-2014-3000	3000	1 pc	AN	46,00	IXE	68,50	NO	59,70	
		<ul style="list-style-type: none"> • 1 pc da 1500 mm o 3000 mm acquistabile solo con sistema scorrevole • 1 pc of 1500 mm or 3000 mm purchasable just with sliding system • 1 Stück 1500 mm oder 3000 mm nur mit Schiebetürsystem käuflich 									
		VP-018	3 mm	20 mt		38,50					
		VP-019	2 mm	20 mt		38,50					

POS.	PROD.	ART.	MIS.	Q.TÀ	FIN.	EURO	FIN.	EURO	FIN.	EURO
A. 641		V-2015-MIX	2000 mm	1 pc	AN	40,00/pc	IXE	53,00/pc		
			3000 mm	1 pc	AN	49,30/pc	IXE	68,50/pc		
			6000 mm	1 pc	AN	71,50/pc	IXE	110,30/pc		
			MIX <ul style="list-style-type: none"> • Minimo ordine 5 pezzi, anche assortiti, fra i vari profili e guarnizioni • Minimum order 5 pc also for combinations of various profiles and gaskets • Mindestbestellmenge 5 Stück, auch sortiert nach verschiedenen Profilen und Dichtungen 							
		VP-019	2 mm	20 mt		38,50				
A. 642		V-039	3000 mm	1 pc		43,30/pc				
		V-039-MIX	3000 mm	1 pc		30,50/pc				
		MIX <ul style="list-style-type: none"> • Minimo ordine 10 pezzi, anche assortiti, fra i vari profili e guarnizioni • Minimum order 10 pc also for combinations of various profiles and gaskets • Mindestbestellmenge 10 Stück, auch sortiert nach verschiedenen Profilen und Dichtungen 								
A. 643		V-040/13	13 x 3000 mm	1 pc		43,30/pc				
		V-040/18	18 x 3000 mm	1 pc		43,30/pc				
		V-040/21	21 x 3000 mm	1 pc		43,30/pc				
		V-040-MIX	3000 mm	1 pc		30,50/pc				
		MIX <ul style="list-style-type: none"> • Minimo ordine 10 pezzi, anche assortiti, fra i vari profili e guarnizioni • Minimum order 10 pc also for combinations of various profiles and gaskets • Mindestbestellmenge 10 Stück, auch sortiert nach verschiedenen Profilen und Dichtungen 								
A. 644		V-041		1 pc		43,30/pc				
		V-041-MIX		1 pc		30,50/pc				
		MIX <ul style="list-style-type: none"> • Minimo ordine 10 pezzi, anche assortiti, fra i vari profili e guarnizioni • Minimum order 10 pc also for combinations of various profiles and gaskets • Mindestbestellmenge 10 Stück, auch sortiert nach verschiedenen Profilen und Dichtungen 								



- Trasporto fuori standard. Vedi condizioni di vendita
- Non-standard transport. See sales conditions
- Sondertransport. Siehe AGB

POS.	PROD.	ART.	MIS.	Q.TÀ	FIN.	EURO	FIN.	EURO	FIN.	EURO
		V-040-REG		3000 mm	1 pc					
A. 645		WRU-M 80/50 MT5		5 mt						
A. 646.1		WRU-C-BUMP-MT12		12 mt						
A. 648	<p>Setola Brush seal Bürstendichtung L = 15 mm</p>	P-013-MIX	3000 mm	1 pc	AN					
		MIX								
		<ul style="list-style-type: none"> • Minimo ordine 5 pezzi, anche assortiti, fra i vari profili e guarnizioni • Minimum order 5 pc also for combinations of various profiles and gaskets • Mindestbestellmenge 5 Stück, auch sortiert nach verschiedenen Profilen und Dichtungen 								
A. 649	<p>Setola Brush seal Bürstendichtung L = 15 mm</p>	P-014-MIX	3000 mm	1 pc	AN					
		MIX								
		<ul style="list-style-type: none"> • Minimo ordine 5 pezzi, anche assortiti, fra i vari profili e guarnizioni • Minimum order 5 pc also for combinations of various profiles and gaskets • Mindestbestellmenge 5 Stück, auch sortiert nach verschiedenen Profilen und Dichtungen 								

GUIDA TECNICA PER LA SCELTA DEL VOSTRO SISTEMA
TECHNICAL GUIDE FOR THE CHOICE OF YOUR SYSTEM
AUSWAHL VON DUSCHKABINEN NACH VORHANDENEN KRITERIEN

BOX DOCCIA CON SISTEMA SCORREVOLE
SHOWER BOX WITH SLIDING SYSTEM
DUSCHKABINEN MIT SCHIEBETÜRSYSTEM

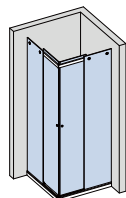

BX-4000 LINEA 30

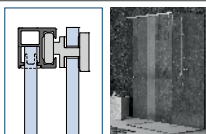

▶ 138

BX-6000 ETEREA

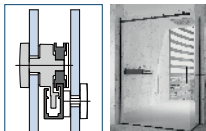

▶ 132

**BX-6020 ETEREA
SOFT-CLOSE**

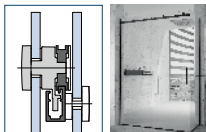

▶ 134

BX-1501

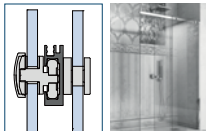

▶ 146

**BX-3100
(OPTIONAL SOFT-CLOSE)**

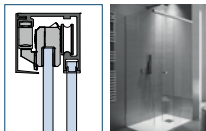

▶ 142

BX-2000

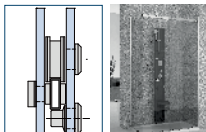

▶ 150

BX-01

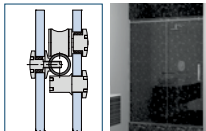

▶ 158

BX-02

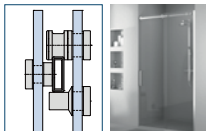

▶ 161

BOX DOCCIA SCORREVOLE A SOFFIETTO
SHOWER BOX WITH FOLDING DOOR
DUSCHKABINEN MIT SYSTEM FÜR FALTÜREN

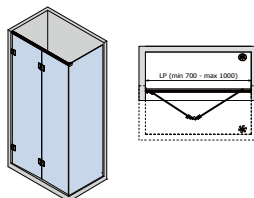

BX-2700

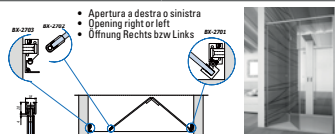

▶ 163

BX-2600

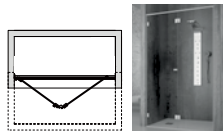

▶ 166

**BOX DOCCIA CON ANTA A BATTENTE
(CERNIERA A SCATTO)**
**SHOWER BOX WITH SWING DOOR
(DOUBLE ACTION CLICKING HINGES)**
**DUSCHKABINEN MIT DREH-TÜR
(SELBSTSCHLIESSENDE PENDELTÜRBÄNDER)**

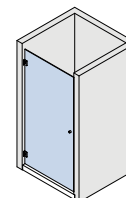

B-150



▶ 172

B-701



▶ 171

B-702



▶ 171

B-100 / B-101



▶ 171

B-102 / B-103



▶ 171-171

B-301



▶ 172

B-306



▶ 172

L-220



▶ 172

B-400 / B-401



▶ 172-173

B-402 / B-405



▶ 173-173

CERNIERE A SCATTO IN BATTUTA
SINGLE ACTION CLICKING HINGES
FOR CONTINUOUS SEALS

ANSCHLAGTÜRBÄNDER
FÜR DURCHGEHENDE DICHTUNG
(SELBSTSCHLIESSENDE BÄNDER)

B-201



▶ 173

B-202



▶ 173

CERNIERE CON ALZATA IN APERTURA
HINGES WITH LIFT-LOWER FUNCTION

BÄNDER MIT HEBE-SENK-FUNKTION

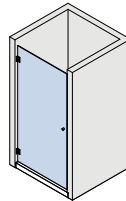

B-501 DX-SX



▶ 173

B-502 DX-SX



▶ 174

CERNIERE LIBERE IN BATTUTA
SINGLE ACTION HINGES
FOR CONTINUOUS SEALS

ANSCHLAGTÜRBÄNDER
FÜR DURCHGEHENDE DICHTUNG

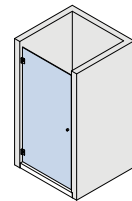

B-711



▶ 174

B-712



▶ 174

B-105



▶ 174

B-104



▶ 174

B-601 DX-SX



▶ 174

B-602 DX-SX



▶ 174

GUIDA TECNICA PER LA SCELTA DEL VOSTRO SISTEMA TECHNICAL GUIDE FOR THE CHOICE OF YOUR SYSTEM AUSWAHL VON DUSCHKABINEN NACH VORHANDENEN KRITERIEN

PIVOT ALTO-BASSO (BILICO)
PORTA BATTENTE
TOP/BOTTOM PIVOT HINGES
OBERE/UNTERE PIVOT BÄNDER

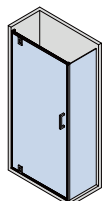

BX-2100



▶ 169

B-304



▶ 170

B-305



▶ 171

B-303 DX-SX



▶ 172

PROFILI
PROFILES
PROFILE

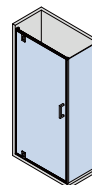

PROFILI DI BATTUTA
DOOR STOP PROFILES
TÜRANSCHLAGSPROFIE

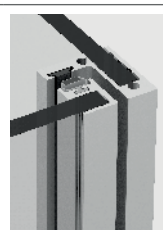

▶ 175

PROFILI GOCCIOLATOI
SPLASH GUARD PROFILES
SCHWALLSCHUTZPROFILE



▶ 176

GUIDE A PAVIMENTO
FLOOR GUIDES
BODENFÜHRUNGEN



▶ 157

CANALINE "U"
IN ALLUMINIO
U PROFILES IN ALUMINIUM
U-PROFILE AUS ALUMINIUM

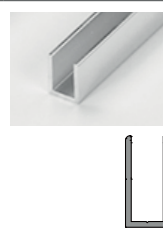

▶ 177

CANALINE "U" INOX
SPIGOLO VIVO
U PROFILES IN INOX
U-PROFILE AUS EDELSTAHL

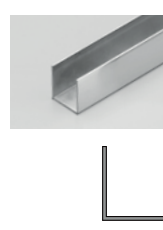

▶ 179

CANALINE "U"
BORDO RIPIEGATO
U PROFILES
WITH FOLDED EDGE
U-PROFILE MIT
ABGERUNDETER KANTE

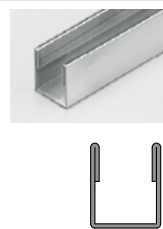

▶ 180

ANGOLARI
L PROFILES
L PROFILE

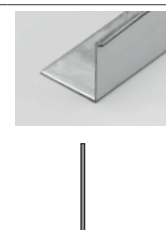

▶ 180

CANALINE
CON ALETTA LATERALE
U PROFILES
WITH SIDE PLATE
U-PROFILE
MIT SEITLICHER PLATTE

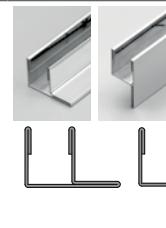

▶ 181

SEPARÉ
SEPARÉ
SEPARÉ

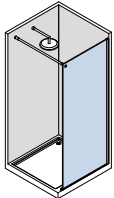

**BARRE DI SUPPORTO
QUADRE REGOLABILI**
**ADJUSTABLE SQUARE
SUPPORT BARS**
**VERSTELBARE ECKIGE
STABILISATIONSSTANGEN**



▶ 182

**BARRE DI SUPPORTO
QUADRE**
SQUARE SUPPORT BARS
**ECKIGE
STABILISATIONSSTANGEN**



▶ 184

BARRE DI SUPPORTO TONDE
ROUND SUPPORT BARS
**RUNDE
STABILISATIONSSTANGEN**



▶ 185

ACCESSORI
ACCESSORIES
ZUBEHÖRE

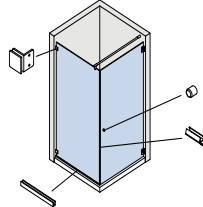

MORSETTI
CLAMPS
KLEMMBESCHLÄGE



▶ 193

RAGNETTI
CONNECTORS
VERBINDER



▶ 193

GUARNIZIONI
GASKETS
DICHTUNGEN



▶ 196

**POMOLI, NICCHIE E
MANIGLIONI**
**KNOBS, SLIDING
HANDLES, PULLHANDLES**
**KNÖPFE,
GRIFFMUSCHELN,
STOSSGRIFFE**



▶ 187

POS.	PROD.	ART.	MIS.	Q.TÀ	FIN.	EURO	FIN.	EURO
BX-6000 ETEREA						▶ BOX DOCCIA 18/29		
B.1		BX-6000 SET 1	1000x1000 mm	1 set	CR	947,50 /set	NO	1047,00 /set
		BX-6000 SET 1 ⚠	3000 mm	■ min 5 set	CR	827,00 ^/set		
		BX-6000 SET 1 ⚠	3000 mm	■ min 10 set	CR	773,00 ^/set		
		BX-PT-01 SET1		1 set	CR	181,00 /set	NO	199,30 /set
		BX-PT-01 SET1 ■ Industrial packaging ▶ 156						
	B.2		BX-6000 SET 2 DX BX-6000 SET 2 SX	1500 mm	1 set	CR	511,50 /set	NO
BX-6000-3 SET 2 DX BX-6000-3 SET 2 SX			3000 mm	1 set	CR	561,00 /set	NO	612,70 /set
BX-6000 SET2 ⚠			1500 mm	■ min 5 set	CR	442,00 */set		
BX-6000 SET2 ⚠			1500 mm	■ min 10 set	CR	412,00 */set		
BX-6000-3 SET2 ⚠			3000 mm	■ min 5 set	CR	503,00 /set		
BX-6000-3 SET2 ⚠			3000 mm	■ min 10 set	CR	467,00 /set		
		BX-PT-01 SET2	1500 mm	1 set	CR	112,00 /set	NO	119,50 /set
		BX-PT-01 SET2 3M	3000 mm	1 set	CR	163,00 /set	NO	182,00 /set
		BX-PT-01 SET2 ■ Industrial packaging ▶ 156						
B.3		BX-6000 SET 3 DX BX-6000 SET 3 SX	1500 mm	1 set	CR	641,30 /set	NO	738,50 /set
		BX-6000-3 SET 3 DX BX-6000-3 SET 3 SX	3000 mm	1 set	CR	690,70 /set	NO	776,50 /set
		BX-6000 SET3 ⚠	1500 mm	■ min 5 set	CR	557,00 */set		
		BX-6000 SET3 ⚠	1500 mm	■ min 10 set	CR	519,00 */set		
		BX-6000-3 SET3 ⚠	3000 mm	■ min 5 set	CR	618,00 /set		
		BX-6000-3 SET3 ⚠	3000 mm	■ min 10 set	CR	574,00 /set		
		BX-PT-01 SET3	1500 mm	1 set	CR	201,00 /set	NO	221,00 /set
		BX-PT-01 SET3 3M	3000 mm	1 set	CR	288,50 /set	NO	318,50 /set
	BX-PT-01 SET3 ■ Industrial packaging ▶ 156							

- Confezioni industriali
- Industrial packaging
- Industrieverpackungen

- ⚠ **ESEMPIO DI COSTO CON IMBALLO INDUSTRIALE.**
Confezioni profili con quantità fissa, disponibili solo in multipli della quantità indicata. Vedi pag. 136
- **EXAMPLE TOTAL COST WITH COMPONENTS IN INDUSTRIAL PACKAGING.** **Packs of profiles** with fixed quantity, available only in multiples of the indicated quantity. Page 136
- **BEISPIEL GESAMTPREIS MIT INDUSTRIELLER VERPACKUNG** **Profilpackungen** mit fixer Menge sind nur als Vielfaches der angeführten Menge erhältlich. Siehe Seite 136

■ **min**

- Prezzi speciali per l'acquisto delle quantità minime indicate (CF) dell'articolo. NB: eventuali riordini o aggiunte per completamenti se di quantità inferiore alla minima, saranno fatturati al prezzo normale
- Special prices for the purchase of the minimum quantities indicated (CF) of the article. Note Well: any reorders or additions for completions of quantity less than the minimum will be invoiced at the normal price.
- Artikel mit Sonderpreisen bei Mindestabnahmemengen sind mit (CF) gekennzeichnet. Nachbestellungen oder Ergänzungen unter der Mindestabnahmemenge werden mit dem Normalpreis verrechnet.

POS.	PROD.	ART.	MIS.	Q.TÀ	FIN.	EURO	FIN.	EURO
B. 4		BX-6000 SET 4 DX BX-6000 SET 4 SX	1500 mm	1 set	CR	548,50 /set	NO	622,70 /set
		BX-6000-3 SET 4 DX BX-6000-3 SET 4 SX	3000 mm	1 set	CR	597,70 /set	NO	660,50 /set
		BX-6000 SET4 ⚠	1500 mm	■ min 5 set	CR	474,00 */set		
		BX-6000 SET4 ⚠	1500 mm	■ min 10 set	CR	443,00 */set		
		BX-6000 SET4 ⚠	3000 mm	■ min 5 set	CR	535,00 /set		
		BX-6000 SET4 ⚠	3000 mm	■ min 10 set	CR	498,00 /set		
B. 5		BX-PT-01 SET4	1500 mm	1 set	CR	201,00 /set	NO	221,00 /set
		BX-PT-01 SET4 3M	3000 mm	1 set	CR	288,50 /set	NO	318,50 /set
		BX-PT-01 SET4 ■ Industrial packaging ▶ 156						
B. 5		BX-6000 SET 5 Profili a terra inclusi Floor profiles included Bodenprofile enthalten	3000 mm	1 set	CR	787,00 /set	NO	865,30 /set

BX-PT-01 ESEMPIO DI COSTO CON IMBALLO INDUSTRIALE
EXAMPLE TOTAL COST WITH COMPONENTS IN INDUSTRIAL PACKAGING
BEISPIEL GESAMTPREIS MIT INDUSTRIELLER VERPACKUNG

B. 6	PER/FOR/FÜR SET 1 SET 2 SET 3 SET 4	PER/FOR/FÜR SET 1 SET 2 SET 3 SET 4	PER/FOR/FÜR SET 1	PER/FOR/FÜR SET 2	PER/FOR/FÜR SET 3	PER/FOR/FÜR SET 4
BX-PT-C58-CF12 ⚠ 3000 mm	BX-PT-C56-CF8 ⚠ 3000 mm	PLAST-PT1-S1-MIX	PLAST-PT1-S2-MIX	PLAST-PT1-S3-MIX	PLAST-PT1-S4-MIX	
CR 45,53 */1 pcs 546,30 /12 pcs	CR 33,63 */1 pcs 269,00 /8 pcs	CR 52,00 /1 kit	CR 43,30 /1 kit	CR 46,00 /1 kit	CR 46,00 /1 kit	
NO 69,39 */1 pcs 832,70 /12 pcs	NO 47,84 */1 pcs 382,70 /8 pcs	NO 67,50 /1 kit	NO 56,50 /1 kit	NO 59,50 /1 kit	NO 59,50 /1 kit	

	BX-PT-01 SET 1	BX-PT-01 SET 2	BX-PT-01 SET 3	BX-PT-01 SET 4
3000 mm	CR 115,00 /set	CR 106,00 /set	CR 109,00 /set	CR 109,00 /set
1500 mm *	-	CR 80,00* /set	CR 109,00 /set	CR 109,00 /set

MIX

- Minimo ordine 5 pezzi, anche assortiti, fra i vari set
- Minimum order 5 pc also a mixture of different sets
- Mindestbestellmenge: 5 Stück sortiert



- Tagliato dal cliente a 45°
- Cut 45° by installer
- Schnitt 45° bauseitig



- Tagliato dal cliente
- Cut by installer
- Schnitt bauseitig

POS.	PROD.	ART.	MIS.	Q.TÀ	FIN.	EURO	FIN.	EURO	
		BX-6020 ETEREA SOFT-CLOSE							► BOX DOCCIA 18/29
B. 7		BX-6020 SET 1	1000x1000 mm	1 set	CR	1105,30 /set	NO	1212,30 /set	
		BX-6020 SET 1	3000 mm	■ min 5 set	CR	972,00 ^/set			
		BX-6020 SET 1	3000 mm	■ min 10 set	CR	924,00 ^/set			
		BX-PT-01 SET1			1 set	CR	181,00 /set	NO	199,30 /set
		BX-PT-01 SET1 ■ Industrial packaging ► 156							
	B. 8		BX-6020 SET 2	1500 mm	1 set	CR	591,00 /set	NO	657,30 /set
BX-6020-3 SET 2			3000 mm	1 set	CR	640,30 /set	NO	695,30 /set	
BX-6020 SET 2			1500 mm	■ min 5 set	CR	514,00 */set			
BX-6020 SET 2			1500 mm	■ min 10 set	CR	488,00 */set			
BX-6020-3 SET 2			3000 mm	■ min 5 set	CR	575,00 /set			
		BX-6020-3 SET 2	3000 mm	■ min 10 set	CR	543,00 /set			
		BX-PT-01 SET2	1500 mm	1 set	CR	112,00 /set	NO	119,50 /set	
		BX-PT-01 SET2 3M	3000 mm	1 set	CR	163,00 /set	NO	182,00 /set	
		BX-PT-01 SET2 ■ Industrial packaging ► 156							
B. 9		BX-6020 SET 3	1500 mm	1 set	CR	720,30 /set	NO	821,00 /set	
		BX-6020-3 SET 3	3000 mm	1 set	CR	769,70 /set	NO	859,00 /set	
		BX-6020 SET 3	1500 mm	■ min 5 set	CR	630,00 */set			
		BX-6020 SET 3	1500 mm	■ min 10 set	CR	594,00 */set			
		BX-6020-3 SET 3	3000 mm	■ min 5 set	CR	630,00 /set			
		BX-6020-3 SET 3	3000 mm	■ min 10 set	CR	594,00 /set			
		BX-PT-01 SET3	1500 mm	1 set	CR	201,00 /set	NO	221,00 /set	
		BX-PT-01 SET3 3M	3000 mm	1 set	CR	288,50 /set	NO	318,50 /set	
		BX-PT-01 SET3 ■ Industrial packaging ► 156							

- Confezioni industriali
- Industrial packaging
- Industrieverpackungen

- ESEMPIO DI COSTO CON IMBALLO INDUSTRIALE.**
Confezioni profili con quantità fissa, disponibili solo in multipli della quantità indicata. Vedi pag. 136
- EXAMPLE TOTAL COST WITH COMPONENTS IN INDUSTRIAL PACKAGING. Packs of profiles** with fixed quantity, available only in multiples of the indicated quantity. Page 136
- BEISPIEL GESAMTPREIS MIT INDUSTRIELLER VERPACKUNG**
Profilpackungen mit fixer Menge sind nur als Vielfaches der angeführten Menge erhältlich. Siehe Seite 136

■ **min**

- Prezzi speciali per l'acquisto delle quantità minime indicate (CF) dell'articolo. NB: eventuali riordini o aggiunte per completamenti se di quantità inferiore alla minima, saranno fatturati al prezzo normale
- Special prices for the purchase of the minimum quantities indicated (CF) of the article. Note Well: any reorders or additions for completions of quantity less than the minimum will be invoiced at the normal price.
- Artikel mit Sonderpreisen bei Mindestabnahmemengen sind mit (CF) gekennzeichnet. Nachbestellungen oder Ergänzungen unter der Mindestabnahmemenge werden mit dem Normalpreis verrechnet.

POS.	PROD.	ART.	MIS.	Q.TÀ	FIN.	EURO	FIN.	EURO
B. 10		BX-6020 SET 4	1500 mm	1 set	CR	627,30 /set	NO	705,30 /set
		BX-6020-3 SET 4	3000 mm	1 set	CR	676,70 /set	NO	743,30 /set
		BX-6020 SET4 ⚠	1500 mm	■ min 5 set	CR	547,00 */set		
		BX-6020 SET4 ⚠	1500 mm	■ min 10 set	CR	575,00 */set		
		BX-6020-3 SET4 ⚠	3000 mm	■ min 5 set	CR	608,00 /set		
		BX-6020-3 SET4 ⚠	3000 mm	■ min 10 set	CR	573,00 /set		
B. 11		BX-PT-01 SET4	1500 mm	1 set	CR	201,00 /set	NO	221,00 /set
		BX-PT-01 SET4 3M	3000 mm	1 set	CR	288,50 /set	NO	318,50 /set
		BX-PT-01 SET4 ■ Industrial packaging ▶ 156						
		BX-6020 SET 5 Profili a terra inclusi Floor profiles included Bodenprofile enthalten	3000 mm	1 set	CR	859,00 /set	NO	944,50 /set

BX-PT-01 ESEMPIO DI COSTO CON IMBALLO INDUSTRIALE
EXAMPLE TOTAL COST WITH COMPONENTS IN INDUSTRIAL PACKAGING
BEISPIEL GESAMTPREIS MIT INDUSTRIELLER VERPACKUNG

B. 12	PER/FOR/FÜR SET 1 SET 2 SET 3 SET 4	PER/FOR/FÜR SET 1 SET 2 SET 3 SET 4	PER/FOR/FÜR SET 1	PER/FOR/FÜR SET 2	PER/FOR/FÜR SET 3	PER/FOR/FÜR SET 4
	BX-PT-C58-CF12 ⚠ 3000 mm	BX-PT-C56-CF8 ⚠ 3000 mm	PLAST-PT1-S1-MIX	PLAST-PT1-S2-MIX	PLAST-PT1-S3-MIX	PLAST-PT1-S4-MIX
	CR 45,53 */1 pcs 546,30 /12 pcs	CR 33,63 */1 pcs 269,00 /8 pcs	CR 52,00 /1 kit	CR 43,30 /1 kit	CR 46,00 /1 kit	CR 46,00 /1 kit
	NO 69,39 */1 pcs 832,70 /12 pcs	NO 47,84 */1 pcs 382,70 /8 pcs	NO 67,50 /1 kit	NO 56,50 /1 kit	NO 59,50 /1 kit	NO 59,50 /1 kit

	BX-PT-01 SET 1	BX-PT-01 SET 2	BX-PT-01 SET 3	BX-PT-01 SET 4
3000 mm	CR 115,00 /set	CR 106,00 /set	CR 109,00 /set	CR 109,00 /set
1500 mm *	-	CR 80,00* /set	CR 109,00 /set	CR 109,00 /set

MIX

- Minimo ordine 5 pezzi, anche assortiti, fra i vari set
- Minimum order 5 pc also a mixture of different sets
- Mindestbestellmenge: 5 Stück sortiert



- Tagliato dal cliente a 45°
- Cut 45° by installer
- Schnitt 45° bauseitig



- Tagliato dal cliente
- Cut by installer
- Schnitt bauseitig

POS.	PROD.	ART.	MIS.	Q.TÀ	FIN.	EURO	FIN.	EURO	
		BX-6000 ETEREA / BX-6020 ETEREA SOFT-CLOSE <i>COMPONENTI / COMPONENTS / EINZELTEILE</i>			▶ BOX DOCCIA 30/32				
B. 13		BX-6000-C43-1500	1500 mm	1 pc	CR	106,00 /pc	NO	124,30 /pc	
		BX-6000-C43-3000	3000 mm	1 pc	CR	155,30 /pc	NO	162,00 /pc	
		BX-6000-C40-1000x1000	1000x1000 mm	2 pcs	CR	152,70 /set	NO	166,50 /set	
		BX-6000-C43-CF4-3000 ⚠	3000 mm	■ 4 pcs	CR	121,68 /pc 486,70 /4 pc	NO	127,38 /pc 509,50 /4 pc	
		BX-6000-C43-CF8-3000 ⚠	3000 mm	■ 8 pcs	CR	111,21 /pc 889,70 /8 pc	NO	116,96 /pc 935,70 /8 pc	
B. 14		BX-6000-C10		1 pc	CR	106,00 /pc	NO	117,50 /pc	
		BX-6000-C10		■ min 5 pcs	CR	99,00 /pc	NO	108,30 /pc	
				■ min 10 pcs	CR	92,00 /pc	NO	99,00 /pc	
B. 15		BX-6000-C11 (per/for/für Soft-close)		1 pc	CR	115,00 /pc	NO	126,30 /pc	
		BX-6000-C11-CF5 (per/for/für Soft-close)		■ min 5 pcs	CR	108,30 /pc	NO	119,50 /pc	
				■ min 10 pcs	CR	101,30 /pc	NO	110,30 /pc	
B. 16		BX-6000-C12 (per/for/für Soft-close)		1 pc	CR	118,50 /pc	NO	130,00 /pc	
		BX-6000-C12 (per/for/für Soft-close)		■ min 5 pcs	CR	111,30 /pc	NO	123,00 /pc	
				■ min 10 pcs	CR	104,70 /pc	NO	114,00 /pc	
B. 17		BX-6000-C70-2 DX DX		1 pc	CR	63,30 /pc	NO	71,50 /pc	
		BX-6000-C70-2 DX		■ min 5 pcs	CR	60,00 /pc	NO	67,00 /pc	
				■ min 10 pcs	CR	56,50 /pc	NO	62,30 /pc	
B. 18		BX-6000-C70-2 SX SX		1 pc	CR	63,30 /pc	NO	71,50 /pc	
		BX-6000-C70-2 SX		■ min 5 pcs	CR	60,00 /pc	NO	67,00 /pc	
				■ min 10 pcs	CR	56,50 /pc	NO	62,30 /pc	
B. 19		BX-6000-C70-1		1 pc	CR	56,50 /pc	NO	68,30 /pc	
		BX-6000-C70-1		■ min 5 pcs	CR	49,50 /pc	NO	59,00 /pc	
				■ min 10 pcs	CR	46,30 /pc	NO	52,00 /pc	

- Confezioni industriali
- Industrial packaging
- Industrieverpackungen

- ⚠ **Confezioni profili** con quantità fissa, disponibili solo in multipli della quantità indicata.
- **Packs of profiles** with fixed quantity, available only in multiples of the indicated quantity.
- **Profilpackungen** mit fixer Menge sind nur als Vielfaches der angeführten Menge erhältlich.

■ **min**

- Prezzi speciali per l'acquisto delle quantità minime indicate (CF) dell'articolo. NB: eventuali riordini o aggiunte per completamenti se di quantità inferiore alla minima, saranno fatturati al prezzo normale
- Special prices for the purchase of the minimum quantities indicated (CF) of the article. Note Well: any reorders or additions for completions of quantity less than the minimum will be invoiced at the normal price.
- Artikel mit Sonderpreisen bei Mindestabnahmemengen sind mit (CF) gekennzeichnet. Nachbestellungen oder Ergänzungen unter der Mindestabnahmemenge werden mit dem Normalpreis verrechnet.

POS.	PROD.	ART.	MIS.	Q.TÀ	FIN.	EURO	FIN.	EURO
B. 20		BX-6000-C90 DX		1 pc	CR	37,00 /pc	NO	44,00 /pc
		BX-6000-C90 DX	■ min 5 pcs	CR	35,00 /pc	NO	38,00 /pc	
			■ min 10 pcs	CR	33,00 /pc	NO	36,00 /pc	
B. 21		BX-6000-C90 SX		1 pc	CR	37,00 /pc	NO	44,00 /pc
		BX-6000-C90 SX	■ min 5 pcs	CR	35,00 /pc	NO	38,00 /pc	
			■ min 10 pcs	CR	33,00 /pc	NO	36,00 /pc	
B. 22		BX-6000-C81		1 pc	CR	37,00 /pc	NO	48,30 /pc
		BX-6000-C81-CF5	■ min 5 pcs	CR	33,00 /pc	NO	43,00 /pc	
			■ min 10 pcs	CR	30,30 /pc	NO	39,70 /pc	
B. 23		BX-6000-C20		1 pc	CR	71,50 /pc	NO	81,70 /pc
		BX-6000-C20	■ min 5 pcs	CR	68,30 /pc	NO	79,50 /pc	
			■ min 10 pcs	CR	66,00 /pc	NO	77,50 /pc	
B. 24		BX-6000-C30		1 pc	CR	44,00 /pc		
		BX-6000-C30	■ min 5 pcs	CR	38,00 /pc			
			■ min 10 pcs	CR	35,30 /pc			
B. 25		BX-6000-SOFT-CLOSE		1 pc		108,30 /pc		
		BX-6000-SOFT-CLOSE	■ min 5 pcs		99,00 /pc			
			■ min 10 pcs		99,00 /pc			
B. 26		BX-6000-DIMA		1 pc		15,30 /pc		
		BX-6000-DIMA	■ min 5 pcs		13,50 /pc			
			■ min 10 pcs		13,50 /pc			
B. 27		BX-PT-C50		1 pc	CR	22,30 /pc	NO	25,50 /pc
		BX-PT-C50-CF10	■ min 10 pcs	CR	14,70 /pc	NO	17,00 /pc	
B. 27.1		BX-6000 ECCENTR		1 pair	CR	55,70 /pair		

POS.	PROD.	ART.	MIS.	Q.TÀ	FIN.	EURO	FIN.	EURO	
BOX DOCCIA CON SISTEMA SCORREVOLE <i>SHOWER BOX WITH SLIDING SYSTEM / DUSCHKABINEN MIT SCHIEBETÜRSYSTEM</i>									
BX-4000 LINEA 30 ▶ BOX DOCCIA 34/41									
B. 28		BX-4000 SET 1	1000x1000 mm	1 set	CR	684,30 /set	NO	749,30 /set	
		BX-4000 SET 1 ⚠	3000 mm	■ min 5 set	CR	578,00 ^/set			
		BX-4000 SET 1 ⚠	3000 mm	■ min 10 set	CR	532,00 ^/set			
		OPTIONAL 	BX-PT-01 SET 1		1 set	CR	181,00 /set	NO	199,30 /set
		BX-PT-01 SET 1 ■ Industrial packaging ▶ 156							
B. 29		BX-4000 SET 2	1500 mm	1 set	CR	431,30 /set	NO	460,30 /set	
		BX-4000-3 SET 2	3000 mm	1 set	CR	516,70 /set	NO	545,30 /set	
		BX-4000 SET 2 ⚠	1500 mm	■ min 5 set	CR	343,00 */set			
		BX-4000 SET 2 ⚠	1500 mm	■ min 10 set	CR	319,00 */set			
		BX-4000-3 SET 2 ⚠	3000 mm	■ min 5 set	CR	429,00 /set			
		BX-4000-3 SET 2 ⚠	3000 mm	■ min 10 set	CR	406,00 /set			
	OPTIONAL 	BX-PT-01 SET 2	1500 mm	1 set	CR	112,00 /set	NO	119,50 /set	
	BX-PT-01 SET 2 3M	3000 mm	1 set	CR	163,00 /set	NO	182,00 /set		
	BX-PT-01 SET 2 ■ Industrial packaging ▶ 156								
B. 30		BX-4000 SET 3	1500 mm	1 set	CR	495,30 /set	NO	531,50 /set	
		BX-4000-3 SET 3	3000 mm	1 set	CR	586,50 /set	NO	625,30 /set	
		BX-4000 SET 3 ⚠	1500 mm	■ min 5 set	CR	399,00 */set			
		BX-4000 SET 3 ⚠	1500 mm	■ min 10 set	CR	369,00 */set			
		BX-4000-3 SET 3 ⚠	3000 mm	■ min 5 set	CR	486,00 /set			
		BX-4000-3 SET 3 ⚠	3000 mm	■ min 10 set	CR	455,00 /set			
	OPTIONAL 	BX-PT-01 SET 3	1500 mm	1 set	CR	201,00 /set	NO	221,00 /set	
	BX-PT-01 SET 3 3M	3000 mm	1 set	CR	288,50 /set	NO	318,50 /set		
	BX-PT-01 SET 3 ■ Industrial packaging ▶ 156								

- Confezioni industriali
- Industrial packaging
- Industrieverpackungen

- ⚠ **ESEMPIO DI COSTO CON IMBALLO INDUSTRIALE. Confezioni profili** con quantità fissa, disponibili solo in multipli della quantità indicata. Vedi pag. 140
- **EXAMPLE TOTAL COST WITH COMPONENTS IN INDUSTRIAL PACKAGING. Packs of profiles** with fixed quantity, available only in multiples of the indicated quantity. Page 140
- **BEISPIEL GESAMTPREIS MIT INDUSTRIELLER VERPACKUNG. Profilpackungen** mit fixer Menge sind nur als Vielfaches der angeführten Menge erhältlich. Siehe Seite 140

■ **min**

- Prezzi speciali per l'acquisto delle quantità minime indicate (CF) dell'articolo. NB: eventuali riordini o aggiunte per completamenti se di quantità inferiore alla minima, saranno fatturati al prezzo normale
- Special prices for the purchase of the minimum quantities indicated (CF) of the article. Note Well: any reorders or additions for completions of quantity less than the minimum will be invoiced at the normal price.
- Artikel mit Sonderpreisen bei Mindestabnahmemengen sind mit (CF) gekennzeichnet. Nachbestellungen oder Ergänzungen unter der Mindestabnahmemenge werden mit dem Normalpreis verrechnet.

POS.	PROD.	ART.	MIS.	Q.TÀ	FIN.	EURO	FIN.	EURO
B. 31		BX-4000 SET 4	1500 mm	1 set	CR	451,30 /set	NO	481,30 /set
		BX-4000-3 SET 4	3000 mm	1 set	CR	532,50 /set	NO	569,00 /set
		BX-4000 SET4 ⚠	1500 mm	■ min 5 set	CR	371,00 */set		
		BX-4000 SET4 ⚠	1500 mm	■ min 10 set	CR	344,00 */set		
		BX-4000-3 SET4 ⚠	3000 mm	■ min 5 set	CR	458,00 /set		
		BX-4000-3 SET4 ⚠	3000 mm	■ min 10 set	CR	371,00 /set		
OPTIONAL 	BX-PT-01 SET4	1500 mm	1 set	CR	201,00 /set	NO	221,00 /set	
	BX-PT-01 SET4 3M	3000 mm	1 set	CR	288,50 /set	NO	318,50 /set	
	BX-PT-01 SET4 ■ Industrial packaging ▶ 156							
B. 32		BX-4000 SET 5 Profili a terra inclusi Floor profiles included Bodenprofile enthalten	3000 mm	1 set	CR	716,00 /set	NO	801,50 /set
B. 33		BX-4000 SET 6 Profili a terra inclusi Floor profiles included Bodenprofile enthalten	3000 mm	1 set	CR	883,00 /set	NO	988,50 /set

BX-PT-01 ESEMPIO DI COSTO CON IMBALLO INDUSTRIALE
EXAMPLE TOTAL COST WITH COMPONENTS IN INDUSTRIAL PACKAGING
BEISPIEL GESAMTPREIS MIT INDUSTRIELLER VERPACKUNG

B. 34	PER/FOR/FÜR SET 1 SET 2 SET 3 SET 4	PER/FOR/FÜR SET 1 SET 2 SET 3 SET 4	PER/FOR/FÜR SET 1	PER/FOR/FÜR SET 2	PER/FOR/FÜR SET 3	PER/FOR/FÜR SET 4
	BX-PT-C58-CF12 ⚠ 3000 mm	BX-PT-C56-CF8 ⚠ 3000 mm	PLAST-PT1-S1-MIX	PLAST-PT1-S2-MIX	PLAST-PT1-S3-MIX	PLAST-PT1-S4-MIX
	CR 45,53 */1 pcs 546,30 /12 pcs	CR 33,63 */1 pcs 269,00 /8 pcs	CR 52,00 /1 kit	CR 43,30 /1 kit	CR 46,00 /1 kit	CR 46,00 /1 kit
	NO 69,39 */1 pcs 832,70 /12 pcs	NO 47,84 */1 pcs 382,70 /8 pcs	NO 67,50 /1 kit	NO 56,50 /1 kit	NO 59,50 /1 kit	NO 59,50 /1 kit
			BX-PT-01 SET 1	BX-PT-01 SET 2	BX-PT-01 SET 3	BX-PT-01 SET 4
	3000 mm		CR 115,00 /set	CR 106,00 /set	CR 109,00 /set	CR 109,00 /set
	1500 mm *		-	CR 80,00* /set	CR 109,00 /set	CR 109,00 /set

MIX







- Minimo ordine 5 pezzi, anche assortiti, fra i vari set
- Minimum order 5 pc also a mixture of different sets
- Mindestbestellmenge: 5 Stück sortiert



- Tagliato dal cliente a 45°
- Cut 45° by installer
- Schnitt 45° bauseitig



- Tagliato dal cliente
- Cut by installer
- Schnitt bauseitig

POS.	PROD.	ART.	MIS.	Q.TÀ	FIN.	EURO	FIN.	EURO
BX-4000 LINEA 30								
<i>COMPONENTI / COMPONENTS / EINZELTEILE</i>		▶ BOX DOCCIA 42/43						
B. 35		BX-4000-C43-1500	1500 mm	1 pc	CR	173,50 /pc	NO	168,30 /pc
		BX-4000-C43-3000	3000 mm	1 pc	CR	247,30 /pc	NO	221,00 /pc
		BX-4000-C40-1000x1000	1000x1000 mm	2 pc 45°	CR	258,50 /set	NO	253,70 /set
		BX-4000-C43-CF4-3000 ⚠ (BX-4001 non incluso not included / nicht enthalten)	3000 mm	■ 4 pcs	CR	172,38 /pc 689,50 /4 pc	NO	142,25 /pc 569,00 /4 pc
B. 36		BX-4001-CF4 ⚠	2200 mm	■ 4 pcs	CR	45,63 /pc 182,50 /4 pc	NO	50,93 /pc 203,70 /4 pc
B. 37		BX-4000-C10		1 pc	CR	63,30 /pc	NO	78,50 /pc
		BX-4000-C10		■ min 5 pcs	CR	51,00 /pc	NO	56,50 /pc
		BX-4000-C10		■ min 10 pcs	CR	47,00 /pc	NO	53,00 /pc
B. 38		BX-4000-C90 DX		1 pc	CR	43,00 /pc	NO	54,70 /pc
		BX-4000-C90 DX		■ min 5 pcs	CR	36,00 /pc	NO	41,70 /pc
		BX-4000-C90 DX		■ min 10 pcs	CR	32,30 /pc	NO	37,30 /pc
B. 39		BX-4000-C90 SX		1 pc	CR	43,00 /pc	NO	54,70 /pc
		BX-4000-C90 SX		■ min 5 pcs	CR	36,00 /pc	NO	41,70 /pc
		BX-4000-C90 SX		■ min 10 pcs	CR	32,30 /pc	NO	37,30 /pc
B. 40		BX-4000-C81		1 pc	CR	34,30 /pc	NO	43,00 /pc
		BX-4000-C81		■ min 5 pcs	CR	29,00 /pc	NO	32,50 /pc
		BX-4000-C81		■ min 10 pcs	CR	25,00 /pc	NO	28,70 /pc

- Confezioni industriali
- Industrial packaging
- Industrieverpackungen

- ⚠ **Confezioni profili** con quantità fissa, disponibili solo in multipli della quantità indicata.
- **Packs of profiles** with fixed quantity, available only in multiples of the indicated quantity.
- **Profilpackungen** mit fixer Menge sind nur als Vielfaches der angeführten Menge erhältlich.

■ min

- Prezzi speciali per l'acquisto delle quantità minime indicate (CF) dell'articolo. NB: eventuali riordini o aggiunte per completamenti se di quantità inferiore alla minima, saranno fatturati al prezzo normale
- Special prices for the purchase of the minimum quantities indicated (CF) of the article. Note Well: any reorders or additions for completions of quantity less than the minimum will be invoiced at the normal price.
- Artikel mit Sonderpreisen bei Mindestabnahmemengen sind mit (CF) gekennzeichnet. Nachbestellungen oder Ergänzungen unter der Mindestabnahmemenge werden mit dem Normalpreis verrechnet.

POS.	PROD.	ART.	MIS.	Q.TÀ	FIN.	EURO	FIN.	EURO
B. 41		BX-4000-C30		1 pc	CR	39,70 /pc	NO	50,70 /pc
		BX-4000-C30	■ min 5 pcs		CR	32,50 /pc	NO	38,00 /pc
		BX-4000-C30	■ min 10 pcs		CR	29,50 /pc	NO	34,00 /pc
B. 42		BX-4000-C20		1 pc	CR	49,30 /pc	NO	62,00 /pc
		BX-4000-C20	■ min 5 pcs		CR	43,00 /pc	NO	48,30 /pc
		BX-4000-C20	■ min 10 pcs		CR	38,70 /pc	NO	44,00 /pc
B. 43		BX-4050		1 pc	CR	41,00 /pc	NO	46,00 /pc
		BX-4050	■ min 5 pcs		CR	29,00 /pc	NO	37,00 /pc
		BX-4050	■ min 10 pcs		CR	23,00 /pc	NO	26,00 /pc

POS.	PROD.	ART.	MIS.	Q.TÀ	FIN.	EURO	FIN.	EURO	
BX-3100 (OPTIONAL SOFT-CLOSE)						▶ BOX DOCCIA 44/51			
B. 44		BX-3100 SET 1	1000x1000 mm	1 set	CR	856,50 /set	NO	925,70 /set	
		BX-3100 SET 1	3000 mm	■ min 5 set	CR	645,00 [^] /set			
		BX-PT-01 SET1			1 set	CR	181,00 /set	NO	199,30 /set
		BX-PT-01 SET1	Industrial packaging ▶ 156						
		BX-3106 (OPTIONAL SOFT-CLOSE)		1 pc		53,00 (2x) /pc			
B. 45		BX-3100 SET 2	1500 mm	1 set	CR	522,70 /set	NO	569,30 /set	
		BX-3100-3 SET 2	3000 mm	1 set	CR	650,70 /set	NO	692,00 /set	
		BX-3100 SET 2	1500 mm	■ min 5 set	CR	390,00 /set			
		BX-3100-3 SET 2	3000 mm	■ min 5 set	CR	581,00 /set			
		BX-PT-01 SET2	1500 mm	1 set	CR	112,00 /set	NO	119,50 /set	
		BX-PT-01 SET2 3M	3000 mm	1 set	CR	163,00 /set	NO	182,00 /set	
		BX-3106 (OPTIONAL SOFT-CLOSE)		1 pc		53,00 /pc			
B. 46		BX-3100 SET 3	1500 mm	1 set	CR	559,70 /set	NO	614,50 /set	
		BX-3100-3 SET 3	3000 mm	1 set	CR	687,30 /set	NO	737,30 /set	
		BX-3100 SET 3	1500 mm	■ min 5 set	CR	443,00 /set			
		BX-3100-3 SET 3	3000 mm	■ min 5 set	CR	633,00 /set			
		BX-PT-01 SET3	1500 mm	1 set	CR	201,00 /set	NO	221,00 /set	
		BX-PT-01 SET3 3M	3000 mm	1 set	CR	288,50 /set	NO	318,50 /set	
		BX-3106 (OPTIONAL SOFT-CLOSE)		1 pc		53,00 /pc			

- Confezioni industriali
- Industrial packaging
- Industrieverpackungen

- ESEMPIO DI COSTO CON IMBALLO INDUSTRIALE. **Confezioni profili** con quantità fissa, disponibili solo in multipli della quantità indicata. Vedi pag. 144
- EXAMPLE TOTAL COST WITH COMPONENTS IN INDUSTRIAL PACKAGING. **Packs of profiles** with fixed quantity, available only in multiples of the indicated quantity. Page 144
- BEISPIEL GESAMTPREIS MIT INDUSTRIELLER VERPACKUNG. **Profilpackungen** mit fixer Menge sind nur als Vielfaches der angeführten Menge erhältlich. Siehe Seite 144

CF

- Prezzi speciali per l'acquisto delle quantità minime indicate (CF) dell'articolo. NB: eventuali riordini o aggiunte per complementi se di quantità inferiore alla minima, saranno fatturati al prezzo normale
- Special prices for the purchase of the minimum quantities indicated (CF) of the article. Note Well: any reorders or additions for completions of quantity less than the minimum will be invoiced at the normal price.
- Artikel mit Sonderpreisen bei Mindestabnahmemengen sind mit (CF) gekennzeichnet. Nachbestellungen oder Ergänzungen unter der Mindestabnahmemenge werden mit dem Normalpreis verrechnet.

POS.	PROD.	ART.	MIS.	Q.TÀ	FIN.	EURO	FIN.	EURO	
B. 47		BX-3100 SET 4	1500 mm	1 set	CR	540,70 /set	NO	592,00 /set	
		BX-3100-3 SET 4	3000 mm	1 set	CR	669,50 /set	NO	716,00 /set	
		BX-3100 SET 4 ⚠	1500 mm	■ min 5 set	CR	390,00 /set			
		BX-3100-3 SET 4 ⚠	3000 mm	■ min 5 set	CR	607,00 /set			
		STANDARD	BX-PT-01 SET4	1500 mm	1 set	CR	201,00 /set	NO	221,00 /set
			BX-PT-01 SET4 3M	3000 mm	1 set	CR	288,50 /set	NO	318,50 /set
			BX-PT-01 SET4 ■ Industrial packaging ▶ 156						
		OPTIONAL	BX-3106 (OPTIONAL SOFT-CLOSE)		1 pc		53,00 /pc		
			BX-3106 (OPTIONAL SOFT-CLOSE)		■ min 5 pcs		40,00 /pc		
	B. 48		BX-3100 SET 5 Profili a terra inclusi Floor profiles included Bodenprofile enthalten	3000 mm	1 set	CR	858,00 /set	NO	944,00 /set
B. 49		BX-3100 SET 6 Profili a terra inclusi Floor profiles included Bodenprofile enthalten	3000 mm	1 set	CR	998,00 /set	NO	1098,70 /set	

BX-PT-01 ESEMPIO DI COSTO CON IMBALLO INDUSTRIALE
EXAMPLE TOTAL COST WITH COMPONENTS IN INDUSTRIAL PACKAGING
BEISPIEL GESAMTPREIS MIT INDUSTRIELLER VERPACKUNG

B. 50	PER/FOR/FÜR SET 1 SET 2 SET 3 SET 4	PER/FOR/FÜR SET 1 SET 2 SET 3 SET 4	PER/FOR/FÜR SET 1	PER/FOR/FÜR SET 2	PER/FOR/FÜR SET 3	PER/FOR/FÜR SET 4
	BX-PT-C58-CF12 ⚠ 3000 mm	BX-PT-C56-CF8 ⚠ 3000 mm	PLAST-PT1-S1-MIX	PLAST-PT1-S2-MIX	PLAST-PT1-S3-MIX	PLAST-PT1-S4-MIX
	CR 45,53 * /1 pcs 546,30 /12 pcs	CR 33,63 * /1 pcs 269,00 /8 pcs	CR 52,00 /1 kit	CR 43,30 /1 kit	CR 46,00 /1 kit	CR 46,00 /1 kit
NO 69,39 * /1 pcs 832,70 /12 pcs	NO 47,84 * /1 pcs 382,70 /8 pcs	NO 67,50 /1 kit	NO 56,50 /1 kit	NO 59,50 /1 kit	NO 59,50 /1 kit	

	BX-PT-01 SET 1	BX-PT-01 SET 2	BX-PT-01 SET 3	BX-PT-01 SET 4
3000 mm	CR 115,00 /set	CR 106,00 /set	CR 109,00 /set	CR 109,00 /set
1500 mm *	-	CR 80,00* /set	CR 109,00 /set	CR 109,00 /set

MIX

- Minimo ordine 5 pezzi, anche assortiti, fra i vari set
- Minimum order 5 pc also a mixture of different sets
- Mindestbestellmenge: 5 Stück sortiert



- Tagliato dal cliente a 45°
- Cut 45° by installer
- Schnitt 45° bauseitig



- Tagliato dal cliente
- Cut by installer
- Schnitt bauseitig

POS.	PROD.	ART.	MIS.	Q.TÀ	FIN.	EURO	FIN.	EURO
BX-3100 (OPTIONAL SOFT-CLOSE)						▶ BOX DOCCIA 52/53		
<i>COMPONENTI / COMPONENTS / EINZELTEILE</i>								
B.51		BX-3100-C43-1500	1500 mm	1 pc	CR	286,70 /pc	NO	302,30 /pc
		BX-3100-C43-3000	3000 mm	1 pc	CR	414,30 /pc	NO	425,00 /pc
		BX-3100-C40-1000x1000	1000x1000 mm	2 pc 45°	CR	425,00 /pc	NO	446,30 /pc
		BX-3100-C43-CF4-3000	3000 mm	■ 4 pcs	CR	379,58 /pc 1518,30 /4 pcs	NO	390,25 /pc 1561,00 /4 pcs
B.52		BX-3100-C10		1 pc	CR	118,50 /pc		
		BX-3100-C10		■ min 5 pcs	CR	105,30 /pc		
B.53		BX-3150		1 pc	CR	43,30 /pc	NO	48,30 /set
		BX-3150		■ min 5 pcs	CR	26,50 /pc	NO	30,30 /pc
B.54		BX-3106 SOFT-CLOSE		1 pc		53,00 /pc		
		BX-3106 SOFT-CLOSE		■ min 5 pcs	CR	40,00 /pc		
B.55		BX-3100-C90 DX		1 pc	CR	46,00 /pc	NO	61,50 /pc
		BX-3100-C90 DX		■ min 5 pcs	CR	34,00 /pc	NO	50,70 /pc
B.56		BX-3100-C90 SX		1 pc	CR	46,00 /pc	NO	61,50 /pc
		BX-3100-C90 SX		■ min 5 pcs	CR	34,00 /pc	NO	50,70 /pc

- Confezioni industriali
- Industrial packaging
- Industrieverpackungen

- Confezioni profili** con quantità fissa, disponibili solo in multipli della quantità indicata.
- **Packs of profiles** with fixed quantity, available only in multiples of the indicated quantity.
- **Profilpackungen** mit fixer Menge sind nur als Vielfaches der angeführten Menge erhältlich.

■ **min**

- Prezzi speciali per l'acquisto delle quantità minime indicate (CF) dell'articolo. NB: eventuali riordini o aggiunte per completamenti se di quantità inferiore alla minima, saranno fatturati al prezzo normale
- Special prices for the purchase of the minimum quantities indicated (CF) of the article. Note Well: any reorders or additions for completions of quantity less than the minimum will be invoiced at the normal price.
- Artikel mit Sonderpreisen bei Mindestabnahmemengen sind mit (CF) gekennzeichnet. Nachbestellungen oder Ergänzungen unter der Mindestabnahmemenge werden mit dem Normalpreis verrechnet.

POS.	PROD.	ART.	MIS.	Q.TÀ	FIN.	EURO	FIN.	EURO
B. 57		BX-3100-C81 DX		1 pc	CR	37,30 /pc	NO	47,00 /pc
		BX-3100-C81 DX		■ min 5 pcs	CR	26,50 /pc	NO	36,30 /pc
B. 58		BX-3100-C81 SX		1 pc	CR	37,30 /pc	NO	47,00 /pc
		BX-3100-C81 SX		■ min 5 pcs	CR	26,50 /pc	NO	36,30 /pc
B. 59		BX-3100-C20		1 pc	CR	50,70 /pc	NO	67,50 /pc
		BX-3100-C20		■ min 5 pcs	CR	38,50 /pc	NO	56,50 /pc

POS.	PROD.	ART.	MIS.	Q.TÀ	FIN.	EURO	FIN.	EURO		
	BX-1501							► BOX DOCCIA 54/59		
B. 60		BX-1501 SET 1	1000x1000 mm	1 set	CR	819,50 /set	IXE	1000,00 /set		
		BX-1501 SET 1 ⚠	3000 mm	■ min 5 set	CR	717,00 ^/set				
		BX-PT-01 SET1		1 set	CR	181,00 /set				
		BX-PT-01 SET1 ■ Industrial packaging ► 156								
		BX-PT-02 SET1		1 set	CR	244,70 /set				
			BX-PT-03 SET1		1 set	CR	203,30 /set			
				BX-1501 SET 2	1500 mm	1 set	CR	491,70 /set	IXE	600,00 /set
				BX-1501-3 SET 2	3000 mm	1 set	CR	551,30 /set	IXE	673,00 /set
BX-1501 SET2 ⚠	1500 mm			■ min 5 set	CR	372,00 /set				
BX-1501-3 SET2 ⚠	3000 mm	■ min 5 set		CR	429,00 /set					
B. 61		BX-PT-01 SET2	1500 mm	1 set	CR	112,00 /set				
		BX-PT-01 SET2 3M	3000 mm	1 set	CR	163,00 /set				
		BX-PT-01 SET2 ■ Industrial packaging ► 156								
		BX-PT-02 SET2-3-4		1 set	CR	155,30 /set				
			BX-PT-03 SET2-3-4		1 set	CR	126,70 /set			

- Confezioni industriali
- Industrial packaging
- Industrieverpackungen

⚠ **ESEMPIO DI COSTO CON IMBALLO INDUSTRIALE.**
Confezioni profili con quantità fissa, disponibili solo in multipli della quantità indicata. Vedi pag. 149
EXAMPLE TOTAL COST WITH COMPONENTS IN INDUSTRIAL PACKAGING. **Packs of profiles** with fixed quantity, available only in multiples of the indicated quantity. Page 149
BEISPIEL GESAMTPREIS MIT INDUSTRIELLER VERPACKUNG. **Profilpackungen** mit fixer Menge sind nur als Vielfaches der angeführten Menge erhältlich. Siehe Seite 149

■ **min**

- Prezzi speciali per l'acquisto delle quantità minime indicate (CF) dell'articolo. NB: eventuali riordini o aggiunte per completamenti se di quantità inferiore alla minima, saranno fatturati al prezzo normale
- Special prices for the purchase of the minimum quantities indicated (CF) of the article. Note Well: any reorders or additions for completions of quantity less than the minimum will be invoiced at the normal price.
- Artikel mit Sonderpreisen bei Mindestabnahmemengen sind mit (CF) gekennzeichnet. Nachbestellungen oder Ergänzungen unter der Mindestabnahmemenge werden mit dem Normalpreis verrechnet.

POS.	PROD.	ART.	MIS.	Q.TÀ	FIN.	EURO	FIN.	EURO
B. 62		BX-1501 SET 3	1500 mm	1 set	CR	531,30 /set	IXE	648,00 /set
		BX-1501-3 SET 3	3000 mm	1 set	CR	591,00 /set	IXE	720,50 /set
		BX-1501 SET 3 ⚠	1500 mm	■ min 5 set	CR	418,00 /set		
		BX-1501-3 SET 3 ⚠	3000 mm	■ min 5 set	CR	496,00 /set		
	<p>OPTIONAL</p>	BX-PT-01 SET3	1500 mm	1 set	CR	201,00 /set		
		BX-PT-01 SET3 3M	3000 mm	1 set	CR	288,50 /set		
		BX-PT-01 SET3 ■ Industrial packaging ▶ 156						
	<p>OPTIONAL</p>	BX-PT-02 SET2-3-4		1 set	CR	155,30 /set		
		BX-PT-03 SET2-3-4		1 set	CR	126,70 /set		
	B. 63		BX-1501 SET 4	1500 mm	1 set	CR	511,70 /set	IXE
BX-1501-3 SET 4			3000 mm	1 set	CR	571,50 /set	IXE	698,30 /set
BX-1501 SET 4 ⚠			1500 mm	■ min 5 set	CR	395,00 /set		
BX-1501-3 SET 4 ⚠			3000 mm	■ min 5 set	CR	473,00 /set		
<p>OPTIONAL</p>		BX-PT-01 SET4	1500 mm	1 set	CR	201,00 /set		
		BX-PT-01 SET4 3M	3000 mm	1 set	CR	288,50 /set		
		BX-PT-01 SET4 ■ Industrial packaging ▶ 156						
<p>OPTIONAL</p>		BX-PT-02 SET2-3-4		1 set	CR	155,30 /set		
		BX-PT-03 SET2-3-4		1 set	CR	126,70 /set		

MIX





- Minimo ordine 5 pezzi, anche assortiti, fra i vari set
- Minimum order 5 pc also a mixture of different sets
- Mindestbestellmenge: 5 Stück sortiert





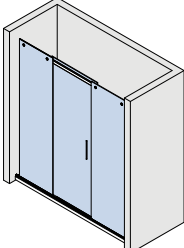

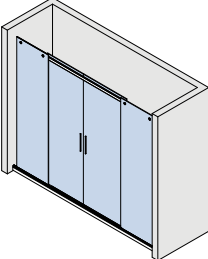
- Tagliato dal cliente a **45°**
- Cut **45°** by installer
- Schnitt **45°** bauseitig

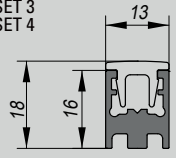
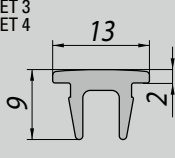

- Tagliato dal cliente
- Cut by installer
- Schnitt bauseitig

POS.	PROD.	ART.	MIS.	Q.TÀ	FIN.	EURO	FIN.	EURO
B. 64		BX-1501 SET 5 Profili a terra inclusi Floor profiles included Bodenprofile enthalten		3000 mm	1 set	CR	972,50 /set	
B. 65		BX-1501 SET 6 Profili a terra inclusi Floor profiles included Bodenprofile enthalten		3000 mm	1 set	CR	1300,70 /set	

BX-PT-01 ESEMPIO DI COSTO CON IMBALLO INDUSTRIALE
EXAMPLE TOTAL COST WITH COMPONENTS IN INDUSTRIAL PACKAGING
BEISPIEL GESAMTPREIS MIT INDUSTRIELLER VERPACKUNG

B. 66	PER/FOR/FÜR SET 1 SET 2 SET 3 SET 4	PER/FOR/FÜR SET 1 SET 2 SET 3 SET 4	PER/FOR/FÜR SET 1	PER/FOR/FÜR SET 2	PER/FOR/FÜR SET 3	PER/FOR/FÜR SET 4
						
BX-PT-C58-CF12 ⚠ 3000 mm	BX-PT-C56-CF8 ⚠ 3000 mm	PLAST-PT1-S1-MIX	PLAST-PT1-S2-MIX	PLAST-PT1-S3-MIX	PLAST-PT1-S4-MIX	
CR 45,53 */1 pc 546,30 /12 pcs	CR 33,63 */1 pc 269,00 /8 pc	CR 52,00 /1 kit	CR 43,30 /1 kit	CR 46,00 /1 kit	CR 46,00 /1 kit	
NO 69,39 */1 pc 832,70 /12 pcs	NO 47,84 */1 pc 382,70 /8 pc	NO 67,50 /1 kit	NO 56,50 /1 kit	NO 59,50 /1 kit	NO 59,50 /1 kit	



	BX-PT-01 SET 1	BX-PT-01 SET 2	BX-PT-01 SET 3	BX-PT-01 SET 4
3000 mm	CR 115,00 /set	CR 106,00 /set	CR 109,00 /set	CR 109,00 /set
1500 mm *	-	CR 80,00* /set	CR 109,00 /set	CR 109,00 /set

- Confezioni industriali
- Industrial packaging
- Industrieverpackungen

- ⚠ **Confezioni profili** con quantità fissa, disponibili solo in multipli della quantità indicata.
- **Packs of profiles** with fixed quantity, available only in multiples of the indicated quantity.
- **Profilpackungen** mit fixer Menge sind nur als Vielfaches der angeführten Menge erhältlich.

CF

- Prezzi speciali per l'acquisto delle quantità minime indicate (CF) dell'articolo. NB: eventuali riordini o aggiunte per completamenti se di quantità inferiore alla minima, saranno fatturati al prezzo normale
- Special prices for the purchase of the minimum quantities indicated (CF) of the article. Note Well: any reorders or additions for completions of quantity less than the minimum will be invoiced at the normal price.
- Artikel mit Sonderpreisen bei Mindestabnahmemengen sind mit (CF) gekennzeichnet. Nachbestellungen oder Ergänzungen unter der Mindestabnahmemenge werden mit dem Normalpreis verrechnet.

POS.	PROD.	ART.	MIS.	Q.TÀ	FIN.	EURO	FIN.	EURO	
BX-1501		COMPONENTI / COMPONENTS / EINZELTEILE							► BOX DOCCIA 60
B. 67		BX-1501-C43-1500	1500 mm	1 pc	CR	142,00 /pc	IXE	173,30 /pc	
		BX-1501-C43-3000	3000 mm	1 pc	CR	228,70 /pc	IXE	303,70 /pc	
		BX-1501-C40-1000x1000	1000x1000 mm	2 pc 45°	CR	255,00 /set	IXE	310,30 /set	
		BX-1501-C43-CF4-1500 ⚠	1500 mm	■ 4 pcs	CR	81,50 /pc 326,00 /4 pcs			
		BX-1501-C43-CF4-3000 ⚠	3000 mm	■ 4 pcs	CR	159,00 /pc 636,00 /4 pcs			
B. 68		BX-1501-C10		1 pc	CR	92,70 /pc	NS	99,30 /pc	
		BX-1501-C10		■ min 10 pcs	CR	64,30 /pc			
B. 69		BX-1501-C70		1 pc	CR	45,30 /pc	NS	51,30 /pc	
		BX-1501-C70		■ min 10 pcs	CR	25,50 /pc			
B. 70		BX-1501-C90 DX		1 pc	CR	62,70 /pc	NS	69,70 /pc	
		BX-1501-C90 DX		■ min 5 pcs	CR	37,30 /pc			
B. 71		BX-1501-C90 SX		1 pc	CR	62,70 /pc	NS	69,70 /pc	
		BX-1501-C90 SX		■ min 5 pcs	CR	37,30 /pc			
B. 72		BX-1501-C81		1 pc	CR	41,30 /pc	NS	48,30 /pc	
		BX-1501-C81		■ min 10 pcs	CR	23,50 /pc			
B. 73		BX-1501-C30		1 pc	CR	56,30 /pc	NS	63,00 /pc	
		BX-1501-C30		■ min 10 pcs	CR	37,70 /pc			
B. 74		BX-1501-C20		1 pc	CR	79,00 /pc	NS	86,30 /pc	
		BX-1501-C20		■ min 10 pcs	CR	51,00 /pc			

MIX

- Minimo ordine 5 pezzi, anche assortiti, fra i vari set
- Minimum order 5 pcs also a mixture of different sets
- Mindestbestellmenge: 5 Stück sortiert



- Tagliato dal cliente a **45°**
- Cut **45°** by installer
- Schnitt **45°** bauseitig



- Tagliato dal cliente
- Cut by installer
- Schnitt bauseitig

POS.	PROD.	ART.	MIS.	Q.TÀ	FIN.	EURO
BX-2000						▶ BOX DOCCIA 62/67
B. 75		BX-2000 SET 1	1000x1000 mm	1 set	CR	942,70 /set
		BX-PT-01 SET1		1 set	CR	181,00 /set
	BX-PT-01 SET1 ■ Industrial packaging ▶ 156					
		BX-PT-02 SET1		1 set	CR	244,70 /set
		BX-PT-03 SET1		1 set	CR	203,30 /set
B. 76		BX-2000 SET 2	2200 mm	1 set	CR	584,30 /set
		BX-PT-01 SET2	1500 mm	1 set	CR	112,00 /set
		BX-PT-01 SET2 3M	3000 mm	1 set	CR	163,00 /set
	BX-PT-01 SET2 ■ Industrial packaging ▶ 156					
		BX-PT-02 SET2-3-4		1 set	CR	155,30 /set
		BX-PT-03 SET2-3-4		1 set	CR	126,70 /set

- Confezioni industriali
- Industrial packaging
- Industrieverpackungen



- **Confezioni profili** con quantità fissa, disponibili solo in multipli della quantità indicata.
- **Packs of profiles** with fixed quantity, available only in multiples of the indicated quantity.
- **Profilpackungen** mit fixer Menge sind nur als Vielfaches der angeführten Menge erhältlich.

POS.	PROD.	ART.	MIS.	Q.TÀ	FIN.	EURO
B. 77		BX-2000 SET 3	2200 mm	1 set	CR	610,70 /set
		BX-PT-01 SET3	1500 mm	1 set	CR	201,00 /set
		BX-PT-01 SET3 3M	3000 mm	1 set	CR	288,50 /set
		BX-PT-01 SET3 ■ Industrial packaging ▶ 156				
			BX-PT-02 SET2-3-4		1 set	CR
		BX-PT-03 SET2-3-4		1 set	CR	126,70 /set
B. 78		BX-2000 SET 4	2200 mm	1 set	CR	596,30 /set
		BX-PT-01 SET4	1500 mm	1 set	CR	201,00 /set
		BX-PT-01 SET4 3M	3000 mm	1 set	CR	288,50 /set
		BX-PT-01 SET4 ■ Industrial packaging ▶ 156				
			BX-PT-02 SET2-3-4		1 set	CR
		BX-PT-03 SET2-3-4		1 set	CR	126,70 /set

POS.	PROD.	ART.	MIS.	Q.TÀ	FIN.	EURO
B. 79		BX-2000 SET 5 Profili a terra inclusi Floor profiles included Bodenprofile enthalten STANDARD	2200 mm	1 set	CR	1080,30 /set
B. 80		BX-2000 SET 6 Profili a terra inclusi Floor profiles included Bodenprofile enthalten STANDARD	2200 mm	1 set	CR	1473,50 /set

BX-PT-01 ESEMPIO DI COSTO CON IMBALLO INDUSTRIALE
 EXAMPLE TOTAL COST WITH COMPONENTS IN INDUSTRIAL PACKAGING
 BEISPIEL GESAMTPREIS MIT INDUSTRIELLER VERPACKUNG

B. 81	PER/FOR/FÜR SET 1 SET 2 SET 3 SET 4	PER/FOR/FÜR SET 1 SET 2 SET 3 SET 4	PER/FOR/FÜR SET 1	PER/FOR/FÜR SET 2	PER/FOR/FÜR SET 3	PER/FOR/FÜR SET 4
	BX-PT-C58-CF12 ⚠ 3000 mm	BX-PT-C56-CF8 ⚠ 3000 mm	PLAST-PT1-S1-MIX	PLAST-PT1-S2-MIX	PLAST-PT1-S3-MIX	PLAST-PT1-S4-MIX
	CR 45,53 */1 pc 546,30 /12 pcs	CR 33,63 */1 pc 269,00 /8 pc	CR 52,00 /1 kit	CR 43,30 /1 kit	CR 46,00 /1 kit	CR 46,00 /1 kit
	NO 69,39 */1 pc 832,70 /12 pcs	NO 47,84 */1 pc 382,70 /8 pc	NO 67,50 /1 kit	NO 56,50 /1 kit	NO 59,50 /1 kit	NO 59,50 /1 kit

	BX-PT-01 SET 1	BX-PT-01 SET 2	BX-PT-01 SET 3	BX-PT-01 SET 4
3000 mm	CR 115,00 /set	CR 106,00 /set	CR 109,00 /set	CR 109,00 /set
1500 mm *	-	CR 80,00* /set	CR 109,00 /set	CR 109,00 /set

- Confezioni industriali
- Industrial packaging
- Industrieverpackungen

- ⚠ **Confezioni profili** con quantità fissa, disponibili solo in multipli della quantità indicata.
- **Packs of profiles** with fixed quantity, available only in multiples of the indicated quantity.
- **Profilpackungen** mit fixer Menge sind nur als Vielfaches der angeführten Menge erhältlich.

CF

- Prezzi speciali per l'acquisto delle quantità minime indicate (CF) dell'articolo. NB: eventuali riordini o aggiunte per completamenti se di quantità inferiore alla minima, saranno fatturati al prezzo normale
- Special prices for the purchase of the minimum quantities indicated (CF) of the article. Note Well: any reorders or additions for completions of quantity less than the minimum will be invoiced at the normal price.
- Artikel mit Sonderpreisen bei Mindestabnahmemengen sind mit (CF) gekennzeichnet. Nachbestellungen oder Ergänzungen unter der Mindestabnahmemenge werden mit dem Normalpreis verrechnet.

POS.	PROD.	ART.	MIS.	Q.TÀ	FIN.	EURO	FIN.	EURO	
BX-2000		COMPONENTI / COMPONENTS / EINZELTEILE							► BOX DOCCIA 68
B. 82		BX-2000-C43	2200 mm	1 pc	CR	175,70 /pc			
		BX-2000-C40-1000x1000	1000x1000 mm	2 pc	CR	285,70 /set			
B. 83		BX-2000-C01		1 pc	CR	122,00 /pc			
B. 84		BX-2000-C03		1 pc	CR	24,00 /pc			
B. 85		BX-2000-C04		1 pc	CR	37,00 /pc			
B. 86		BX-2000-C07 DX		1 pc	CR	34,30 /pc			
B. 87		BX-2000-C07 SX		1 pc	CR	34,30 /pc			
B. 88		BX-2000-C08 DX		1 pc	CR	44,00 /pc			
B. 89		BX-2000-C08 SX		1 pc	CR	44,00 /pc			
B. 90		BX-2000-C02		1 pc	CR	20,30 /pc			
B. 91		BX-2000-C10		1 pc	CR	52,50 /pc			

MIX

- Minimo ordine 5 pezzi, anche assortiti, fra i vari set
- Minimum order 5 pcs also a mixture of different sets
- Mindestbestellmenge: 5 Stück sortiert



- Tagliato dal cliente a **45°**
- Cut **45°** by installer
- Schnitt **45°** bauseitig



- Tagliato dal cliente
- Cut by installer
- Schnitt bauseitig

POS.	PROD.	ART.	MIS.	Q.TÀ	FIN.	EURO	FIN.	EURO
PROFILI A TERRA (SET COMPLETI) FLOOR PROFILES (COMPLETE SET) / BODENPROFILE (KOMPLETTES SET)						▶ BOX DOCCIA 88		
A	BX-PT-01							
B. 92		BX-PT-01 SET1	3000 mm *	1 set	CR	181,00 /set	NO	199,30 /set
B. 93		BX-PT-01 SET2	1500 mm	1 set	CR	112,00 /set	NO	119,50 /set
		BX-PT-01 SET2 3M	3000 mm	1 set	CR	163,00 /set	NO	182,00 /set
B. 94		BX-PT-01 SET3	1500 mm	1 set	CR	201,00 /set	NO	221,00 /set
		BX-PT-01 SET3 3M	3000 mm	1 set	CR	288,50 /set	NO	318,50 /set
B. 95		BX-PT-01 SET4	1500 mm	1 set	CR	201,00 /set	NO	221,00 /set
		BX-PT-01 SET4 3M	3000 mm	1 set	CR	288,50 /set	NO	318,50 /set

*
• Tagliato dal cliente
• Cut by installer
• Schnitt bauseitig

POS.	PROD.	ART.	MIS.	Q.TÀ	FIN.	EURO	FIN.	EURO
------	-------	------	------	------	------	------	------	------

B BX-PT-02 ▶ BOX DOCCIA 89

B. 96

BX-PT-02 SET1	1100x1100 mm	1 set	CR	244,70 /set
----------------------	--------------	-------	----	--------------------

B. 97

BX-PT-02 SET2-3-4	1100 mm	1 set	CR	155,30 /set
--------------------------	---------	-------	----	--------------------

C BX-PT-03 ▶ BOX DOCCIA 90

B. 98

BX-PT-03 SET1	1050x1050 mm	1 set	CR	203,30 /set
----------------------	--------------	-------	----	--------------------

B. 99

BX-PT-03 SET2	1050 mm	1 set	CR	126,70 /set
----------------------	---------	-------	----	--------------------











POS.	PROD.	ART.	MIS.	Q.TÀ	FIN.	EURO	FIN.	EURO
PROFILI A TERRA (COMPONENTI) FLOOR PROFILES (COMPONENTS) / BODENPROFILE (EINZELTEILE)						▶ BOX DOCCIA 88/90		
B. 100		BX-PT-C58/56 CF1	1 pc BX-PT-C58 (1500 mm) + 1 pc BX-PT-C56 (1500 mm)		CR	66,30 /set	NO	90,00 /set
		BX-PT-C58/56 CF2	1 pc BX-PT-C58 (1500 mm) + 1 pc BX-PT-C58 (3000 mm) + 1 pc BX-PT-C56 (1500 mm)		CR	118,50 /set	NO	149,30 /set
		BX-C58/56 CF1 3M	1 pc BX-PT-C58 (3000 mm) + 1 pc BX-PT-C56 (3000 mm)		CR	106,00 /set	NO	143,70 /set
		BX-C58/56 CF2 3M	2 pc BX-PT-C58 (3000 mm) + 1 pc BX-PT-C56 (1500 mm)		CR	138,00 /set	NO	175,00 /set
B. 101		BX-PT-C58 MIX	3000 mm	min 5 pcs	CR	50,00 /pc	NO	74,00 /pc
		BX-PT-C58-CF12 ⚠	3000 mm	■ 12 pcs	CR	45,53 /pc 546,30 /12 pcs	NO	69,39 /pc 832,70 /12 pcs
B. 102		BX-PT-C56 MIX	3000 mm	min 5 pcs	CR	37,30 /pc	NO	54,30 /pc
		BX-PT-C56-CF8 ⚠	3000 mm	■ 8 pc	CR	33,63 /pc 269,00 /8 pc	NO	47,84 /pc 382,70 /8 pc
B. 103		PLAST-PT1-S1-MIX		min 5 set	CR	52,00 /set	NO	67,50 /set
B. 104		PLAST-PT1-S2-MIX		min 5 set	CR	43,30 /set	NO	56,50 /set
B. 105		PLAST-PT1-S3-MIX		min 5 set	CR	46,00 /set	NO	59,50 /set
B. 106		PLAST-PT1-S4-MIX		min 5 set	CR	46,00 /set	NO	59,50 /set

- Confezioni industriali
- Industrial packaging
- Industrieverpackungen

- ⚠ **Confezioni profili** con quantità fissa, disponibili solo in multipli della quantità indicata.
- **Packs of profiles** with fixed quantity, available only in multiples of the indicated quantity.
- **Profilpackungen** mit fixer Menge sind nur als Vielfaches der angeführten Menge erhältlich.

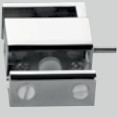
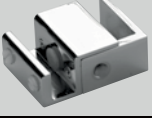



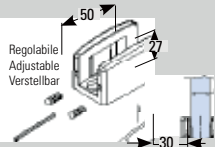

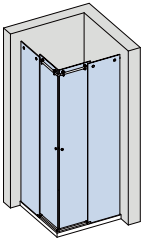

CF

- Prezzi speciali per l'acquisto delle quantità minime indicate (CF) dell'articolo. NB: eventuali riordini o aggiunte per completamenti se di quantità inferiore alla minima, saranno fatturati al prezzo normale
- Special prices for the purchase of the minimum quantities indicated (CF) of the article. Note Well: any reorders or additions for completions of quantity less than the minimum will be invoiced at the normal price.
- Artikel mit Sonderpreisen bei Mindestabnahmemengen sind mit (CF) gekennzeichnet. Nachbestellungen oder Ergänzungen unter der Mindestabnahmemenge werden mit dem Normalpreis verrechnet.

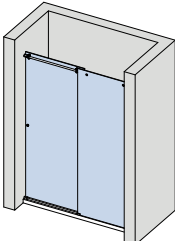
POS.	PROD.	ART.	MIS.	Q.TÀ	FIN.	EURO	FIN.	EURO
B. 107		BX-PT-C50		1 pc	CR	22,30 /pc	NO	25,50 /pc
		BX-PT-C50		■ min 10 pcs	CR	14,70 /pc	NO	17,00 /pc /10 pcs
B. 108		BX-4050		1 pc	CR	41,00 /pc	NO	46,00 /pc
		BX-4050		■ min 5 pcs	CR	29,00 /pc	NO	37,00 /pc
		BX-4050		■ min 10 pcs	CR	23,00 /pc	NO	26,00 /pc
B. 109		BX-PT-C57		1 pc	CR	17,30 /pc	NO	19,50 /pc
		BX-PT-C57		■ min 10 pcs	CR	10,70 /pc	NO	11,70 /pc
B. 110		BX-PT-C60		1 pc	CR	17,30 /pc	NO	19,50 /pc
		BX-PT-C60		■ min 10 pcs	CR	10,70 /pc	NO	11,70 /pc
B. 111		BX-PT-C51		1 pc	CR	17,30 /pc	NO	19,50 /pc
		BX-PT-C51		■ min 10 pcs	CR	10,70 /pc	NO	11,70 /pc
B. 112		BX-PT-C52 DX BX-PT-C52 SX		1 pc	CR	17,30 /pc	NO	19,50 /pc
		BX-PT-C52-DX BX-PT-C52-SX		■ min 10 pcs	CR	10,70 /pc	NO	11,70 /pc
B. 113		BX-PT2-C50		1 pc	CR	62,00 /pc		
		BX-PT2-C50		■ min 10 pcs	CR	34,70 /pc		
B. 114		BX-PT3-C50		1 pc	CR	62,00 /pc		
		BX-PT3-C50		■ min 10 pcs	CR	34,70 /pc		
B. 115		BX-C50		1 pc	CR	62,00 /pc		
		BX-C50		■ min 10 pcs	CR	34,70 /pc		
B. 116		BX-PT3-C57 for P-017 pag. 50		1 pc	CR	14,50 /pc		
		BX-PT3-C57-CF10		■ min 10 pcs	CR	10,70 /pc		
B. 117		BX-PT3-C60 for P-017 pag. 50		1 pc	CR	14,50 /pc		
		BX-PT3-C60-CF10		■ min 10 pcs	CR	10,70 /pc		
B. 117.1		V-012-REG		1 pc	CR	33,30 /pc	NS	30,50 /pc
			AN		28,00 /pc			
		V-012-REG		■ min 10 pcs	CR	27,00 /pc	NS	24,70 /pc
			AN		22,30 /pc			

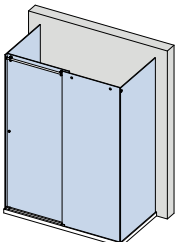
MIX

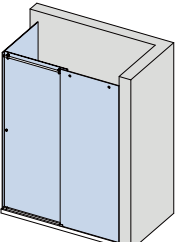
- Minimo ordine 5 pezzi, anche assortiti, fra i vari set
- Minimum order 5 pc also a mixture of different sets
- Mindestbestellmenge: 5 Stück sortiert

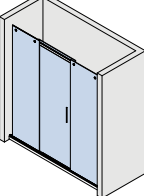
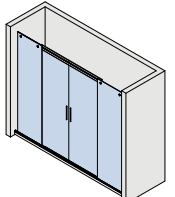
POS.	PROD.	ART.	MIS.	Q.TÀ	FIN.	EURO
	BX-01					▶ BOX DOCCIA 70/77
B. 118		BX-01 SET 1	900x900 mm	1 set	IL	649,50 /set
		BX-01 SET 1 		■ min 5 set	IL	610,70 /set
Inclusi profili a terra / Floor profiles included / Bodenprofile enthalten						
B. 119		BX-01 SET 2	1800 mm	1 set	IL	438,30 /set
		BX-01 SET 2 		■ min 5 set	IL	381,70 /set
Inclusi profili a terra / Floor profiles included / Bodenprofile enthalten						
B. 120		BX-01 SET 3	1800 mm	1 set	IL	447,50 /set
		BX-01 SET 3 		■ min 5 set	IL	385,30 /set
Inclusi profili a terra / Floor profiles included / Bodenprofile enthalten						
B. 121		BX-01 SET 4	1800 mm	1 set	IL	441,70 /set
		BX-01 SET 4 		■ min 5 set	IL	383,50 /set
Inclusi profili a terra / Floor profiles included / Bodenprofile enthalten						
B. 122		BX-01 SET 5	max 2500 mm	1 set	IL	708,50 /set
Inclusi profili a terra / Floor profiles included / Bodenprofile enthalten						
B. 123		BX-01 SET 6	max 2500 mm	1 set	IL	997,00 /set
Inclusi profili a terra / Floor profiles included / Bodenprofile enthalten						



- Confezioni industriali
- Industrial packaging
- Industrieverpackungen

-  **ESEMPIO DI COSTO CON IMBALLO INDUSTRIALE. Confezioni • profili** con quantità fissa, disponibili solo in multipli della quantità indicata.
- **EXAMPLE TOTAL COST WITH COMPONENTS IN INDUSTRIAL PACKAGING. Packs of profiles** with fixed quantity, available only in multiples of the indicated quantity.
- **BEISPIEL GESAMTPREIS MIT INDUSTRIELLER VERPACKUNG. Profilpackungen** mit fixer Menge sind nur als Vielfaches der angeführten Menge erhältlich.

■ **min**

- **Prezzi speciali per l'acquisto delle quantità minime indicate (CF) dell'articolo. NB:** eventuali riordini o aggiunte per completamenti se di quantità inferiore alla minima, saranno fatturati al prezzo normale
- **Special prices for the purchase of the minimum quantities indicated (CF) of the article. Note Well:** any reorders or additions for completions of quantity less than the minimum will be invoiced at the normal price.
- **Artikel mit Sonderpreisen bei Mindestabnahmemengen sind mit (CF) gekennzeichnet. Nachbestellungen oder Ergänzungen unter der Mindestabnahmemenge werden mit dem Normalpreis verrechnet.**



POS.	PROD.	ART.	MIS.	Q.TÀ	FIN.	EURO	
BX-01 <i>COMPONENTI / COMPONENTS / EINZELTEILE</i>							► BOX DOCCIA 78
B. 124		BX-C43-1800	1800 mm	1 pc	IL	196,30 /pc	
		BX-C43-2800	2800 mm	1 pc	IL	227,70 /pc	
		BX-C40-830x830	830x830 mm	2 pc	IL	195,50 /set	
		BX-C43-1800	1800 mm	■ min 5 pcs	IL	102,30 /pc	
		BX-C43-830	830 mm	■ min 6 pcs	IL	62,70 /pc	
B. 125		BX-C10		1 pc	IL	75,70 /pc	
		BX-C10		■ min 10 pcs	IL	46,70 /pc	
B. 126		BX-C70		1 pc	IL	24,00 /pc	
		BX-C70		■ min 10 pcs	IL	11,70 /pc	
B. 127		BX-C90		1 pc	CR	46,30 /pc	
		BX-C90		■ min 10 pcs	CR	23,70 /pc	
B. 128		BX-C30		1 pc	CR	35,00 /pc	
		BX-C30		■ min 10 pcs	CR	19,30 /pc	
B. 129		BX-C20		1 pc	CR	72,30 /pc	
		BX-C20		■ min 10 pcs	CR	55,30 /pc	
B. 130		BX-C80		1 pc	CR	44,00 /pc	
		BX-C80		■ min 10 pcs	CR	25,30 /pc	







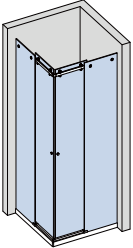
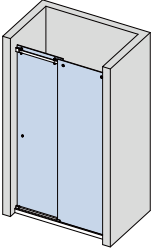
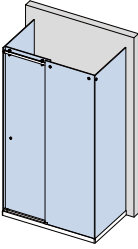
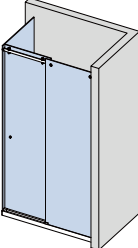

POS.	PROD.	ART.	MIS.	Q.TÀ	FIN.	EURO
B. 131		BX-C50		1 pc	CR	62,00 /pc
		BX-C50		■ min 10 pcs	CR	34,70 /pc
B. 132		BX-C58-1500	1500 mm	1 pc	IL	142,00 /pc
		BX-C58-900	900 mm	1 pc	IL	99,30 /pc
		BX-C55-450	450 mm	1 pc	IL	63,00 /pc
		BX-C58-900	900 mm	■ min 5 pcs	IL	55,70 /pc
B. 133		BX-C60		1 pc	IL	21,30 /pc
		BX-C60		■ min 10 pcs	IL	9,30 /pc
B. 134		BX-C57		1 pc	IL	36,30 /pc
		BX-C57		■ min 10 pcs	IL	22,00 /pc
B. 135		BX-C45		1 pc	CR	20,50 /pc
		BX-C45		■ min 10 pcs	CR	8,00 /pc

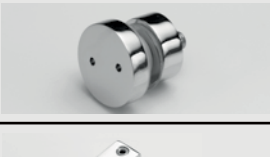
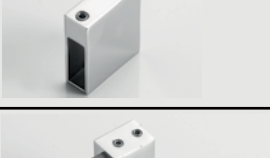
- Confezioni industriali
- Industrial packaging
- Industrieverpackungen

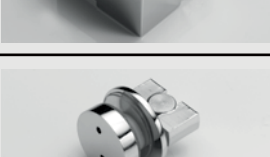
- ⚠ **Confezioni profili** con quantità fissa, disponibili solo in multipli della quantità indicata. Vedi pag. 162
- **Packs of profiles** with fixed quantity, available only in multiples of the indicated quantity. Page 162
- **Profilpackungen** mit fixer Menge sind nur als Vielfaches der angeführten Menge erhältlich. Siehe Seite 162

- **min**
- Prezzi speciali per l'acquisto delle quantità minime indicate (CF) dell'articolo. NB: eventuali riordini o aggiunte per completamenti se di quantità inferiore alla minima, saranno fatturati al prezzo normale
- Special prices for the purchase of the minimum quantities indicated (CF) of the article. Note Well: any reorders or additions for completions of quantity less than the minimum will be invoiced at the normal price.
- Artikel mit Sonderpreisen bei Mindestabnahmemengen sind mit (CF) gekennzeichnet. Nachbestellungen oder Ergänzungen unter der Mindestabnahmemenge werden mit dem Normalpreis verrechnet.

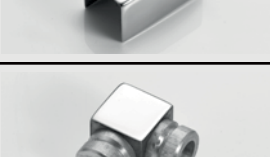
POS.	PROD.	ART.	MIS.	Q.TÀ	FIN.	EURO	
BX-02							▶ BOX DOCCIA 80/85
B. 136		BX-02 SET 1	900x900 mm	1 set	IL	681,30 /set	
		BX-02 SET 1 ⚠		■ min 5 set	IL	611,00 /set	
		Inclusi profili a terra / Floor profiles included / Bodenprofile enthalten					
B. 137		BX-02 SET 2	1800 mm	1 set	IL	482,00 /set	
		BX-02 SET 2 ⚠		■ min 5 set	IL	433,00 /set	
		Inclusi profili a terra / Floor profiles included / Bodenprofile enthalten					
B. 138		BX-02 SET 3	1800 mm	1 set	IL	493,30 /set	
		BX-02 SET 3 ⚠		■ min 5 set	IL	445,00 /set	
		Inclusi profili a terra / Floor profiles included / Bodenprofile enthalten					
B. 139		BX-02 SET 4	1800 mm	1 set	IL	487,70 /set	
		BX-02 SET 4-CF5 ⚠		■ min 5 set	IL	440,00 /set	
		Inclusi profili a terra / Floor profiles included / Bodenprofile enthalten					
BX-02							▶ BOX DOCCIA 86
<i>COMPONENTI / COMPONENTS / EINZELTEILE</i>							
B. 140		BX-Q43-1800	1800 mm	1 pc	IL	217,70 /pc	
		BX-Q43-2500 Senza fori / Without holes / Ohne Bohrungen	2500 mm	1 pc	IL	388,00 /pc	
		BX-Q40-830x830	830x830 mm	2 pc	IL	231,50 /set	
		BX-Q43-1800	1800 mm	■ min 5 pcs	IL	129,50 /pc	
		BX-Q40-830	830 mm	■ min 6 pcs	IL	412,50 /pc	

POS.	PROD.	ART.	MIS.	Q.TÀ	FIN.	EURO
B. 141		BX-Q10		1 pc	CR	79,50 /pc
		BX-Q10		■ min 10 pcs	CR	48,30 /pc
B. 142		BX-Q70		1 pc	CR	28,30 /pc
		BX-Q70		■ min 10 pcs	CR	14,00 /pc
B. 143		BX-Q90		1 pc	CR	50,00 /pc
		BX-Q90		■ min 10 pcs	CR	28,70 /pc
B. 144		BX-Q30		1 pc	CR	42,30 /pc
		BX-Q30		■ min 10 pcs	CR	24,00 /pc
B. 145		BX-Q20		1 pc	CR	46,00 /pc
		BX-Q20		■ min 10 pcs	CR	37,50 /pc
B. 146		BX-Q80		1 pc	CR	43,00 /pc
		BX-Q80		■ min 10 pcs	CR	34,70 /pc
B. 147		BX-C50		1 pc	CR	62,00 /pc
		BX-C50		■ min 10 pcs	CR	34,70 /pc
B. 148		BX-C58-1500	1500 mm	1 pc	IL	142,00 /pc
		BX-C58-900	900 mm	1 pc	IL	99,30 /pc
		BX-C55-450	450 mm	1 pc	IL	63,00 /pc
		BX-C58-900	900 mm	■ min 5 pcs	IL	55,70 /pc
B. 149		BX-C60		1 pc	IL	21,30 /pc
		BX-C60		■ 10 pcs	IL	9,30 /pc
B. 150		BX-C57		1 pc	IL	36,30 /pc
		BX-C57		■ min 10 pcs	IL	22,00 /pc
B.150.1		BX-Q45		1 pcs	CR	26,50 /pc
		BX-Q45-CF10		■ min 10 pcs	CR	15,30 /pc

- Confezioni industriali
- Industrial packaging
- Industrieverpackungen



- **Confezioni profili** con quantità fissa, disponibili solo in multipli della quantità indicata.
- **Packs of profiles** with fixed quantity, available only in multiples of the indicated quantity.
- **Profilpackungen** mit fixer Menge sind nur als Vielfaches der angeführten Menge erhältlich.

■ min

- Prezzi speciali per l'acquisto delle quantità minime indicate (CF) dell'articolo. NB: eventuali riordini o aggiunte per completamenti se di quantità inferiore alla minima, saranno fatturati al prezzo normale
- Special prices for the purchase of the minimum quantities indicated (CF) of the article. Note Well: any reorders or additions for completions of quantity less than the minimum will be invoiced at the normal price.
- Artikel mit Sonderpreisen bei Mindestabnahmemengen sind mit (CF) gekennzeichnet. Nachbestellungen oder Ergänzungen unter der Mindestabnahmemenge werden mit dem Normalpreis verrechnet.

POS.	PROD.	ART.	MIS.	Q.TÀ	FIN.	EURO
------	-------	------	------	------	------	------

BOX DOCCIA SCORREVOLE A SOFFIETTO
SHOWER BOX WITH FOLDING DOOR / DUSCHKABINEN MIT SYSTEM FÜR FALTÜREN





BX-2700	▶ BOX DOCCIA 94/95
----------------	---------------------------

B. 151		<p>BX-2700 SET 2</p> <p>1000 mm</p> <p>1 set</p>	<p>CR 1955,00 /set</p>

B. 152		<p>BX-2700 SET 4 DX</p> <p>1000 mm</p> <p>1 set</p> <p>Apertura Dx Opening Right Öffnung Rechts</p>	<p>CR 1955,00 /set</p>
		<p>BX-2700 SET 4 SX</p> <p>1000 mm</p> <p>1 set</p> <p>Apertura Sx Opening Left Öffnung Links</p>	<p>CR 1955,00 /set</p>

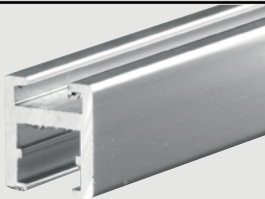
- Indicare sempre il senso di apertura
- Please specify always opening direction
- Bitte immer Öffnungsrichtung angeben

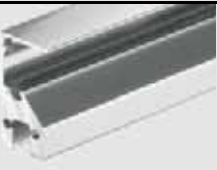
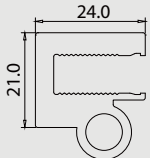
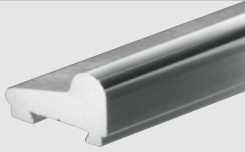
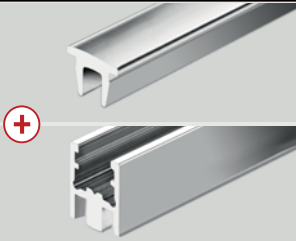
	<p>B-191 B-192 B-193 B-179 B-180</p> <ul style="list-style-type: none"> • Maniglie obbligatorie: vedi pag. 61 • Mandatory handles: see page 61 • Obligatorische Knöpfe und Stossgriffe: siehe Seite 61
--	--

POS.	PROD.	ART.	MIS.	Q.TÀ	FIN.	EURO
BX-2700 COMPONENTI / COMPONENTS / EINZELTEILE						▶ BOX DOCCIA 96/97
B. 153		P-026-1000	1100 mm	1 pc	CR	108,30 /pc
		P-026-2200	2200 mm	1 pc	CR	131,50 /pc
B. 154		BX-2701	2200 mm	1 pc	CR	299,00 /pc
B. 155		BX-2702	2200 mm	1 pc	CR	119,00 /pc
B. 156		BX-2703	2200 mm	1 pc	CR	332,30 /pc
B. 157		BX-2704	2200 mm	1 pc	CR	231,50 /pc
B. 158		BX-2711	2200 mm	1 pc	CR	177,30 /pc
B. 159		P-017	2100 mm	1 pc	CR	50,70 /pc
		P-017-MIX	2100 mm	min 5 pcs	CR	33,30 /pc
B. 160		BX-PT58/56-CF1	1500 mm	1 pc	CR	66,30 /set
B. 161		BX-2706		1 pc		61,00 /pc

- Confezioni industriali
- Industrial packaging
- Industrieverpackungen

■ **min**

- Prezzi speciali per l'acquisto delle quantità minime indicate (CF) dell'articolo. NB: eventuali riordini o aggiunte per completamenti se di quantità inferiore alla minima, saranno fatturati al prezzo normale
- Special prices for the purchase of the minimum quantities indicated (CF) of the article. Note Well: any reorders or additions for completions of quantity less than the minimum will be invoiced at the normal price.
- Artikel mit Sonderpreisen bei Mindestabnahmemengen sind mit (CF) gekennzeichnet. Nachbestellungen oder Ergänzungen unter der Mindestabnahmemenge werden mit dem Normalpreis verrechnet.

POS.	PROD.	ART.	MIS.	Q.TÀ	FIN.	EURO
B. 162		P-019	2200 mm	1 pc	CR	66,30 /pc
		P-019-MIX	2200 mm	min 5 pcs	CR	46,30 /pc
B. 163		L-220		1 pc	CR	257,30 /pc
		L-220		■ min 10 pcs	CR	229,30 /pc
B. 164		BX-2707-DX		1 pc	CR	91,50 /pc
B. 165		BX-2707-SX		1 pc	CR	91,50 /pc
B. 166		BX-2708-DX		1 pc	CR	82,30 /pc
B. 167		BX-2708-SX		1 pc	CR	82,30 /pc
B. 168		BX-2709-DX		1 pc	CR	85,00 /pc
B. 169		BX-2709-SX		1 pc	CR	85,00 /pc
B. 170		BX-2710-DX		1 pc	CR	79,00 /pc
B. 171		BX-2710-SX		1 pc	CR	79,00 /pc

MIX

- Minimo ordine: 5 pezzi, anche assortiti fra i vari profili
- Minimum order: 5 pieces, also for combinations of various profiles
- Mindestbestellmenge: 5 Stück, auch sortiert nach verschiedenen Profilen









POS.	PROD.	ART.	Q.TÀ	FIN.	EURO
BX-2600					► BOX DOCCIA 100/101
B. 172		BX-2600 SET 2	1 set	CR	847,00 /set
B. 173		BX-2600 SET 4	1 set	CR	942,50 /set
B. 174		<p>L-219</p> <ul style="list-style-type: none"> • da incollare al vetro • to be glued on glass • auf das Glas kleben 	<p>A</p> <p>Apertura a Sx/Left/Links</p> <p>B</p> <p>Apertura a Dx/Right/Rechts</p> <p>C</p> <p>Apertura a Sx/Left/Links</p> <p>D</p> <p>Apertura a Dx/Right/Rechts</p>	<ul style="list-style-type: none"> • Indicare sempre il senso di apertura • Please specify always opening direction • Bitte immer Öffnungsrichtung angeben 	
		OPTIONALS	<ul style="list-style-type: none"> • Pomoli e maniglie vedi pag. 61-66 • Knobs and pullhandles page 61-66 • Knöpfe und Stosgriffe siehe Seite 61-66 		

MIX

- Minimo ordine: 5 pezzi, anche assortiti fra i vari profili
- Minimum order: 5 pieces, also for combinations of various profiles
- Mindestbestellmenge: 5 Stück, auch sortiert nach verschiedenen Profilen

MIS

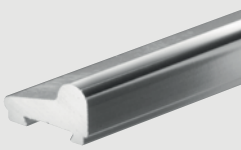
- Tagliato a misura del cliente
- Custom length
- Nach Mass geschnitten

POS.	PROD.	ART.	MIS.	Q.TÀ	FIN.	EURO
BX-2600 COMPONENTI / COMPONENTS / EINZELTEILE						▶ BOX DOCCIA 102/103
B. 175		B-502 DX-S		1 pc	CR	98,30 /pc
					NS	98,30 /pc
B. 176		B-502 SX-S		1 pc	CR	98,30 /pc
					NS	98,30 /pc
B. 177		B-501 DX-S		1 pc	CR	92,70 /pc
					NS	92,70 /pc
B. 178		B-501 SX-S		1 pc	CR	92,70 /pc
					NS	92,70 /pc
B. 179		L-217		1 pc	CR	175,70 /pc
		L-217-MIS 	1000 → 1200 mm	1 pc	CR	253,70 /pc
B. 180		P-017	2100 mm	1 pc	CR	50,70 /pc
		P-017-MIX	2100 mm	min 5 pcs	CR	33,30 /pc
B. 181		L-219		1 pc		65,00 /pc
B. 182		BX-2601		2 pc	CR	150,00 /set

POS.	PROD.	ART.	MIS.	Q.TÀ	FIN.	EURO
B. 183		BX-2602 DX		1 pc	CR	161,50 /pc
B. 184		BX-2602 SX		1 pc	CR	161,50 /pc
B. 185		BX-2603 DX		1 pc	CR	263,00 /pc
B. 186		BX-2603 SX		1 pc	CR	263,00 /pc
B. 187		B-147-8	2200 mm	1 pc		34,30 /pc
		B-147-8-MIX	2200 mm	min 5 pcs		20,30 /pc
B. 188		B-145-8	2500 mm	1 pc		32,00 /pc
		B-145-8-MIX	2500 mm	min 5 pcs		18,70 /pc
B. 189		WRU-C-BUMP-MT12	12 mt	1 pc		247,30 /pc 20,61 /mt

MIX

- Minimo ordine: 5 pezzi, anche assortiti fra i vari profili
- Minimum order: 5 pieces, also for combinations of various profiles
- Mindestbestellmenge: 5 Stück, auch sortiert nach verschiedenen Profilen

POS.	PROD. / ART.	MIS.	Q.TÀ	FIN.	EURO
------	--------------	------	------	------	------

PIVOT ALTO-BASSO (BILICO) PORTA BATTENTE
TOP/BOTTOM PIVOT HINGES / OBERE/UNTERE PIVOT BÄNDER

BX-2100 ▶ BOX DOCCIA 122/125



B. 190	<p>BX-2100 SET 2</p>	1100 mm	1 set	CR 1038,00 /set
--------	-----------------------------	---------	-------	------------------------

B. 191	<p>BX-2100 SET 4</p>	1100 mm	1 set	CR 1038,00 /set
--------	-----------------------------	---------	-------	------------------------

B. 192		OPTIONALS	<ul style="list-style-type: none"> • Pomoli e maniglie vedi pag. 61-66 • Knobs and pullhandles page 61-66 • Knöpfe und Stossgriffe siehe Seite 61-66
--------	--	------------------	---

BX-2100 ▶ BOX DOCCIA 126
COMPONENTI / COMPONENTS / EINZELTEILE

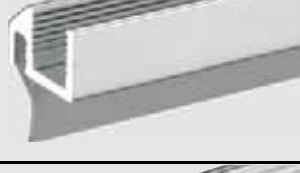

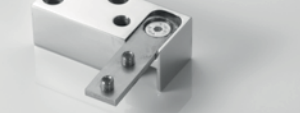



B. 193		P-026-1000	1100 mm	1 pc	CR 108,30 /pc
		P-026-2200	2200 mm	1 pc	CR 131,50 /pc

POS.	PROD.	ART.	MIS.	Q.TÀ	FIN.	EURO
B. 194		P-018-M	2200 mm	1 pc	CR	123,30 /pc
		P-018-M-MIX	2200 mm	min 5 pcs	CR	95,50 /pc
B. 195		P-018-B	2200 mm	1 pc	CR	84,30 /pc
		P-018-B-MIX	2200 mm	min 5 pcs	CR	61,50 /pc
B. 196		P-018-V	2200 mm	1 pc	CR	109,00 /pc
		P-018-V-MIX	2200 mm	min 5 pcs	CR	91,30 /pc
B. 197		P-019	2200 mm	1 pc	CR	66,30 /pc
		P-019-MIX	2200 mm	min 5 pcs	CR	46,30 /pc
B. 198		R-30-1000	1100 mm	1 pc	CR	114,00 /pc
		R-30-2200	2200 mm	1 pc	CR	146,00 /pc
B. 199		B-304		1 pc	CR	143,70 /pc
B. 200		P-F11		1 pc		70,70 /pc
B. 201		P-F12		1 pc		95,30 /pc
B. 202		P-F09		1 pc	CR	79,50 /pc
B. 203		P-F13		1 pc	CR	79,50 /pc

- Confezioni industriali
- Industrial packaging
- Industrieverpackungen







■ **min**

- Prezzi speciali per l'acquisto delle quantità minime indicate (CF) dell'articolo. NB: eventuali riordini o aggiunte per completamenti se di quantità inferiore alla minima, saranno fatturati al prezzo normale
- Special prices for the purchase of the minimum quantities indicated (CF) of the article. Note Well: any reorders or additions for completions of quantity less than the minimum will be invoiced at the normal price.
- Artikel mit Sonderpreisen bei Mindestabnahmemengen sind mit (CF) gekennzeichnet. Nachbestellungen oder Ergänzungen unter der Mindestabnahmemenge werden mit dem Normalpreis verrechnet.

POS.	PROD.	ART.	Q.TÀ	FIN.	EURO	FIN.	EURO	FIN.	EURO
BOX DOCCIA CON ANTA A BATTENTE <i>SHOWER BOX WITH SWING DOOR / DUSCHKABINEN MIT DREH-TÜR</i>									
CERNIERE A SCATTO ▶ BOX DOCCIA 106/113 - 128/131 <i>DOUBLE ACTION CLICKING HINGES / SELBSTSCHLIESSENDE PENDELTÜRBÄNDER</i>									
B. 204		B-701	1 pc	CR	163,00 /pc	NS	165,70 /pc	CP	172,30 /pc
		B-701	■ min 20 pcs	CR	144,30 /pc	NS	146,00 /pc	CP	151,00 /pc
B. 205		B-702	1 pc	CR	228,00 /pc	NS	231,00 /pc	CP	233,30 /pc
		B-702	■ min 20 pcs	CR	205,70 /pc	NS	208,30 /pc	CP	213,30 /pc
B. 206		B-305	1 pc	CR	173,50 /pc	NS	178,00 /pc	CP	207,30 /pc
		B-305	■ min 20 pcs	CR	157,70 /pc	NS	161,50 /pc	CP	192,30 /pc
B. 207		B-100	1 pc	CR	74,30 /pc	NS	74,30 /pc	NO	94,30 /pc
		B-100	■ min 30 pcs	CR	62,70 /pc	NS	62,70 /pc	NO	85,00 /pc
B. 208		B-101	1 pc	CR	74,30 /pc	NS	74,30 /pc	NO	94,30 /pc
		B-101	■ min 30 pcs	CR	62,70 /pc	NS	62,70 /pc	NO	85,00 /pc
B. 209		B-102	1 pc	CR	106,50 /pc	NS	106,50 /pc	NO	124,50 /pc
		B-102	■ min 20 pcs	CR	93,70 /pc	NS	93,70 /pc	NO	116,70 /pc
B. 210		B-103	1 pc	CR	106,50 /pc	NS	106,50 /pc		
		B-103	■ min 20 pcs	CR	93,70 /pc	NS	93,70 /pc		

MIX

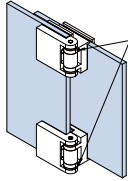
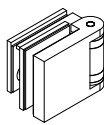
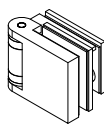







- Minimo ordine: 5 pezzi, anche assortiti fra i vari profili
- Minimum order: 5 pieces, also for combinations of various profiles
- Mindestbestellmenge: 5 Stück, auch sortiert nach verschiedenen Profilen

POS.	PROD.	ART.	Q.TÀ	FIN.	EURO	FIN.	EURO	FIN.	EURO
B. 211		B-150	1 pc	CR	98,00 /pc	NS	99,70 /pc		
		B-150	■ min 30 pcs	CR	85,30 /pc	NS	87,30 /pc		
B. 212		B-301	1 pc	CR	99,70 /pc	NS	99,70 /pc		
		B-301	■ min 20 pcs	CR	85,00 /pc	NS	85,00 /pc		
B. 213		B-306	1 pc	CR	125,30 /pc	NS	125,30 /pc		
		B-306	■ min 20 pcs	CR	115,00 /pc	NS	115,00 /pc		
B. 214		B-303 DX B-303 SX	1 pc	CR	156,70 /pc				
		B-303 DX B-303 SX	■ min 20 pcs	CR	123,30 /pc				
		 <ul style="list-style-type: none"> • Ordinare sempre 1 pezzo DX + 1 pezzo SX • To order always 1 pc DX + 1 pc SX • Bestellung immer 1 Stück DX + 1 Stück SX  							
B. 215		L-220	1 pc	CR	257,30 /pc	NS	257,30 /pc	CP	257,30 /pc
		L-220	■ min 10 pcs	CR	229,30 /pc	NS	229,30 /pc	CP	229,30 /pc
B. 216		B-400	1 pc	CR	46,00 /pc	NS	46,00 /pc		
		B-400-CF30	■ min 30 pcs	CR	37,70 /pc	NS	37,70 /pc		

-
- Confezioni industriali
 - Industrial packaging
 - Industrieverpackungen

■ **min**

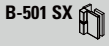
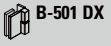
- Prezzi speciali per l'acquisto delle quantità minime indicate (CF) dell'articolo. NB: eventuali riordini o aggiunte per completamenti se di quantità inferiore alla minima, saranno fatturati al prezzo normale
- Special prices for the purchase of the minimum quantities indicated (CF) of the article. Note Well: any reorders or additions for completions of quantity less than the minimum will be invoiced at the normal price.
- Artikel mit Sonderpreisen bei Mindestabnahmemengen sind mit (CF) gekennzeichnet. Nachbestellungen oder Ergänzungen unter der Mindestabnahmemenge werden mit dem Normalpreis verrechnet.

POS.	PROD.	ART.	Q.TÀ	FIN.	EURO	FIN.	EURO	FIN.	EURO
B. 217		B-401	1 pc	CR	46,00 /pc	NS	46,00 /pc		
		B-401	■ min 20 pcs	CR	37,70 /pc	NS	37,70 /pc		
B. 218		B-402	1 pc	CR	60,00 /pc	NS	60,00 /pc		
		B-402	■ min 20 pcs	CR	50,00 /pc	NS	50,00 /pc		
B. 219		B-405	1 pc	CR	60,00 /pc	NS	60,00 /pc		
		B-405	■ min 20 pcs	CR	50,00 /pc	NS	50,00 /pc		
CERNIERE A SCATTO IN BATTUTA SINGLE ACTION CLICKING HINGES FOR CONTINUOUS SEALS / ANSCHLAGTÜRBÄNDER FÜR DURCHGEHENDE DICHTUNG (SELBSTSCHLIESSENDE BÄNDER)								▶ BOX DOCCIA 114/115	
B. 220		B-201	1 pc	CR	103,00 /pc	NS	103,00 /pc		
		B-201	■ min 20 pcs	CR	91,70 /pc	NS	91,70 /pc		
B. 221		B-202	1 pc	CR	143,30 /pc	NS	143,30 /pc		
		B-202	■ min 20 pcs	CR	133,70 /pc	NS	133,70 /pc		
CERNIERE CON ALZATA IN APERTURA HINGES WITH LIFT-LOWER FUNCTION / BÄNDER MIT HEBE-SENK-FUNKTION								▶ BOX DOCCIA 116/117	
B. 222	  B-501 SX  B-501 DX 	B-501 DX B-501 SX	1 pc	CR	72,50 /pc	NS	72,50 /pc		
		B-501 DX B-501 SX	■ min 20 pcs	CR	55,70 /pc	NS	55,70 /pc		

POS.	PROD.	ART.	Q.TÀ	FIN.	EURO	FIN.	EURO	FIN.	EURO
B. 223		B-502 DX B-502 SX	1 pc	CR	90,00 /pc	NS	90,00 /pc		
		B-502 DX B-502 SX	■ min 20 pcs	CR	68,50 /pc	NS	68,50 /pc		

CERNIERE LIBERE IN BATTUTA

SINGLE ACTION HINGES FOR CONTINUOUS SEALS / ANSCHLAGTÜRBÄNDER FÜR DURCHGEHENDE DICHTUNG

► BOX DOCCIA 118/120

B. 224		B-711	1 pc	CR	82,00 /pc				
		B-711	■ min 20 pcs	CR	59,50 /pc				
B. 225		B-712	1 pc	CR	99,70 /pc				
		B-712	■ min 20 pcs	CR	75,70 /pc				
B. 226		B-105	1 pc	CR	86,30 /pc	NS	86,30 /pc		
		B-105	■ min 20 pcs	CR	72,30 /pc	NS	72,30 /pc		
B. 227		B-104	1 pc	CR	98,70 /pc	NS	98,70 /pc		
		B-104	■ min 20 pcs	CR	84,00 /pc	NS	84,00 /pc		
B. 228		B-601 DX B-601 SX	1 pc	CR	75,00 /pc	NS	75,00 /pc		
		B-601 DX B-601 SX	■ min 20 pcs	CR	57,00 /pc	NS	57,00 /pc		
B. 229		B-602 DX B-602 SX	1 pc	CR	83,00 /pc	NS	83,00 /pc		
		B-602 DX B-602 SX	■ min 20 pcs	CR	64,30 /pc	NS	64,30 /pc		

-
- Confezioni industriali
 - Industrial packaging
 - Industrieverpackungen

■ **min**

- Prezzi speciali per l'acquisto delle quantità minime indicate (CF) dell'articolo. NB: eventuali riordini o aggiunte per completamenti se di quantità inferiore alla minima, saranno fatturati al prezzo normale
- Special prices for the purchase of the minimum quantities indicated (CF) of the article. Note Well: any reorders or additions for completions of quantity less than the minimum will be invoiced at the normal price.
- Artikel mit Sonderpreisen bei Mindestabnahmemengen sind mit (CF) gekennzeichnet. Nachbestellungen oder Ergänzungen unter der Mindestabnahmemenge werden mit dem Normalpreis verrechnet.

POS.	PROD.	ART.	MIS.	Q.TÀ	FIN.	EURO	FIN.	EURO
PROFILI DI BATTUTA						▶ BOX DOCCIA 134/137-144		
<i>DOOR STOP PROFILES / TÜRANSCHLAGSPROFILE</i>								
B. 230		P-015	2200 mm	1 pc	CR	114,00 /pc		
		P-015-MIX	2200 mm	min 5 pcs	CR	75,70 /pc		
		P-015-M	2200 mm	1 pc	CR	124,50 /pc		
		P-015-M-MIX	2200 mm	min 5 pcs	CR	99,70 /pc		
B. 231		P-016	2200 mm	1 pc	CR	73,30 /pc		
		P-016-MIX	2200 mm	min 5 pcs	CR	56,50 /pc		
B. 232		P-018-M	2200 mm	1 pc	CR	123,30 /pc		
		P-018-M-MIX	2200 mm	min 5 pcs	CR	95,50 /pc		
B. 233		P-018-B	2200 mm	1 pc	CR	84,30 /pc		
		P-018-B-MIX	2200 mm	min 5 pcs	CR	61,50 /pc		
B. 234		P-018-V	2200 mm	1 pc	CR	109,00 /pc		
		P-018-V-MIX	2200 mm	min 5 pcs	CR	91,30 /pc		
B. 235		BX-PF-01	2200 mm	1 pc	CR	105,30 /pc	NO	132,00 /pc
		BX-PF-01-MIX	2200 mm	min 5 pcs	CR	74,30 /pc	NO	93,00 /pc
								BX-PT-C58

MIX



- Minimo ordine: 5 pezzi, anche assortiti fra i vari profili
- Minimum order: 5 pieces, also for combinations of various profiles
- Mindestbestellmenge: 5 Stück, auch sortiert nach verschiedenen Profilen

POS.	PROD.	ART.	MIS.	Q.TÀ	FIN.	EURO	FIN.	EURO
B. 236		P-027	2200 mm	1 pc	CR	64,30 /pc		
		P-027-MIX	2200 mm	min 5 pcs	CR	41,30 /pc		
B. 237		P-027-M	2200 mm	1 pc	CR	73,30 /pc		
		P-027-M-MIX	2200 mm	min 5 pcs	CR	53,00 /pc		

PROFILI E GOCCIOLATOI

SPLASH GUARD PROFILES / SCHWALLSCHUTZPROFILE

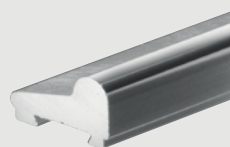
► BOX DOCCIA 136/139

B. 238		P-017	2200 mm	1 pc	CR	50,70 /pc		
		P-017-MIX	2200 mm	min 5 pcs	CR	33,30 /pc		
B. 116		BX-PT3-C57		1 pc	CR	14,50 /pc		
		BX-PT3-C57		■ min 10 pcs	CR	10,70 /pc		
B. 117		BX-PT3-C60			CR	14,50 /pc		
		BX-PT3-C60		■ min 10 pcs	CR	10,70 /pc		
B. 239		P-019	2200 mm	1 pc	CR	66,30 /pc		
		P-019-MIX	2200 mm	min 5 pcs	CR	46,30 /pc		



- Confezioni industriali
- Industrial packaging
- Industrieverpackungen



- **Confezioni profili** con quantità fissa, disponibili solo in multipli della quantità indicata.
- **Packs of profiles** with fixed quantity, available only in multiples of the indicated quantity.
- **Profilpackungen** mit fixer Menge sind nur als Vielfaches der angeführten Menge erhältlich.

CF

- Prezzi speciali per l'acquisto delle quantità minime indicate (CF) dell'articolo. NB: eventuali riordini o aggiunte per completamenti se di quantità inferiore alla minima, saranno fatturati al prezzo normale
- Special prices for the purchase of the minimum quantities indicated (CF) of the article. Note Well: any reorders or additions for completions of quantity less than the minimum will be invoiced at the normal price.
- Artikel mit Sonderpreisen bei Mindestabnahmemengen sind mit (CF) gekennzeichnet. Nachbestellungen oder Ergänzungen unter der Mindestabnahmemenge werden mit dem Normalpreis verrechnet.

POS.	PROD.	ART.	MIS.	Q.TÀ	FIN.	EURO	FIN.	EURO	FIN.	EURO
CANALINE U PROFILES / U-PROFILE										
CANALINE "U" IN ALLUMINIO U PROFILES IN ALUMINIUM / U-PROFILE AUS ALUMINIUM								▶ BOX DOCCIA 140/141		
B. 240		V-2036-MIX	3000 mm	min 5 pcs mix	CR	94,70 /pc	IXE	106,50 /pc	AN	97,00 /pc
		V-2036-CF8 ⚠	3000 mm	8 pcs	CR	92,09 /pc 736,70 /8 pc	IXE	103,79 /pc 830,30 /8 pc	AN	94,41 /pc 755,30 /8 pc
		V-2036-T	Tappo Endcap Endkappe	1 pc	IL	16,30 /pc	IX	18,70 /pc	AN	16,30 /pc
B. 241		V-2037-MIX	3000 mm	min 5 pcs mix	CR	93,70 /pc	IXE	103,00 /pc	AN	96,00 /pc
		V-2037-CF8 ⚠	3000 mm	8 pcs	CR	91,21 /pc 729,70 /8 pc	IXE	100,38 /pc 803,00 /8 pc	AN	93,25 /pc 746,00 /8 pc
		V-2037-T	Tappo Endcap Endkappe	1 pc	IL	16,30 /pc	IX	18,70 /pc	AN	16,30 /pc
B. 242		V-2038-MIX	3000 mm	min 5 pcs mix	CR	70,70 /pc	IXE	74,30 /pc	AN	68,50 /pc
		V-2038-CF10 ⚠	3000 mm	10 pcs	CR	68,03 /pc 680,30 /10 pcs	IXE	71,70 /pc 717,00 /10 pcs	AN	64,57 /pc 645,70 /10 pcs
		V-2038-T	Tappo Endcap Endkappe	1 pc	IL	14,30 /pc	IX	16,30 /pc	AN	13,30 /pc
B. 243		V-2039-MIX	3000 mm	min 5 pcs mix	CR	68,50 /pc	IXE	72,30 /pc	AN	64,70 /pc
		V-2039-CF10 ⚠	3000 mm	10 pcs	CR	65,07 /pc 650,70 /10 pcs	IXE	68,80 /pc 688,00 /10 pcs	AN	61,13 /pc 611,30 /10 pcs
		V-2039-T	Tappo Endcap Endkappe	1 pc	IL	14,30 /pc	IX	16,30 /pc	AN	13,30 /pc

MIX

- Minimo ordine: 5 pezzi, anche assortiti fra i vari profili e guarnizioni
- Minimum order: 5 pieces, also for combinations of various profiles and gaskets
- Mindestbestellmenge: 5 Stück, auch sortiert nach verschiedenen Profilen und Dichtungen

■ min

- Prezzi speciali per l'acquisto delle quantità minime indicate (CF) dell'articolo. NB: eventuali riordini o aggiunte per completamenti se di quantità inferiore alla minima, saranno fatturati al prezzo normale
- Special prices for the purchase of the minimum quantities indicated (CF) of the article. Note Well: any reorders or additions for completions of quantity less than the minimum will be invoiced at the normal price.
- Artikel mit Sonderpreisen bei Mindestabnahmemengen sind mit (CF) gekennzeichnet. Nachbestellungen oder Ergänzungen unter der Mindestabnahmemenge werden mit dem Normalpreis verrechnet.

POS.	PROD.	ART.	MIS.	Q.TÀ	FIN.	EURO	FIN.	EURO	FIN.	EURO
B. 244		V-2040-MIX	3000 mm	min 5 pcs mix	CR	46,70/pc	IXE	46,70/pc	AN	35,00/pc
		V-2040-CF14	3000 mm	14 pcs	CR	41,88/pc 586,30/14 pcs	IXE	41,88/pc 586,30/14 pcs	AN	30,64/pc 429,00/14 pcs
		V-2040-T	Tappo Endcap Endkappe	1 pc	IL	14,30/pc	IX	16,30/pc	AN	13,30/pc
B. 245		V-2041-MIX	3000 mm	min 5 pcs mix	CR	45,70/pc	IXE	45,70/pc	AN	34,30/pc
		V-2041-CF14	3000 mm	14 pcs	CR	41,31/pc 578,30/14 pcs	IXE	41,31/pc 578,30/14 pcs	AN	29,84/pc 417,70/14 pcs
		V-2041-T	Tappo Endcap Endkappe	1 pc	IL	14,30/pc	IX	16,30/pc	AN	13,30/pc
B. 246		B-138-MIX	3000 mm	min 5 pcs mix	CR	47,30/pc	AN	41,00/pc		
		B-138-CF10	3000 mm	10 pcs	CR	43,93/pc 439,30/10 pcs	AN	37,33/pc 373,30/10 pcs		
B. 247		B-137-MIX	3000 mm	min 5 pcs mix	CR	46,70/pc	AN	39,70/pc		
		B-137-CF10	3000 mm	10 pcs	CR	42,80/pc 428,00/10 pcs	AN	35,93/pc 359,30/10 pcs		
B. 248		B-136-MIX	3000 mm	min 5 pcs mix	CR	42,30/pc	NO	54,70/pc		
		B-136-CF12	3000 mm	12 pcs	CR	38,19/pc 458,30/12 pcs	NO	50,83/pc 610,00/12 pcs		
B. 249		BX-PT-C58/56 CF1	1 pc BX-PT-C58 (1500 mm) + 1 pc BX-PT-C56 (1500 mm)		CR	66,30/set	NO	90,00/set		
		BX-PT-C58/56 CF2	1 pc BX-PT-C58 (1500 mm) + 1 pc BX-PT-C58 (3000 mm) + 1 pc BX-PT-C56 (1500 mm)		CR	118,50/set	NO	149,30/set		
		BX-C58/56 CF1 3M	1 pc BX-PT-C58 (3000 mm) + 1 pc BX-PT-C56 (3000 mm)		CR	106,00/set	NO	143,70/set		
		BX-C58/56 CF2 3M	2 pc BX-PT-C58 (3000 mm) + 1 pc BX-PT-C56 (3000 mm)		CR	138,00/set	NO	175,00/set		
B. 250		BX-PT-C58 MIX	3000 mm	min 5 pcs mix	CR	50,00/pc	NO	74,00/pc		
		BX-PT-C58-CF12	3000 mm	12 pcs	CR	45,53/pc 546,30/12 pcs	NO	69,39/pc 832,70/12 pcs		

- Confezioni industriali
- Industrial packaging
- Industrieverpackungen

- Confezioni profili** con quantità fissa, disponibili solo in multipli della quantità indicata.
- **Packs of profiles** with fixed quantity, available only in multiples of the indicated quantity.
- **Profilpackungen** mit fixer Menge sind nur als Vielfaches der angeführten Menge erhältlich.

MIX

- Minimo ordine: 5 pezzi, anche assortiti fra i vari profili e guarnizioni
- Minimum order: 5 pieces, also for combinations of various profiles and gaskets
- Mindestbestellmenge: 5 Stück, auch sortiert nach verschiedenen Profilen und Dichtungen

POS.	PROD.	ART.	MIS.	Q.TÀ	FIN.	EURO	FIN.	EURO	FIN.	EURO
B. 251		BX-PT-C56 MIX	3000 mm	min 5 pcs mix	CR	37,30/pc	NO	54,30/pc		
		BX-PT-C56-CF8 ⚠	3000 mm	8 pc	CR	33,63/pc 269,00 / 8 pc	NO	47,84/pc 382,70 / 8 pc		
B. 252		B-136-C60	Tappo Endcap Endkappe	2 pc	CR	11,30/set				
B. 253		BX-PF-01	2200 mm	1 pc	CR	105,30/pc	NO	132,00/pc		
		BX-PF-01-MIX	2200 mm	min 5 pcs mix	CR	74,30/pc	NO	93,00/pc		
B. 254		BX-PF-02	2200 mm	1 pc	CR	98,30/pc	NO	123,00/pc		
		BX-PF-02-MIX	2200 mm	min 5 pcs mix	CR	70,70/pc	NO	88,70/pc		

CANALINE "U" INOX SPIGOLO VIVO										► BOX DOCCIA 142
<i>U PROFILES / U-PROFILE</i>										
B. 255		V-2021-MIX	2500 mm	min 5 pcs mix	IX	49,30/pc	IL	51,00/pc		
		V-2021-CF10 ⚠	2500 mm	10 pcs	IX	45,53/pc 455,30 / 10 pcs	IL	47,40/pc 474,00 / 10 pcs		
B. 256		V-2020-MIX	2500 mm	min 5 pcs mix	IX	47,30/pc	IL	49,30/pc		
		V-2020-CF10 ⚠	2500 mm	10 pcs	IX	43,60/pc 436,00 / 10 pcs	IL	45,53/pc 455,30 / 10 pcs		
B. 257		V-2016-MIX	2500 mm	min 5 pcs mix	IX	45,70/pc	IL	46,70/pc		
		V-2016-CF10 ⚠	2500 mm	10 pcs	IX	41,87/pc 418,70 / 10 pcs	IL	42,80/pc 428,00 / 10 pcs		
B. 258		V-2017-MIX	2500 mm	min 5 pcs mix	IX	45,30/pc	IL	46,30/pc		
		V-2017-CF10 ⚠	2500 mm	10 pcs	IX	41,33/pc 413,30 / 10 pcs	IL	42,47/pc 424,70 / 10 pcs		
B. 259		V-2019-MIX	2500 mm	min 5 pcs mix	IX	44,00/pc	IL	45,30/pc		
		V-2019-CF10 ⚠	2500 mm	10 pcs	IX	40,50/pc 405,00 / 10 pcs	IL	41,33/pc 413,30 / 10 pcs		

CF

- Prezzi speciali per l'acquisto delle quantità minime indicate (CF) dell'articolo. NB: eventuali riordini o aggiunte per completamenti se di quantità inferiore alla minima, saranno fatturati al prezzo normale
- Special prices for the purchase of the minimum quantities indicated (CF) of the article. Note Well: any reorders or additions for completions of quantity less than the minimum will be invoiced at the normal price.
- Artikel mit Sonderpreisen bei Mindestabnahmemengen sind mit (CF) gekennzeichnet. Nachbestellungen oder Ergänzungen unter der Mindestabnahmemenge werden mit dem Normalpreis verrechnet.

MIX

- Minimo ordine: 5 pezzi, anche assortiti fra i vari profili in acciaio inox
- Minimum order: 5 pieces, also for combinations of various stainless steel profiles
- Mindestbestellmenge: 5 Stück, auch sortiert nach verschiedenen Edelstahl Profilen

POS.	PROD.	ART.	MIS.	Q.TÀ	FIN.	EURO	FIN.	EURO	FIN.	EURO
CANALINE "U" BORDO RIPIEGATO										
<i>U PROFILES WITH FOLDED EDGE / U-PROFILE MIT ABGERUNDETER KANTE</i>										
► BOX DOCCIA 142										
B. 260		V-2030-MIX	2500 mm	min 5 pcs mix	IX	77,50/pc	IL	75,00/pc		
		V-2030-CF10 ⚠	2500 mm	10 pcs	IX	73,40/pc 734,00/10 pcs	IL	71,10/pc 711,00/10 pcs		
B. 261		V-2016-R-MIX	2500 mm	min 5 pcs mix	IX	71,50/pc	IL	76,00/pc		
		V-2016-R-CF10 ⚠	2500 mm	10 pcs	IX	68,03/pc 680,30/10 pcs	IL	72,25/pc 722,50/10 pcs		
B. 262		V-2017-R-MIX	2500 mm	min 5 pcs mix	IX	71,50/pc	IL	74,00/pc		
		V-2017-R-CF10 ⚠	2500 mm	10 pcs	IX	67,10/pc 671,00/10 pcs	IL	70,33/pc 703,30/10 pcs		
B. 263		V-2029-MIX	2500 mm	min 5 pcs mix	IX	69,50/pc	IL	71,50/pc		
		V-2029-CF10 ⚠	2500 mm	10 pcs	IX	65,73/pc 657,30/10 pcs	IL	67,67/pc 676,70/10 pcs		
ANGOLARI										
<i>L PROFILES / L-PROFILE</i>										
► BOX DOCCIA 143										
B. 264		V-2025-MIX	2500 mm	min 5 pcs mix	IX	51,70/pc	IL	51,70/pc		
		V-2025-CF10 ⚠	2500 mm	10 pcs	IX	47,60/pc 476,00/10 pcs	IL	47,60/pc 476,00/10 pcs		
B. 265		V-2024-MIX	2500 mm	min 5 pcs mix	IX	38,00/pc	IL	38,50/pc		
		V-2024-CF10 ⚠	2500 mm	10 pcs	IX	34,40/pc 344,00/10 pcs	IL	34,77/pc 347,70/10 pcs		
B. 266		V-2023-MIX	2500 mm	min 5 pcs mix	IX	35,30/pc	IL	36,30/pc		
		V-2023-CF10 ⚠	2500 mm	10 pcs	IX	31,33/pc 313,30/10 pcs	IL	32,13/pc 321,30/10 pcs		
B. 267		V-2022-MIX	2500 mm	min 5 pcs mix	IX	34,30/pc	IL	34,30/pc		
		V-2022-CF10 ⚠	2500 mm	10 pcs	IX	29,05/pc 290,50/10 pcs	IL	29,05/pc 290,50/10 pcs		

- Confezioni industriali
- Industrial packaging
- Industrieverpackungen

- ⚠ **Confezioni profili** con quantità fissa, disponibili solo in multipli della quantità indicata.
- **Packs of profiles** with fixed quantity, available only in multiples of the indicated quantity.
- **Profilpackungen** mit fixer Menge sind nur als Vielfaches der angeführten Menge erhältlich.

CF

- Prezzi speciali per l'acquisto delle quantità minime indicate (CF) dell'articolo. NB: eventuali riordini o aggiunte per completamenti se di quantità inferiore alla minima, saranno fatturati al prezzo normale
- Special prices for the purchase of the minimum quantities indicated (CF) of the article. Note Well: any reorders or additions for completions of quantity less than the minimum will be invoiced at the normal price.
- Artikel mit Sonderpreisen bei Mindestabnahmemengen sind mit (CF) gekennzeichnet. Nachbestellungen oder Ergänzungen unter der Mindestabnahmemenge werden mit dem Normalpreis verrechnet.

POS.	PROD.	ART.	MIS.	Q.TÀ	FIN.	EURO	FIN.	EURO	FIN.	EURO
CANALINE CON ALETTA LATERALE <i>U PROFILES WITH SIDE PLATE / U-PROFILE MIT SEITLICHER PLATTE</i> ▶ BOX DOCCIA 143										
B. 268		V-2028-MIX	2500 mm	min 5 pcs mix	IX	107,70/pc	IL	107,70/pc		
		V-2028-CF10	2500 mm	10 pcs	IX	104,70/pc 1047,00/10 pcs	IL	104,70/pc 1047,00/10 pcs		
B. 269		V-2027-MIX	2500 mm	min 5 pcs mix	IX	109,50/pc	IL	109,50/pc		
		V-2027-CF10	2500 mm	10 pcs	IX	106,33/pc 1063,30/10 pcs	IL	106,33/pc 1063,30/10 pcs		
B. 270		V-2026-MIX	2500 mm	min 5 pcs mix	IX	102,50/pc	IL	104,00/pc		
		V-2026-CF10	2500 mm	10 pcs	IX	99,80/pc 998,00/10 pcs	IL	100,93/pc 1009,30/10 pcs		
CANALINE CON ALETTA <i>U PROFILES WITH PLATE / U-PROFILE MIT PLATTE</i> ▶ BOX DOCCIA 143										
B. 271		V-2033-MIX	2500 mm	min 5 pcs mix	IX	106,50/pc	IL	106,50/pc		
		V-2033-CF10	2500 mm	10 pcs	IX	103,80/pc 1038,00/10 pcs	IL	103,80/pc 1038,00/10 pcs		
B. 272		V-2032-MIX	2500 mm	min 5 pcs mix	IX	104,70/pc	IL	104,70/pc		
		V-2032-CF10	2500 mm	10 pcs	IX	102,05/pc 1020,50/10 pcs	IL	102,05/pc 1020,50/10 pcs		
B. 273		V-2031-MIX	2500 mm	min 5 pcs mix	IX	104,00/pc	IL	104,00/pc		
		V-2031-CF10	2500 mm	10 pcs	IX	100,93/pc 1009,30/10 pcs	IL	100,93/pc 1009,30/10 pcs		
B. 274		V-2018	2000 mm	1 pc	IL	67,50/pc				
		V-2018-MIX	2000 mm	min 5 pcs mix	IL	59,50/pc				
B. 275		V-GUARD-2018	2000 mm	1 pc	IL	23,00/pc				
		V-GUARD-2018-MIX	2000 mm	min 5 pcs mix	IL	17,00/pc				
B. 276		V-GUARD-2016	2000 mm	1 pc	IL	29,50/pc				
		V-GUARD-2016-MIX	2000 mm	min 5 pcs mix	IL	22,30/pc				

MIX







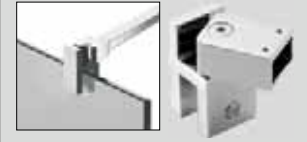

- Minimo ordine: 5 pezzi, anche assortiti fra i vari profili in acciaio inox
- Minimum order: 5 pieces, also for combinations of various stainless steel profiles
- Mindestbestellmenge: 5 Stück, auch sortiert nach verschiedenen Edelstahl Profilen

POS.	PROD.	ART.	MIS.	Q.TÀ	FIN.	EURO	FIN.	EURO	FIN.	EURO
BARRE DI SUPPORTO <i>SUPPORT BARS / STABILISATIONSSTANGEN</i>										
BARRE DI SUPPORTO QUADRE REGOLABILI <i>ADJUSTABLE SQUARE SUPPORT BARS / VERSTELLBARE ECKIGE STABILISATIONSSTANGEN</i>										► BOX DOCCIA 148/153
B. 277		B-328-500	500 mm	1 pc	CR	151,00 /pc	NS	162,50 /pc	NO	206,70 /pc
		B-328-500	500 mm	■ min 10 pcs	CR	108,50 /pc	NS	116,30 /pc		
		B-328-1000	1000 mm	1 pc	CR	175,70 /pc	NS	188,70 /pc	NO	227,30 /pc
		B-328-1000	1000 mm	■ min 10 pcs	CR	135,30 /pc	NS	144,30 /pc		
		B-328-1500	1500 mm	1 pc	IL	191,30 /pc	NO	250,30 /pc		
		B-328-1500	1500 mm	■ min 10 pcs	IL	147,50 /pc				
B. 278		B-328-F-500	500 mm	1 pc	CR	126,70 /pc	NS	136,30 /pc	NO	178,00 /pc
		B-328-F-500	500 mm	■ min 10 pcs	CR	107,30 /pc	NS	114,30 /pc		
		B-328-F-1000	1000 mm	1 pc	CR	153,00 /pc	NS	164,00 /pc	NO	198,70 /pc
		B-328-F-1000	1000 mm	■ min 10 pcs	CR	133,30 /pc	NS	142,70 /pc		
		B-328-F-1500	1500 mm	1 pc	IL	188,70 /pc	NO	244,50 /pc		
		B-328-F-1500	1500 mm	■ min 10 pcs	IL	136,30 /pc				
B. 279		B-318-500	500 mm	1 pc	CR	40,30 /pc	NS	49,00 /pc		
		B-318-500	500 mm	■ min 10 pcs	CR	30,50 /pc	NS	36,30 /pc		
		B-318-1000	1000 mm	1 pc	CR	68,50 /pc	NS	75,00 /pc		
		B-318-1000	1000 mm	■ min 10 pcs	CR	52,00 /pc	NS	62,30 /pc		
		B-318-1500	1500 mm	1 pc	IL	91,00 /pc				
		B-318-1500	1500 mm	■ min 10 pcs	IL	56,30 /pc				

-
- Confezioni industriali
 - Industrial packaging
 - Industrieverpackungen

■ **min**

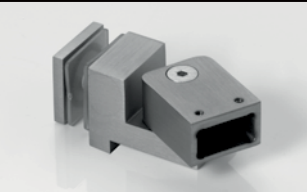
- Prezzi speciali per l'acquisto delle quantità minime indicate (CF) dell'articolo. NB: eventuali riordini o aggiunte per completamenti se di quantità inferiore alla minima, saranno fatturati al prezzo normale
- Special prices for the purchase of the minimum quantities indicated (CF) of the article. Note Well: any reorders or additions for completions of quantity less than the minimum will be invoiced at the normal price.
- Artikel mit Sonderpreisen bei Mindestabnahmemengen sind mit (CF) gekennzeichnet. Nachbestellungen oder Ergänzungen unter der Mindestabnahmemenge werden mit dem Normalpreis verrechnet.









POS.	PROD.	ART.	MIS.	Q.TÀ	FIN.	EURO	FIN.	EURO	FIN.	EURO
B. 280		B-319		1 pc	CR	68,50 /pc	NS	78,00 /pc		
		B-319		■ min 10 pcs	CR	44,30 /pc	NS	53,50 /pc		
B. 281		B-320		1 pc	CR	59,00 /pc	NS	72,30 /pc		
		B-320		■ min 10 pcs	CR	40,70 /pc	NS	48,30 /pc		
B. 282		B-321		1 pc	CR	41,70 /pc	NS	48,30 /pc		
		B-321		■ min 10 pcs	CR	35,30 /pc	NS	41,00 /pc		
B. 283		B-322		1 pc	CR	38,50 /pc	NS	44,30 /pc		
		B-322		■ min 10 pcs	CR	34,30 /pc	NS	39,70 /pc		
B. 284		B-323		1 pc	CR	47,00 /pc	NS	54,30 /pc		
		B-323		■ min 10 pcs	CR	43,00 /pc	NS	51,70 /pc		
B. 285		B-324		1 pc	CR	38,50 /pc	NS	44,30 /pc		
		B-324		■ min 10 pcs	CR	34,30 /pc	NS	39,70 /pc		
B. 286		B-325		1 pc	CR	69,70 /pc	NS	80,70 /pc		
B. 287		B-326		1 pc	CR	88,00 /pc	NS	99,70 /pc		
B. 288		B-327		1 pc	CR	105,30 /pc	NS	123,70 /pc		

POS.	PROD.	ART.	MIS.	Q.TÀ	FIN.	EURO	FIN.	EURO	FIN.	EURO
BARRE DI SUPPORTO QUADRE										► BOX DOCCIA 154
<i>SQUARE SUPPORT BARS / ECKIGE STABILISATIONSSTANGEN</i>										
B. 289		B-511-220	220 mm	1 pc	CR	95,50 /pc	NS	95,50 /pc		
		B-511-220	220 mm	■ min 10 pcs	CR	74,30 /pc	NS	74,30 /pc		
B. 290		B-511-370	370 mm	1 pc	CR	102,00 /pc	NS	102,00 /pc		
		B-511-370	370 mm	■ min 10 pcs	CR	79,30 /pc	NS	79,30 /pc		
B. 291		B-521	1200 mm	1 pc	CR	111,30 /pc	NS	111,30 /pc		
		B-521	1200 mm	■ min 10 pcs	CR	88,70 /pc	NS	88,70 /pc		
B. 292		B-529	1200 mm	1 pc	CR	55,30 /pc	NS	55,30 /pc		
		B-529	1200 mm	■ min 10 pcs	CR	44,00 /pc	NS	44,00 /pc		
B. 293		B-528		1 pc	CR	30,30 /pc	NS	30,30 /pc		
		B-528		■ min 10 pcs	CR	20,50 /pc	NS	20,50 /pc		
B. 294		B-527		1 pc	CR	44,30 /pc	NS	44,30 /pc		
		B-527		■ min 10 pcs	CR	34,30 /pc	NS	34,30 /pc		
B. 295		B-523		1 pc	CR	100,70 /pc				
		B-523		■ min 10 pcs	CR	76,50 /pc				

- Confezioni industriali
- Industrial packaging
- Industrieverpackungen

■ **min**

- Prezzi speciali per l'acquisto delle quantità minime indicate (CF) dell'articolo. NB: eventuali riordini o aggiunte per completamenti se di quantità inferiore alla minima, saranno fatturati al prezzo normale
- Special prices for the purchase of the minimum quantities indicated (CF) of the article. Note Well: any reorders or additions for completions of quantity less than the minimum will be invoiced at the normal price.
- Artikel mit Sonderpreisen bei Mindestabnahmemengen sind mit (CF) gekennzeichnet. Nachbestellungen oder Ergänzungen unter der Mindestabnahmemenge werden mit dem Normalpreis verrechnet.







POS.	PROD.	ART.	MIS.	Q.TÀ	FIN.	EURO	FIN.	EURO	FIN.	EURO
BARRE DI SUPPORTO TONDE										
<i>ROUND SUPPORT BARS / RUNDE STABILISATIONSSTANGEN</i>										
► BOX DOCCIA 155/157										
B. 296		B-160	450 mm	1 pc	CR	78,00 /pc	NS	78,00 /pc		
		B-160	450 mm	■ min 10 pcs	CR	58,00 /pc	NS	58,00 /pc		
B. 297		B-161	1200 mm	1 pc	CR	84,30 /pc	NS	84,30 /pc		
		B-161	1200 mm	■ min 10 pcs	CR	66,30 /pc	NS	66,30 /pc		
B. 298		B-162	1200 mm	1 pc	CR	94,70 /pc	NS	94,70 /pc		
		B-162	1200 mm	■ min 10 pcs	CR	71,30 /pc	NS	71,30 /pc		
B. 299		B-171	1200 mm	1 pc	CR	86,30 /pc	NS	86,30 /pc		
		B-171	1200 mm	■ min 10 pcs	CR	64,70 /pc	NS	64,70 /pc		
B. 300		B-175	1200 mm	1 pc	IL	43,30 /pc	IX	43,30 /pc		
		B-175	1200 mm	■ min 10 pcs	IL	29,50 /pc	IX	29,50 /pc		
B. 301		B-176	2000 mm	1 pc	IL	63,70 /pc	IX	63,70 /pc		
		B-176	2000 mm	■ min 10 pcs	IL	46,00 /pc	IX	46,00 /pc		
B. 302		B-174		1 pc	CR	32,00 /pc	NS	32,00 /pc		
		B-174		■ min 10 pcs	CR	20,30 /pc	NS	20,30 /pc		
B. 303		B-185		1 pc	IL	38,50 /pc	IX	38,50 /pc		
		B-185		■ min 10 pcs	IL	25,50 /pc	IX	25,50 /pc		





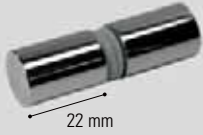

POS.	PROD.	ART.	MIS.	Q.TÀ	FIN.	EURO	FIN.	EURO	FIN.	EURO
B. 304		B-172		1 pc	CR	36,30 /pc	NS	36,30 /pc		
B. 305		B-166		1 pc	CR	41,30 /pc	NS	41,30 /pc		
B. 306		B-167		1 pc	CR	42,30 /pc	NS	42,30 /pc		
B. 307		B-163		1 pc	CR	49,30 /pc	NS	49,30 /pc		
B. 308		B-164		1 pc	CR	63,00 /pc	NS	63,00 /pc		
B. 309		B-165		1 pc	CR	63,00 /pc	NS	63,00 /pc		
B. 309.1		B-184		1 pc	CR	38,50 /pc	NS	[FUN] /pc		
B. 310		B-173		1 pc	CR	81,70 /pc	NS	81,70 /pc		
B. 311		B-181		1 pc	CR	67,00 /pc	NS	67,00 /pc		
B. 312		B-185-S		1 pc	CR	85,30 /pc				
B. 313		B-189	1200 mm	1 pc	CR	136,30 /pc				

- Confezioni industriali
- Industrial packaging
- Industrieverpackungen

min

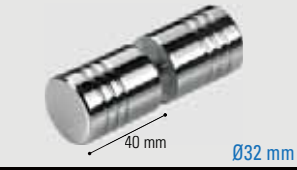
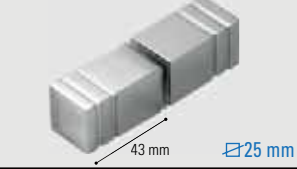
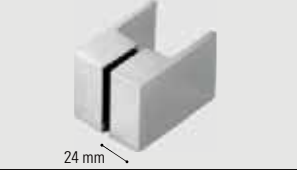
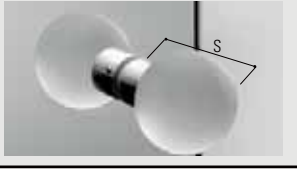
- Prezzi speciali per l'acquisto delle quantità minime indicate (CF) dell'articolo. NB: eventuali riordini o aggiunte per completamenti se di quantità inferiore alla minima, saranno fatturati al prezzo normale
- Special prices for the purchase of the minimum quantities indicated (CF) of the article. Note Well: any reorders or additions for completions of quantity less than the minimum will be invoiced at the normal price.
- Artikel mit Sonderpreisen bei Mindestabnahmemengen sind mit (CF) gekennzeichnet. Nachbestellungen oder Ergänzungen unter der Mindestabnahmemenge werden mit dem Normalpreis verrechnet.

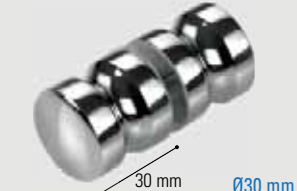





POS.	PROD.	ART.	MIS.	Q.TÀ	FIN.	EURO	FIN.	EURO
POMOLI, NICCHIE E MANIGLIONI						▶ BOX DOCCIA 172/175		
<i>KNOBBS, SLIDING HANDLE AND PULLHANDLES / KNÖPFE, RUND GRIFFMUSCHEL UND STOSSGRIFFE</i>								
B. 314	 35 mm Ø28 mm	B-168	Ø 28 mm	1 pair	CR NS CP	29,50 /pair	NO	41,30 /pair
		B-168	Ø 28 mm	■ min 10 pairs	CR NS CP	23,00 /pair	NO	32,00 /pair
B. 315	 33 mm Ø28 mm	B-169	28 x 28 mm	1 pair	CR	51,00 /pair		
		B-169	28 x 28 mm	■ min 10 pairs	CR	43,50 /pair		
B. 316	 22 mm Ø15 mm	B-177	Ø 15 x 22 mm	1 pair	IL	69,70 /pair	IX	69,70 /pair
		B-177	Ø 15 x 22 mm	■ min 10 pairs	IL	59,50 /pair	IX	59,50 /pair
B. 317	 22 mm Ø15 mm	B-178	Ø 15 x 22 mm	1 pair	IL	88,70 /pair	IX	88,70 /pair
		B-178	Ø 15 x 22 mm	■ min 10 pairs	IL	68,30 /pair	IX	68,30 /pair
B. 318	 19 mm FINE SERIE END OF SERIES AUSLAUFMODELL	B-179	93 mm	1 pc	CS	88,00 /pc	CR	88,00 /pc
B. 319	 18 mm FINE SERIE END OF SERIES AUSLAUFMODELL	B-180	45 mm	1 pc	CS	64,50 /pc	CR	64,50 /pc
B. 320		B-191-80	80 x H 28 mm	1 pair	CR	62,30 /pair		
		B-191-240	240 x H 28 mm	1 pair	CR	71,50 /pair		

POS.	PROD.	ART.	MIS.	Q.TÀ	FIN.	EURO	FIN.	EURO
B. 321		B-192	Ø 29 x 15 mm	1 pair	CR	55,30 /pair		
B. 322		B-193	H 25 x 62 mm	1 pair	CR	79,30 /pair		
B. 323		B-194	Ø 32 x 40 mm	1 pair	CR	45,30 /pair	NS	45,30 /pair
		B-194	Ø 32 x 40 mm	■ min 10 pairs	CR	38,70 /pair	NS	38,70 /pair
B. 324		B-195	Ø 25 x 43 mm	1 pair	CR	51,00 /pair	NS	51,00 /pair
		B-195	Ø 25 x 43 mm	■ min 10 pairs	CR	43,50 /pair	NS	43,50 /pair
B. 325		B-197	70 x H 50 mm	1 pair	CR	95,50 /pair		
		B-197	70 x H 50 mm	■ min 10 pairs	CR	83,30 /pair		
B. 326		V-019	Ø 40 mm - S 52 mm	1 pair		111,30 /pair		
		V-019	Ø 45 mm - S 57 mm	1 pair		126,70 /pair		
		V-019	Ø 50 mm - S 62 mm	1 pair		142,30 /pair		
B. 327		V-024 25	Ø 25 x 25 mm	1 pair	CR	37,00 /pair	NS	37,00 /pair
B. 328		V-024 30	Ø 30 x 30 mm	1 pair	CR	37,70 /pair	NS	37,70 /pair
		V-024 30	Ø 30 x 30 mm	■ min 10 pairs	CR	30,50 /pair	NS	30,50 /pair
B. 329		V-024 32	Ø 32 x 32 mm	1 pair	CR	48,30 /pair	NS	48,30 /pair
		V-024 32	Ø 32 x 32 mm	■ 10 pairs	CR	41,50 /pair	NS	41,50 /pair

- Confezioni industriali
- Industrial packaging
- Industrieverpackungen

■ **min**

- Prezzi speciali per l'acquisto delle quantità minime indicate (CF) dell'articolo. NB: eventuali riordini o aggiunte per completamenti se di quantità inferiore alla minima, saranno fatturati al prezzo normale
- Special prices for the purchase of the minimum quantities indicated (CF) of the article. Note Well: any reorders or additions for completions of quantity less than the minimum will be invoiced at the normal price.
- Artikel mit Sonderpreisen bei Mindestabnahmemengen sind mit (CF) gekennzeichnet. Nachbestellungen oder Ergänzungen unter der Mindestabnahmemenge werden mit dem Normalpreis verrechnet.

POS.	PROD.	ART.	MIS.	Q.TÀ	FIN.	EURO	FIN.	EURO
B. 330	 Ø38 mm	V-024 38	Ø 38 x 38 mm	1 pair	CR	69,70 /pair	NS	64,70 /pair
B. 331	 35 mm	V-1107	35 x 35 mm	1 pair	CR	42,50 /pair		
		V-1107	35 x 35 mm	■ min 10 pairs	CR	36,50 /pair		
B. 332	 Ø55 mm	B-170	Ø 55 mm	1 pair	CR	68,50 /pair		
		B-170	Ø 55 mm	■ min 10 pairs	CR	56,50 /pair		
B. 333	 Ø40 mm	V-526	Ø 40 mm	1 pair	CR	54,30 /pair	NS	55,70 /pair
		V-526	Ø 40 mm	■ min 10 pairs	CR	42,00 /pair	NS	43,50 /pair
B. 334	 Ø30 mm	V-528	Ø 30 mm	1 pair	CR	50,70 /pair	NS	50,70 /pair
B. 334.1	 Ø59 mm	V-524	Ø 59 mm	1 pair	CP NS	60,00 /pair	CR	55,70 /pair
		V-524	Ø 59 mm	■ min 10 pairs	CP NS	47,50 /pair	CR	44,70 /pair

POS.	PROD.	ART.	MIS.	Q.TÀ	FIN.	EURO	FIN.	EURO
MANIGLIONI MINI INOX "ROUND MINI Ø 16"						► BOX DOCCIA 177		
<i>PULLHANDLES MINI INOX / STOSSGRIFFE MINI INOX</i>								
B. 335		16.02.13/135.225	Ø 16 mm TL = 225 mm A = 135 mm ☒ = 9 mm 🔩 = M 5	1 pair	IX	67,00/pair		
				■ min 10 pairs	IX	47,00/pair		
		16.02.53/135.225	Ø 16 mm TL = 225 mm A = 135 mm ☒ = 9 mm 🔩 = M 5	1 pair	IL	78,50/pair		
				■ min 10 pairs	IL	57,00/pair		
		16.02.13/200.300	Ø 16 mm TL = 300 mm A = 200 mm ☒ = 9 mm 🔩 = M 5	1 pair	IX	69,30/pair		
				■ min 10 pairs	IX	49,00/pair		
		16.02.53/200.300	Ø 16 mm TL = 300 mm A = 200 mm ☒ = 9 mm 🔩 = M 5	1 pair	IL	83,00/pair		
				■ min 10 pairs	IL	60,00/pair		
B. 336		B-177	Ø 15 x 22 mm	1 pair	IL	69,70/pair	IX	69,70/pair
		B-177-CF10	Ø 15 x 22 mm	■ min 10 pairs	IL	59,50/pair	IX	59,50/pair
<ul style="list-style-type: none"> • Possibilità di utilizzo con maniglioni "MINI" D.16 montati su box doccia set 1 per evitare contatto all'interno. Per questa versione è necessario ordinare due paia di pomoli ed 1 paio di maniglioni mini • Possible to use with Mini pullhandles D.16 for Set 1 shower system to avoid the contact of the handles in the inside. For this version it's necessary to order one pair Mini pullhandles and two pairs knobs • Mini Um den Kontakt der Beschläge auf der Innenseite des Duschsystem Set1 zu vermeiden, ist es notwendig ein Paar Mini Stossgriffe D.16 und 2 Paar Mini Knöpfe zu verwenden 								
MANIGLIONI "ZAMA"						► BOX DOCCIA 178		
<i>PULLHANDLES ZAMAK / STOSSGRIFFE ZAMAK</i>								
B. 337		SQ01	Ø 16 mm TL = 200 mm A = 160 mm ☒ = 6 mm 🔩 = M 4	1 pair	CR	73,00/pair		
		SQ02	Ø 16 mm TL = 200 mm A = 160 mm ☒ = 6 mm 🔩 = M 4	1 pc	CR	63,30/pc		

- Confezioni industriali
- Industrial packaging
- Industrieverpackungen

■ **min**

- Prezzi speciali per l'acquisto delle quantità minime indicate (CF) dell'articolo. NB: eventuali riordini o aggiunte per completamenti se di quantità inferiore alla minima, saranno fatturati al prezzo normale
- Special prices for the purchase of the minimum quantities indicated (CF) of the article. Note Well: any reorders or additions for completions of quantity less than the minimum will be invoiced at the normal price.
- Artikel mit Sonderpreisen bei Mindestabnahmemengen sind mit (CF) gekennzeichnet. Nachbestellungen oder Ergänzungen unter der Mindestabnahmemenge werden mit dem Normalpreis verrechnet.

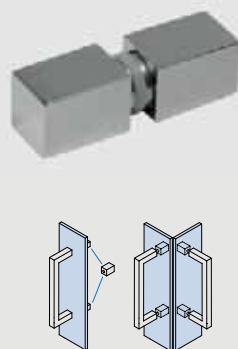
POS.	PROD.	ART.	MIS.	Q.TÀ	FIN.	EURO	FIN.	EURO
MANIGLIONI MINI INOX "SQUARE MINI 15"						▶ BOX DOCCIA 177		
<i>PULLHANDLES MINI INOX / STOSSGRIFFE MINI INOX</i>								
B. 338 		15.41.13/135.50	□ 15 mm TL = 150 mm A = 135 mm □ = 9 mm 🔩 = M 5	1 pair	IX	79,50/pair		
				■ min 10 pairs	IX	57,70/pair		
		15.41.53/135.150	□ 15 mm TL = 150 mm A = 135 mm □ = 9 mm 🔩 = M 5	1 pair	IL	84,30/pair		
				■ min 10 pairs	IL	61,50/pair		
		15.41.13/200.215	□ 15 mm TL = 215 mm A = 200 mm □ = 9 mm 🔩 = M 5	1 pair	IX	80,70/pair		
				■ min 10 pairs	IX	59,30/pair		
		15.41.53/200.215	□ 15 mm TL = 215 mm A = 200 mm □ = 9 mm 🔩 = M 5	1 pair	IL	88,70/pair		
				■ min 10 pairs	IL	67,50/pair		
		15.41.13/300.315	□ 15 mm TL = 315 mm A = 300 mm □ = 9 mm 🔩 = M 5	1 pair	IX	83,00/pair		
				■ min 10 pairs	IX	62,30/pair		
		15.41.53/300.315	□ 15 mm TL = 315 mm A = 300 mm □ = 9 mm 🔩 = M 5	1 pair	IL	95,50/pair		
				■ min 10 pairs	IL	73,50/pair		
B. 339 		B-178	□ 15 x 22 mm	1 pair	CR	88,70/pair	NS	88,70/pair
		B-178	□ 15 x 22mm	■ min 10 pairs	CR	68,30/pair	NS	68,30/pair
<ul style="list-style-type: none"> • Possibilità di utilizzo con maniglioni "MINI" Q.15 montati su box doccia set 1 per evitare contatto all'interno. • Per questa versione è necessario ordinare due paia di pomoli ed 1 paio di maniglioni mini • Possible to use with Mini pullhandles Q.15 for Set 1 shower system to avoid the contact of the handles in the inside. • For this version it's necessary to order one pair Mini pullhandles and two pairs knobs Mini • Um den Kontakt der Beschläge auf der Innenseite des Duschsystem Set1 zu vermeiden, ist es notwendig ein Paar Mini Stossgriffe Q.15 und 2 Paar Mini Knöpfe zu verwenden 								

POS.	PROD.	ART.	MIS.	Q.TÀ	FIN.	EURO	FIN.	EURO		
MANIGLIONI "SQUARE 10"						► BOX DOCCIA 177				
<i>PULLHANDLES SQUARE 10 / STOSSGRIFFE SQUARE 10</i>										
B. 340		10.41.53/290.300	10 x 15 mm TL = 300 mm A = 290 mm 8 mm	1 pair ■ min 10 pairs	CR CR	108,00/pair 79,30/pair	Ottone Brass Messing			
		10.41.63/290.300	10 x 15 mm TL = 300 mm A = 290 mm 8 mm	1 pair ■ min 10 pairs	AL AL	60,00/pair 38,50/pair	Alluminio CR effect Aluminium CR effect Aluminium CR effect			
		10.41.73/290.300	10 x 15 mm TL = 300 mm A = 290 mm 8 mm	1 pair ■ min 10 pairs	NO NO	66,30/pair 40,00/pair	Alluminio Aluminium Aluminium			
		10.41.53/490.500	10 x 15 mm TL = 500 mm A = 490 mm 8 mm	1 pair ■ min 10 pairs	CR CR	143,50/pair 110,00/pair	Ottone Brass Messing			
		10.41.63/490.500	10 x 15 mm TL = 500 mm A = 490 mm 8 mm	1 pair ■ min 10 pairs	AL AL	61,50/pair 46,00/pair	Alluminio CR effect Aluminium CR effect Aluminium CR effect			
		PORTA SALVIETTA						► BOX DOCCIA 178/179		
		<i>TOWEL BAR / HANDTUCHHALTER</i>								
		B. 341		B-120	Ø 25 - 600 mm	1 pc	CR	108,70/pc		
		B. 342		B-121	Ø 25 - 600 mm	1 pc	CR	141,30/pc		
		B. 343		B-122	Ø 25 x 30 mm	1 pc	CR	23,00/pc		
B. 344		B-124	19x19 mm TL = 419 mm A = 450 mm 10 mm	1 pc	IL	115,00/pc				
		B-125	19x19 mm TL = 619 mm A = 600 mm 10 mm	1 pc	IL	132,00/pc				
B. 345		B-186	15 x 40 mm	1 pc	CR	54,30/pc				

- Confezioni industriali
- Industrial packaging
- Industrieverpackungen

■ **min**

- Prezzi speciali per l'acquisto delle quantità minime indicate (CF) dell'articolo. NB: eventuali riordini o aggiunte per completamenti se di quantità inferiore alla minima, saranno fatturati al prezzo normale
- Special prices for the purchase of the minimum quantities indicated (CF) of the article. Note Well: any reorders or additions for completions of quantity less than the minimum will be invoiced at the normal price.
- Artikel mit Sonderpreisen bei Mindestabnahmemengen sind mit (CF) gekennzeichnet. Nachbestellungen oder Ergänzungen unter der Mindestabnahmemenge werden mit dem Normalpreis verrechnet.

POS.	PROD.	ART.	MIS.	Q.TÀ	FIN.	EURO	FIN.	EURO
MORSETTI E RAGNETTI						▶ BOX DOCCIA 160/165		
<i>CLAMPS AND CONNECTORS / KLEMMBESCHLÄGE UND VERBINDER</i>								
B. 346		B-152-40	40 x 40 mm	1 pc	CR	55,70 /pc	NS	58,30 /pc
		B-152-40	40 x 40 mm	■ min 10 pcs	CR	43,30 /pc	NS	45,70 /pc
B. 347		B-153-40	40 x 40 mm	1 pc	CR	70,00 /pc	NS	72,50 /pc
		B-153-40	40 x 40 mm	■ min 10 pcs	CR	55,30 /pc	NS	58,00 /pc
B. 348		B-154-40	40 x 40 mm	1 pc	CR	47,00 /pc	NS	49,30 /pc
		B-154-40	40 x 40 mm	■ min 10 pcs	CR	37,00 /pc	NS	38,70 /pc
B. 349		B-155-40	40 x 40 mm	1 pc	CR	47,00 /pc	NS	49,30 /pc
		B-155-40	40 x 40 mm	■ min 10 pcs	CR	37,00 /pc	NS	38,70 /pc
B. 350		B-156-40	40 x 40 mm	1 pc	CR	54,70 /pc	NS	57,30 /pc
		B-156-40	40 x 40 mm	■ 10 pcs	CR	43,00 /pc	NS	45,30 /pc
B. 351		B-157-40	40 x 84 mm	1 pc	CR	53,50 /pc	NS	57,30 /pc
		B-157-40	40 x 84 mm	■ 10 pcs	CR	42,30 /pc	NS	44,00 /pc
B. 352		B-158-40	40 x 84 mm	1 pc	CR	68,30 /pc	NS	72,50 /pc
		B-158-40	40 x 84 mm	■ 10 pcs	CR	54,30 /pc	NS	56,50 /pc

POS.	PROD.	ART.	MIS.	Q.TÀ	FIN.	EURO	FIN.	EURO
B. 353		B-159-50	50 x 50 mm	1 pc	CR	64,30 /pc		
		B-159-50	50 x 50 mm	■ min10 pcs	CR	51,00 /pc		
B. 354		B-160-50	50 x 50 mm	1 pc	CR	80,00 /pc		
		B-160-50	50 x 50 mm	■ min 10 pcs	CR	63,30 /pc		
B. 355		B-182	56 x 40 mm	1 pc	CR	67,00 /pc	NS	70,00 /pc
		B-182	56 x 40 mm	■ min 10 pcs	CR	53,00 /pc	NS	55,70 /pc
B. 356		B-183	56 x 40 mm	1 pc	CR	83,00 /pc	NS	86,00 /pc
		B-183	56 x 40 mm	■ min 10 pcs	CR	66,30 /pc	NS	69,50 /pc
B. 357		B-187	56 x 84 mm	1 pc	CR	64,70 /pc	NS	67,50 /pc
		B-187	56 x 84 mm	■ min 10 pcs	CR	51,00 /pc	NS	53,70 /pc
B. 358		B-188	56 x 84 mm	1 pc	CR	81,30 /pc	NS	83,30 /pc
		B-188	56 x 84 mm	■ min 10 pcs	CR	66,30 /pc	NS	69,50 /pc
B. 359		B-110	35 x 80 mm	1 pc	CR	56,50 /pc	NS	56,50 /pc
B. 360		B-111	35 x 80 mm	1 pc	CR	56,50 /pc	NS	56,50 /pc

- Confezioni industriali
- Industrial packaging
- Industrieverpackungen

■ **min**

- Prezzi speciali per l'acquisto delle quantità minime indicate (CF) dell'articolo. NB: eventuali riordini o aggiunte per completamenti se di quantità inferiore alla minima, saranno fatturati al prezzo normale
- Special prices for the purchase of the minimum quantities indicated (CF) of the article. Note Well: any reorders or additions for completions of quantity less than the minimum will be invoiced at the normal price.
- Artikel mit Sonderpreisen bei Mindestabnahmemengen sind mit (CF) gekennzeichnet. Nachbestellungen oder Ergänzungen unter der Mindestabnahmemenge werden mit dem Normalpreis verrechnet.









POS.	PROD.	ART.	MIS.	Q.TÀ	FIN.	EURO	FIN.	EURO
B. 361		B-16		1 pc	IX	81,70 /pc	IL	81,70 /pc
B. 362		B-17		1 pc	IX	84,30 /pc	IL	84,30 /pc
B. 363		B-20		1 pc	IX	50,70 /pc	IL	50,70 /pc
B. 364		B-21		1 pc	IX	53,70 /pc	IL	53,70 /pc
B. 365		B-25		1 pc	IX	56,50 /pc	IL	56,50 /pc
B. 366		B-30		1 pc	IX	59,50 /pc	IL	59,50 /pc
B. 367		B-35		1 pc	IX	75,00 /pc	IL	75,00 /pc
B.367.1		PG-CHIAVE		1 pc		41,70 /pc		

POS.	PROD.	ART.	MIS.		Q.TÀ	FIN.	EURO
GUARNIZIONI DOCCE <i>SHOWER GASKETS / DICHTUNGEN</i>							▶ BOX DOCCIA 166/171
B. 368		B-116-8-MIX	2500 mm	8 mm	min 5 pcs mix		23,00 /pc
		B-116-8-MIX	2500 mm	8 mm	■ min 10 pcs		20,00 /pc
B. 369		B-118-8-MIX	2500 mm	8 mm	min 5 pcs mix		24,70 /pc
		B-118-8-MIX	2500 mm	8 mm	■ min 10 pcs		21,00 /pc
B. 370		B-115-25-MIX	2500 mm	8 mm	min 5 pcs mix		24,00 /kit
		B-115-25-MIX	2500 mm	8 mm	■ min 10 pcs		20,50 /pc
B. 371		B-115-20-MIX	2500 mm	8 mm	min 5 pcs mix		20,50 /pc
		B-115-20-MIX	2500 mm	8 mm	■ min 10 pcs		17,00 /pc
B. 372		B-142-8-MIX	2500 mm	8 mm	min 5 pcs mix		52,50 /pc
		B-142-8-MIX	2500 mm	8 mm	■ min 10 pcs		49,30 /pc
B. 373		B-144-8-MIX	2500 mm	8 mm	min 5 pcs mix		52,50 /pc
		B-144-8-MIX	2500 mm	8 mm	■ min 10 pcs		49,30 /pc
B. 374		B-119-8-MIX	2500 mm	8 mm	min 5 pcs mix		28,30 /pc
		B-119-8-MIX	2500 mm	8 mm	■ min 10 pcs		24,50 /pc
B. 375		B-117-8-MIX	2500 mm	8 mm	min 5 pcs mix		23,50 /pc
		B-117-8-MIX	2500 mm	8 mm	■ min 10 pcs		20,00 /pc

- Confezioni industriali
- Industrial packaging
- Industrieverpackungen

■ **min**

- Prezzi speciali per l'acquisto delle quantità minime indicate (CF) dell'articolo. NB: eventuali riordini o aggiunte per completamenti se di quantità inferiore alla minima, saranno fatturati al prezzo normale
- Special prices for the purchase of the minimum quantities indicated (CF) of the article. Note Well: any reorders or additions for completions of quantity less than the minimum will be invoiced at the normal price.
- Artikel mit Sonderpreisen bei Mindestabnahmemengen sind mit (CF) gekennzeichnet. Nachbestellungen oder Ergänzungen unter der Mindestabnahmemenge werden mit dem Normalpreis verrechnet.

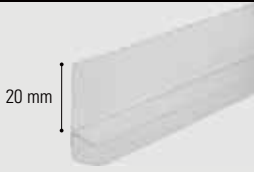
POS.	PROD.	ART.	MIS.		Q.TÀ	FIN.	EURO
B. 376		B-141-8-MIX	2500 mm	6 - 8 mm	min 5 pcs mix		48,30 /pc
		B-141-8-MIX	2500 mm	6 - 8 mm	■ min 10 pcs		41,70 /pc
B. 377		B-141-10-MIX	2500 mm	8 - 10 mm	min 5 pcs mix		52,30 /pc
		B-141-10-MIX	2500 mm	8 - 10 mm	■ min 10 pcs		47,00 /pc
B. 378		B-143-8-MIX	2500 mm	6 - 8 mm	min 5 pcs mix		48,30 /pc
		B-143-8-MIX	2500 mm	6 - 8 mm	■ min 10 pcs		41,70 /pc
B. 379		B-143-10-MIX	2500 mm	8 - 10 mm	min 5 pcs mix		52,30 /pc
		B-143-10-MIX	2500 mm	8 - 10 mm	■ min 10 pcs		47,00 /pc
B. 380		B-145-8-MIX	2500 mm	6 - 8 mm	min 5 pcs mix		18,70 /pc
		B-145-8-MIX	2500 mm	6 - 8 mm	■ 10 pcs		14,70 /pc
B. 381		B-145-10-MIX	2500 mm	10 mm	min 5 pcs mix		19,30 /pc
		B-145-10-MIX	2500 mm	10 mm	■ min 10 pcs		15,70 /pc
B. 382		B-149-8-MIX	2500 mm	6 - 8 mm	min 5 pcs mix		18,70 /pc
		B-149-8-MIX	2500 mm	6 - 8 mm	■ 10 pcs		14,70 /pc
B. 383		B-149-10-MIX	2500 mm	8 - 10 mm	min 5 pcs mix		19,30 /pc
		B-149-10-MIX	2500 mm	8 - 10 mm	■ min 10 pcs		15,70 /pc
B. 384		B-151-20-MIX	2500 mm	8 mm	min 5 pcs mix		20,50 /pc
		B-151-20-MIX	2500 mm	8 mm	■ min 10 pcs		17,00 /pc

MIX

- Minimo ordine: 5 pezzi, anche assortiti fra le varie guarnizioni e profili in alluminio
- Minimum order: 5 pieces, also for combinations of various gaskets and aluminium profiles
- Mindestbestellmenge: 5 Stück, auch sortiert nach verschiedenen Dichtungen und Aluminium Profilen

POS.	PROD.	ART.	MIS.		Q.TÀ	FIN.	EURO
B. 385		B-151-26-MIX	2200 mm	8 - 10 mm	min 5 pcs mix		24,00 /pc
		B-151-26-MIX	2200 mm	8 - 10 mm	■ min 10 pcs		20,50 /pc
B. 386		B-147-8-MIX	2200 mm	6 - 8 mm	min 5 pcs mix		20,30 /pc
		B-147-8-MIX	2200 mm	6 - 8 mm	■ min 10 pcs		16,30 /pc
B. 387		B-147-10-MIX	2200 mm	10 - 12 mm	min 5 pcs mix		20,30 /pc
		B-147-10-MIX	2200 mm	10 - 12 mm	■ min 10 pcs		16,30 /pc
B. 388		B-152-MIX	2200 mm	8 - 10 mm	min 5 pcs mix		22,30 /pc
		B-152-MIX	2200 mm	8 - 10 mm	■ min 10 pcs		19,30 /pc
B. 389		B-153-MIX	2200 mm	6 - 8 mm	min 5 pcs mix		18,70 /pc
		B-153-MIX	2200 mm	6 - 8 mm	■ min 10 pcs		15,30 /pc
B. 390		B-154-MIX	2200 mm	6 - 8 mm	min 5 pcs mix		21,70 /kit
		B-154-MIX	2200 mm	6 - 8 mm	■ min 10 pcs		17,30 /pc
B. 391		B-155-MIX	2200 mm	6 - 8 mm	min 5 pcs mix		21,70 /pc
		B-155-MIX	2200 mm	6 - 8 mm	■ min 10 pcs		17,30 /pc
B. 392		WRU-M 80/50 MT5	5 mt	8 mm	1 pc		77,50 /pc 15,50 /mt
B. 393		WRU-C-BUMP-MT12	12 mt	8 mm	1 pc		247,30 /pc 20,61 /mt

- Confezioni industriali
- Industrial packaging
- Industrieverpackungen

■ **min**

- Prezzi speciali per l'acquisto delle quantità minime indicate (CF) dell'articolo. NB: eventuali riordini o aggiunte per completamenti se di quantità inferiore alla minima, saranno fatturati al prezzo normale
- Special prices for the purchase of the minimum quantities indicated (CF) of the article. Note Well: any reorders or additions for completions of quantity less than the minimum will be invoiced at the normal price.
- Artikel mit Sonderpreisen bei Mindestabnahmemengen sind mit (CF) gekennzeichnet. Nachbestellungen oder Ergänzungen unter der Mindestabnahmemenge werden mit dem Normalpreis verrechnet.

SCORREVOLI A PARCHEGGIO

Con baia di parcheggio e senza guida a terra
Sliding stacking system with parking bay
and without bottom guide channel

Ganzglas-Schiebewandsysteme mit Parkraum
und ohne Bodenführung

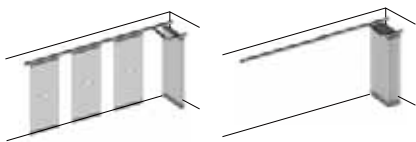

**PA-200
PARK LINE 1**

▶202

**PA-300
PARK LINE 2**

▶204

PA-230 IBRIDO

▶208

PA-400
do-it-yourself

▶212

PA-500
do-it-yourself

▶214

PA-600

▶216

PA-630

▶218

PA-200-ISO

▶222

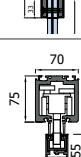
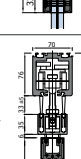
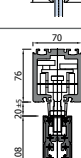
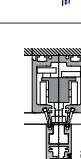
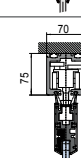
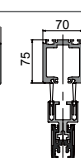
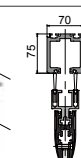
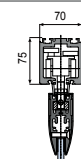

SCORREVOLI A LIBRO

Con guida a terra

Sliding folding system
with bottom guide channel

Falt-Schiebewandsysteme
mit Bodenführung

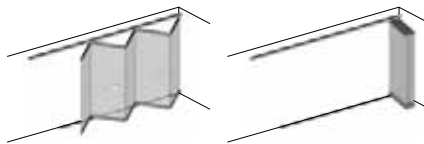

**PA-250
LIBRO FOLDING**

▶226

**PA-450
LIBRO FOLDING**
do-it-yourself

▶228

**PA-550
LIBRO FOLDING**
do-it-yourself

▶230

**PA-650
LIBRO FOLDING**

▶232

**L-1500
LIBRO FOLDING**

▶234

**L-1000
LIBRO FOLDING**

▶236

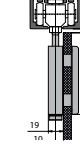
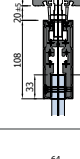
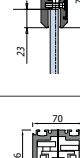
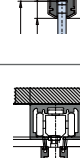
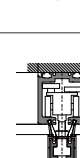
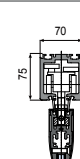

SCORREVOLI A SOFFIETTO

Senza guida a terra

Central folding sliding system
without floor rail

Falt-Schiebewandsysteme
ohne Bodenführung

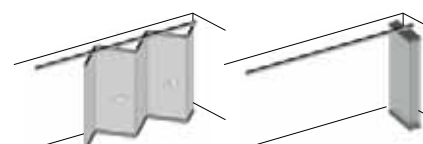

**PA-260
CENTRAL FOLDING**

▶238

**PA-460
CENTRAL FOLDING**
do-it-yourself

▶240

**PA-560
CENTRAL FOLDING**
do-it-yourself

▶242

**L-2500
CENTRAL FOLDING**

▶244

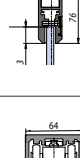
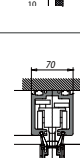
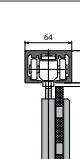

SISTEMI BALCONGLAS

Pareti mobili, senza baia di parcheggio
Balconglas sliding stacking systems
without parking bay
Schiebewandssystem Balconglas
ohne Parkraum

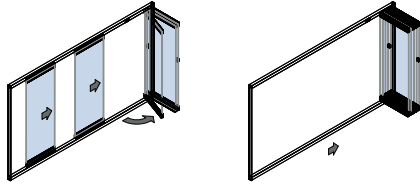

**BALCONGLAS
FALCINO**



FALCINO-50

SISTEMA CON CANALINA
SYSTEMS WITH BOTTOM GUIDE
SYSTEM MIT BODENFÜHRUNG

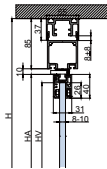

►246

FALCINO PARK-50

SISTEMA SENZA CANALINA
SYSTEMS WITHOUT
BOTTOM GUIDE
SYSTEM OHNE BODENFÜHRUNG

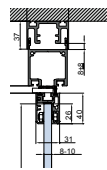

►247

**BALCONGLAS
FALCE**



FALCE-70

SISTEMA CON CANALINA
SYSTEMS WITH BOTTOM GUIDE
SYSTEM MIT BODENFÜHRUNG

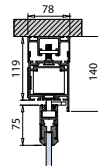

►250

FALCE PARK-70

SISTEMA SENZA CANALINA
SYSTEMS WITHOUT
BOTTOM GUIDE
SYSTEM OHNE BODENFÜHRUNG

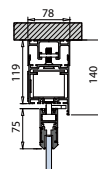

►251

FALCE-70B

SISTEMA CON CANALINA
SYSTEMS WITH
BOTTOM GUIDE
SYSTEM MIT BODENFÜHRUNG

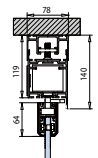

►252

FALCE PARK-70B

SISTEMA SENZA CANALINA
SYSTEMS WITHOUT
BOTTOM GUIDE
SYSTEM OHNE BODENFÜHRUNG

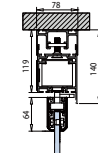

►253

FALCE-ISO

SISTEMA CON CANALINA
SYSTEMS WITH BOTTOM GUIDE
SYSTEM MIT BODENFÜHRUNG

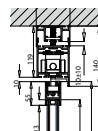

►254

FALCE PARK-ISO

SISTEMA SENZA CANALINA
SYSTEMS WITHOUT
BOTTOM GUIDE
SYSTEM OHNE BODENFÜHRUNG

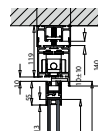

►255

LOGGIAGLAS

Sistema scorrevole telescopico studiato per balconi, logge
e verande, ideale per proteggersi da vento e intemperie
Telescopic sliding system for balcony, Loggia and
terrace, ideal for wind and weather protection
Teleskop Schiebetürsystem für Balkon und
Loggiaverglasungen, ideal für Wind-und Wetterschutz

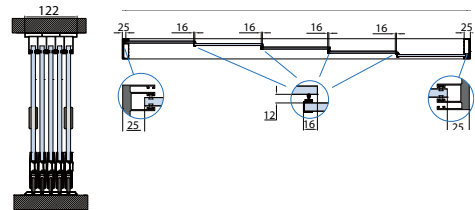

**LG-500 | LG-500-12 | LG-550
LOGGIAGLAS**

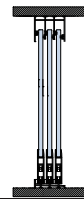

►256

**LG-510 | LG-510-12 | LG-560
LOGGIAGLAS**



►258

LG-200 LOGGIAGLAS

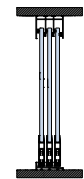

►264

LG-210 LOGGIAGLAS



►266

LG-100 LOGGIAGLAS

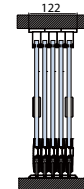

►270

PA-200

Scorrevoli a parcheggio | Sliding stacking systems | Ganzglas-Schiebewandsysteme

► PARETI MOBILI 20/24

C.01

- Set compresi di binario, profili anta e pozzetti a terra
- Set with panel profiles, rail and floor sockets
- Set mit Flügelprofile, Laufschiene und Bodenbuchse

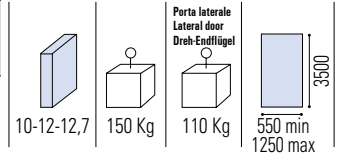

PA-200 SET 3	3 panels	AN	€ 3806,30
PA-108 / PA-109		AN	€ 1221,30
		Tot.	€ 5027,60

PA-200 SET 4	4 panels	AN	€ 4793,50
PA-108 / PA-109		AN	€ 1221,30
		Tot.	€ 6014,80

PA-200 SET 5	5 panels	AN	€ 5913,50
PA-108 / PA-109		AN	€ 1221,30
		Tot.	€ 7134,80

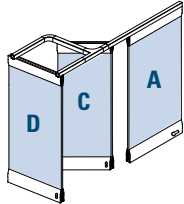

LP max = 3750 mm

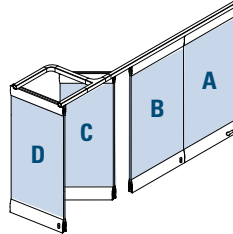

LP max = 5000 mm

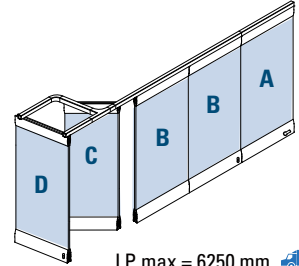

LP max = 6250 mm

PA-200 SET 6	6 panels	AN	€ 6974,00
PA-108 / PA-109		AN	€ 1221,30
		Tot.	€ 8195,30

PA-200 SET 7	7 panels	AN	€ 8034,30
PA-108 / PA-109		AN	€ 1221,30
		Tot.	€ [NSL]

PA-200 SET 8	8 panels	AN	€ 9381,00
PA-108 / PA-109		AN	€ 1221,30
		Tot.	€ 10602,30

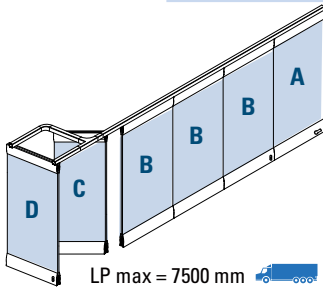

LP max = 7500 mm

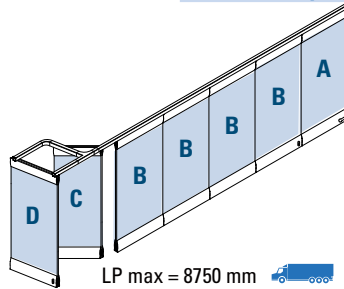

LP max = 8750 mm

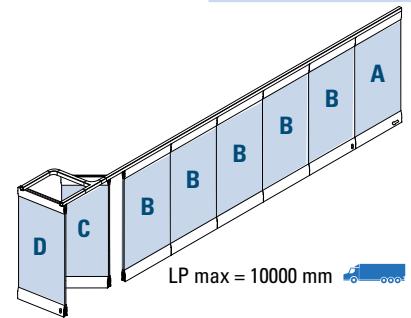

LP max = 10000 mm

PA-200 SET 9	9 panels	AN	€ 10300,70
PA-108 / PA-109		AN	€ 1221,30
		Tot.	€ 11522,00

PA-200 SET 10	10 panels	AN	€ 10848,70
PA-108 / PA-109		AN	€ 1221,30
		Tot.	€ 12070,00

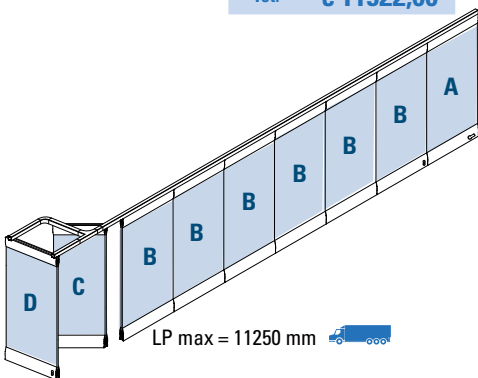

LP max = 11250 mm

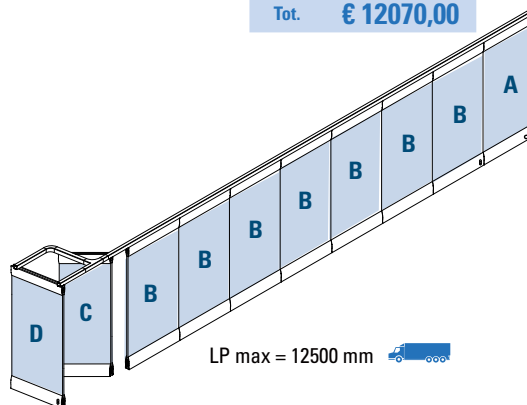

LP max = 12500 mm

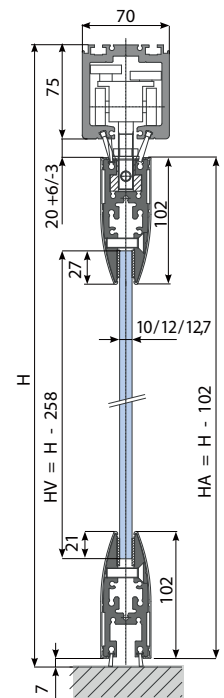
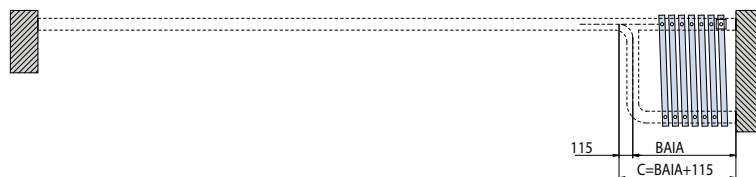

- Indicare sempre il verso di apertura, lo spessore del vetro e mandare il disegno fatto con **MY METALGLAS** al momento dell'ordine
- Please specify always opening direction, glass thickness and send technical drawing from **MY METALGLAS** when ordering
- Bitte immer Öffnungsrichtung, Glasdicke und technische Zeichnung von **MY METALGLAS** bei der Bestellung angeben

MIS

- Tagliato a misura del cliente
- Custom length
- Nach Mass geschnitten













> SET 10

- Prezzo su richiesta
- Price on request
- Preis auf Anfrage

- Progettazione configurazioni speciali da € 200 a € 600 netto
- Special design from € 200 till € 600 net
- Spezielle planung ab € 200 bis € 600 Netto

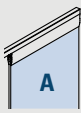
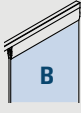
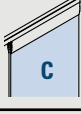
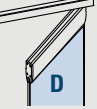

- Specificare se per apertura a destra o a sinistra
- Please specify always opening direction
- Bitte immer Öffnungsrichtung angeben

POS.	PROD.	ART.	MIS.	Q.TÀ	FIN.	EURO
PA-200 OPTIONALS		▲ PARETI MOBILI 20/24				
PA-100, PA-113, L-112 e L-112-PA inclusi nel set PA-100, PA-113, L-112 and L-112-PA in set included PA-100 , PA-113, L-112 und L-112-PA im Set enthalten						
C.02		PA-100 FIX-3000	3000 mm	1 pc	AN	431,00/pc 143,67 /m
		PA-100 FIX-6000	 6000 mm	1 pc	AN	861,50/pc 143,58 /m
C.03		TAGLIO-PM • Costo per extra taglio misura binari • Extra cost track profiles cut to size • Aufpreis Laufschiene nach Mass geschnitten		1 pc		52,00/pc
C.04		PA-108-DX PA-108-SX • Altre baie disponibili Other parking bays ▶224		1 pc	AN	1221,30/pc
C.05		PA-109-DX PA-109-SX • Altre baie disponibili Other parking bays ▶224		1 pc	AN	1221,30/pc
C.06		L-112-PA • For panel D		1 pc	CS	34,70/pc
C.07		L-112 • For panel A - B - C		1 pc	CS	34,70/pc
C.08		PA-113		1 pc	AN	51,00/pc
C.09		WRU-M 80/50 MT5		 5 mt		77,50/pc 15,50 /m
C.09.1		WRU-C-BUMP-MT12		 12 mt		247,30/pc 20,61 /m
C.10						
C.11						
C.12		PA-200 ANTA A		1 pc		1051,70/pc
C.13		PA-200 ANTA B		1 pc		900,30/pc
C.14		PA-200 ANTA C		1 pc		918,70/pc
C.15		PA-200 ANTA D		1 pc		854,50/pc

PA-300-1P (1 porta | 1 door | 1 Tür)
Scorrevoli a parcheggio | Sliding stacking systems | Ganzglas-Schiebewandsysteme

► PARETI MOBILI 26/33

C.17

- Set compresi di binario, profili anta e pozzetti a terra
- Set with panel profiles, rail and floor sockets
- Set mit Flügelprofile, Laufschiene und Bodenbuchse

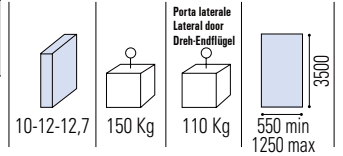

PA-300-SET4-1P	4 panels	AN	€ 6864,00
PA-108 / PA-109		AN	€ 1221,30
		Tot.	€ 8085,30

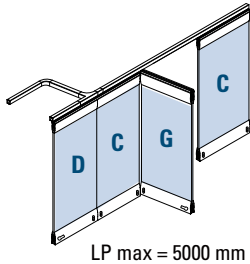

PA-300-SET5-1P	5 panels	AN	€ 8131,70
PA-108 / PA-109		AN	€ 1221,30
		Tot.	€ 9353,00

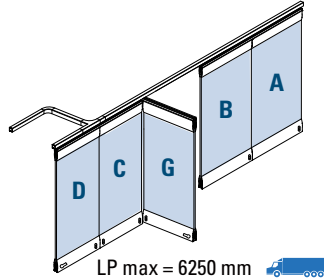

PA-300-SET6-1P	6 panels	AN	€ 9544,30
PA-108 / PA-109		AN	€ 1221,30
		Tot.	€ 10765,60

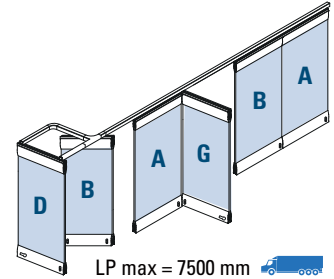

PA-300-SET7-1P	7 panels	AN	€ 10668,70
PA-108 / PA-109		AN	€ 1221,30
		Tot.	€ 11890,00

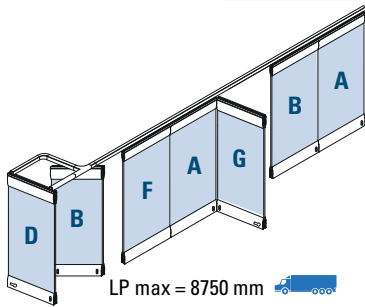

PA-300-SET8-1P	8 panels	AN	€ 12222,30
PA-108 / PA-109		AN	€ 1221,30
		Tot.	€ 13443,60

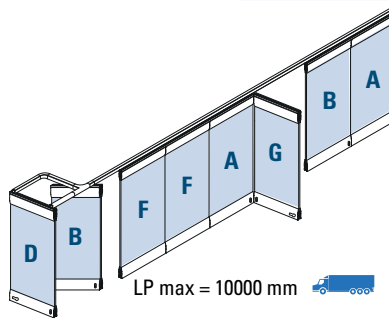

PA-300-SET9-1P	9 panels	AN	€ 13350,00
PA-108 / PA-109		AN	€ 1221,30
		Tot.	€ 14571,30

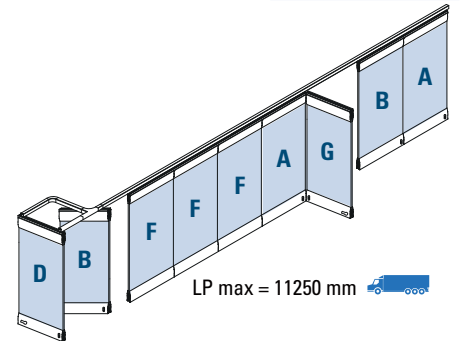

PA-300-SET10-1P	10 panels	AN	€ 14616,70
PA-108 / PA-109		AN	€ 1221,30
		Tot.	€ 15838,00

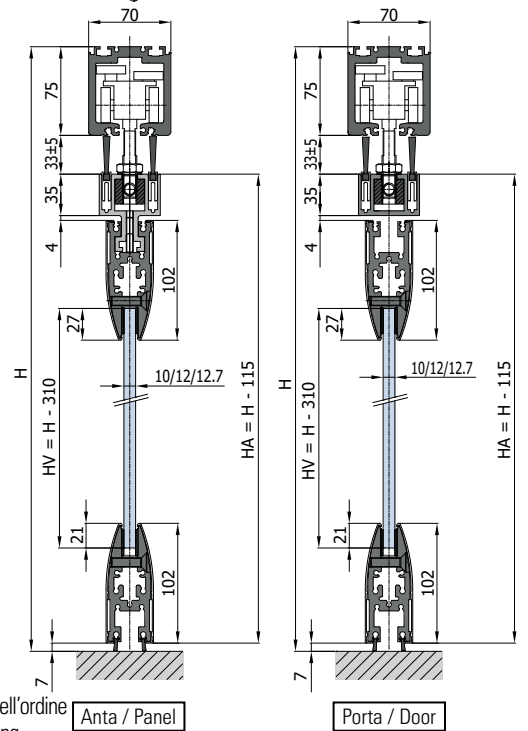
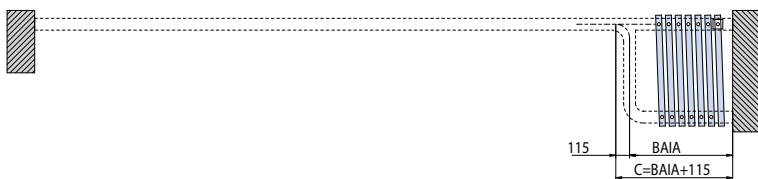
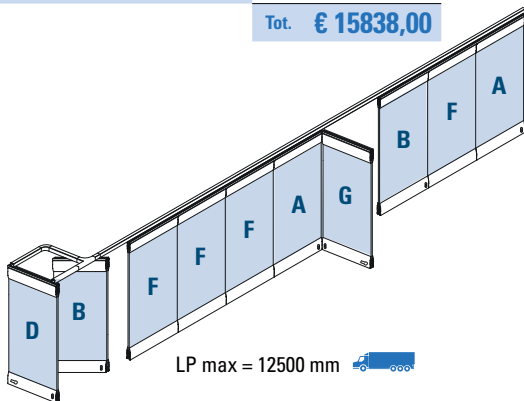

- Indicare sempre il verso di apertura, lo spessore del vetro e mandare il disegno fatto con **MY METALGLAS** al momento dell'ordine
- Please specify always opening direction, glass thickness and send technical drawing from **MY METALGLAS** when ordering
- Bitte immer Öffnungsrichtung, Glasdicke und technische Zeichnung von **MY METALGLAS** bei der Bestellung angeben

MIS

- Tagliato a misura del cliente
- Custom length
- Nach Mass geschnitten

> SET 10

- Prezzo su richiesta
- Price on request
- Preis auf Anfrage

- Progettazione configurazioni speciali da € 200 a € 600 netto
- Special design from € 200 till € 600 net
- Spezielle planung ab € 200 bis € 600 Netto



- Specificare se per apertura a destra o a sinistra
- Please specify always opening direction
- Bitte immer Öffnungsrichtung angeben

PA-300-2P (2 porte | 2 doors | 2 Türen)

Scorrevoli a parcheggio | Sliding stacking systems | Ganzglas-Schiebewandsysteme

► PARETI MOBILI 26/33
C.18

- Set compresi di binario, profili anta e pozzetti a terra
- Set with panel profiles, rail and floor sockets
- Set mit Flügelprofile, Laufschiene und Bodenbuchse

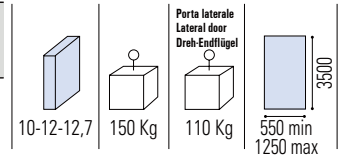

PA-300-SET4-2P	4 panels	AN	€ 7721,50
PA-108 / PA-109		AN	€ 1221,30
		Tot.	€ 8942,80

PA-300-SET5-2P	5 panels	AN	€ 9146,30
PA-108 / PA-109		AN	€ 1221,30
		Tot.	€ 10367,60

PA-300-SET6-2P	6 panels	AN	€ 10556,30
PA-108 / PA-109		AN	€ 1221,30
		Tot.	€ 11777,60

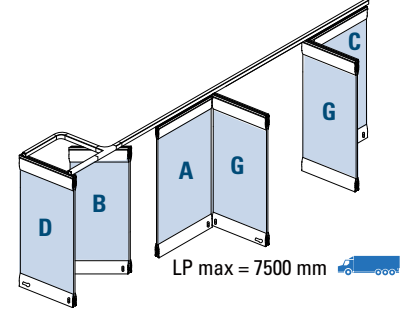
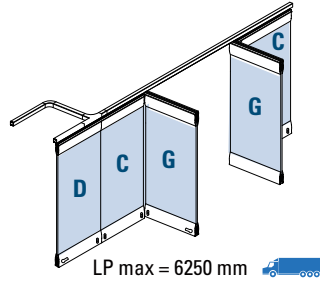
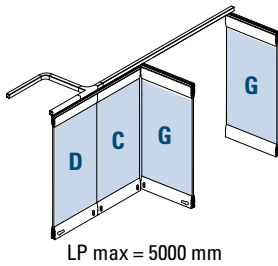

PA-300-SET7-2P	7 panels	AN	€ 11682,00
PA-108 / PA-109		AN	€ 1221,30
		Tot.	€ 12903,30

PA-300-SET8-2P	8 panels	AN	€ 13235,50
PA-108 / PA-109		AN	€ 1221,30
		Tot.	€ 14456,80

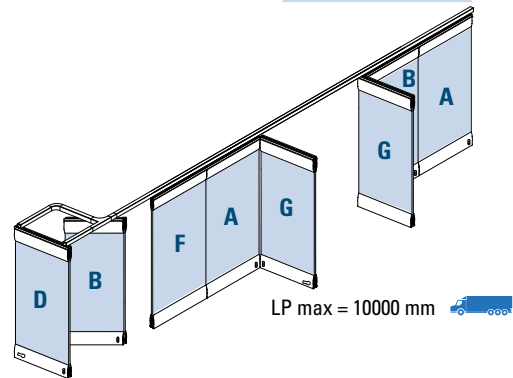
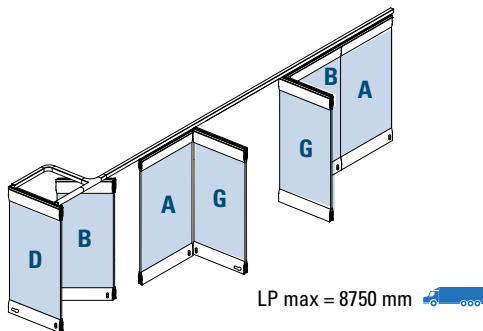

PA-300-SET9-2P	9 panels	AN	€ 14364,50
PA-108 / PA-109		AN	€ 1221,30
		Tot.	€ 15585,80

PA-300-SET10-2P	10 panels	AN	€ 15631,50
PA-108 / PA-109		AN	€ 1221,30
		Tot.	€ 16852,80

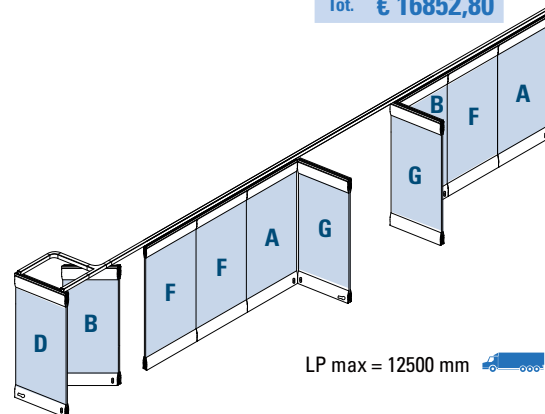
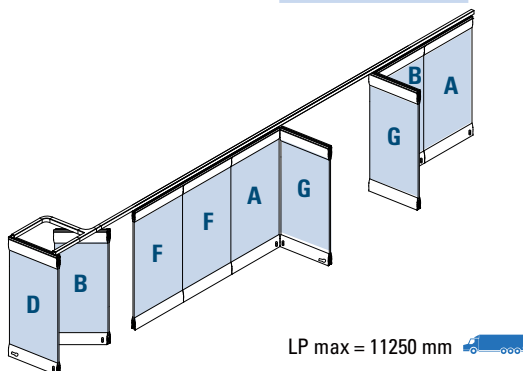

- Possibilità di chiudiporta idraulico per anta G. Prezzo su richiesta
- Optional hydraulic door closer for panel G. Price on request
- Optional hydrauliker Türschließer für Flügel G. Preis auf Anfrage

- Indicare sempre il verso di apertura, lo spessore del vetro e mandare il disegno fatto con **MY METALGLAS** al momento dell'ordine
- Please specify always opening direction, glass thickness and send technical drawing from **MY METALGLAS** when ordering
- Bitte immer Öffnungsrichtung, Glasdicke und technische Zeichnung von **MY METALGLAS** bei der Bestellung angeben

- Trasporto fuori standard. Vedi condizioni di vendita
- Non-standard transport. See sales conditions
- Sondertransport. Siehe AGB

POS.	PROD.	ART.	MIS.	Q.TÀ	FIN.	EURO
PA-300 OPTIONALS		▲ PARETI MOBILI 26/33				
PA-100, PA-113, L-112 e L-112-PA inclusi nel set PA-100, PA-113, L-112 and L-112-PA in set included PA-100, PA-113, L-112 und L-112-PA im Set enthalten						
C.19		PA-100 FIX-3000	3000 mm	1 pc	AN	431,00/pc 143,67 /m
		PA-100 FIX-6000	6000 mm	1 pc	AN	861,50/pc 143,58 /m
C.20		TAGLIO-PM • Costo per extra taglio misura binari • Extra cost track profiles cut to size • Aufpreis Laufschiene nach Mass geschnitten		1 pc		52,00/pc
C.21		PA-108-DX PA-108-SX • Altre baie disponibili Other parking bays ▶224		1 pc	AN	1221,30/pc
C.22		PA-109-DX PA-109-SX • Altre baie disponibili Other parking bays ▶224		1 pc	AN	1221,30/pc
C.23		L-112-PA • For panel D and G		1 pc	CS	34,70/pc
C.24		L-112 • For panel A - B - C - F		1 pc	CS	34,70/pc
C.25		PA-215		1 pc	IX	63,70/pc
C.26		PA-113		1 pc	AN	51,00/pc
C.27		PA-300 CHIAVE		1 pc		180,70/pc
C.28		WRU-M 80/50 MT5		5 mt		77,50/pc 15,50 /m
C.28.1		WRU-C-BUMP-MT12		12 mt		247,30/pc 20,61 /m
C.29						
C.30						

MIS





- Tagliato a misura del cliente
- Custom length
- Nach Mass geschnitten



- Specificare se per apertura a destra o a sinistra
- Please specify always opening direction
- Bitte immer Öffnungsrichtung angeben

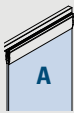
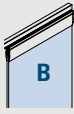
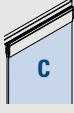

- Trasporto fuori standard. Vedi condizioni di vendita
- Non-standard transport. See sales conditions
- Sondertransport. Siehe AGB

POS.	PROD.	ART.	MIS.	Q.TÀ	FIN.	EURO
C.31		PA-300 ANTA A		1 pc		1267,30/pc
C.32		PA-300 ANTA B		1 pc		1106,50/pc
C.33		PA-300 ANTA C		1 pc		1265,00/pc
C.34		PA-300 ANTA D		1 pc		1066,50/pc
C.35		PA-300 ANTA F		1 pc		1106,50/pc
C.36		PA-300 ANTA G		1 pc		2121,30/pc

- Possibilità di chiudiporta idraulico per anta G. Prezzo su richiesta
- Optional hydraulic door closer for panel G. Price on request
- Optional hydrauliker Türschließer für Flügel G. Preis auf Anfrage

PA-230-1P "IBRIDO" (1 porta | 1 door | 1 Tür)
Scorrevoli a parcheggio | Sliding stacking systems | Ganzglas-Schiebewandsysteme

► PARETI MOBILI 34/35

C.37

- Set compresi di binario, profili anta e pozzetti a terra
- Set with panel profiles, rail and floor sockets
- Set mit Flügelprofile, Laufschiene und Bodenbuchse

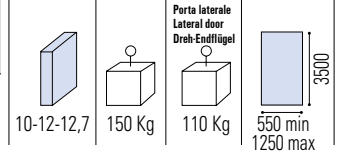

PA-230-SET4-1P	4 panels	AN	€ 6061,30
PA-108 / PA-109		AN	€ 1221,30
		Tot.	€ 7282,60

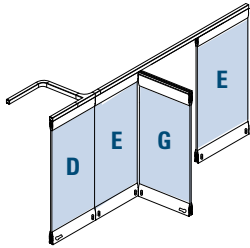

LP max = 5000 mm

PA-230-SET5-1P	5 panels	AN	€ 7205,50
PA-108 / PA-109		AN	€ 1221,30
		Tot.	€ 8426,80

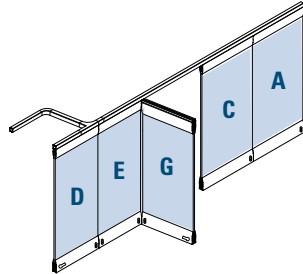

LP max = 6250 mm

PA-230-SET6-1P	6 panels	AN	€ 8487,30
PA-108 / PA-109		AN	€ 1221,30
		Tot.	€ 9708,60

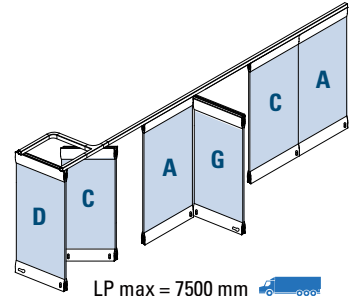

LP max = 7500 mm

PA-230-SET7-1P	7 panels	AN	€ 9404,50
PA-108 / PA-109		AN	€ 1221,30
		Tot.	€ 10625,80

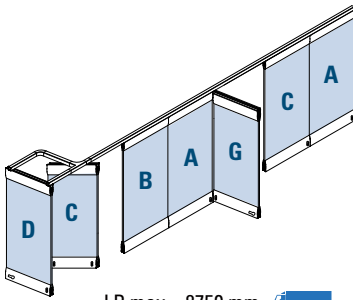

LP max = 8750 mm

PA-230-SET8-1P	8 panels	AN	€ 10751,30
PA-108 / PA-109		AN	€ 1221,30
		Tot.	€ 11972,60

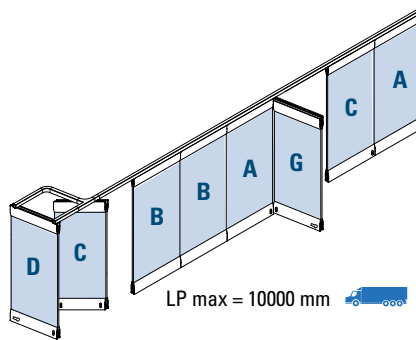

LP max = 10000 mm

PA-230-SET9-1P	9 panels	AN	€ 11669,70
PA-108 / PA-109		AN	€ 1221,30
		Tot.	€ 12891,00

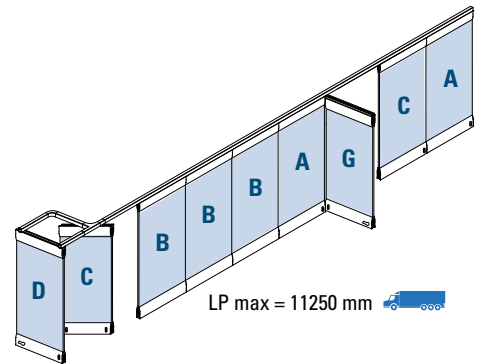

LP max = 11250 mm

PA-230-SET10-1P	10 panels	AN	€ 12731,00
PA-108 / PA-109		AN	€ 1221,30
		Tot.	€ 13952,30

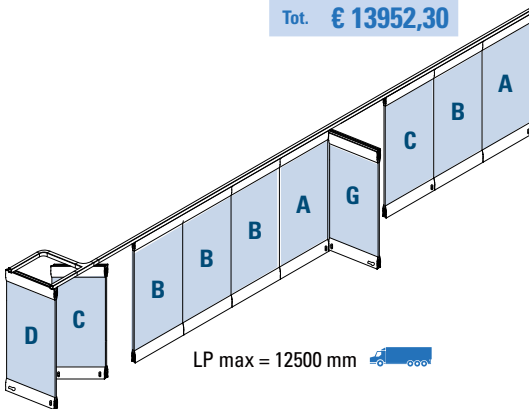

LP max = 12500 mm

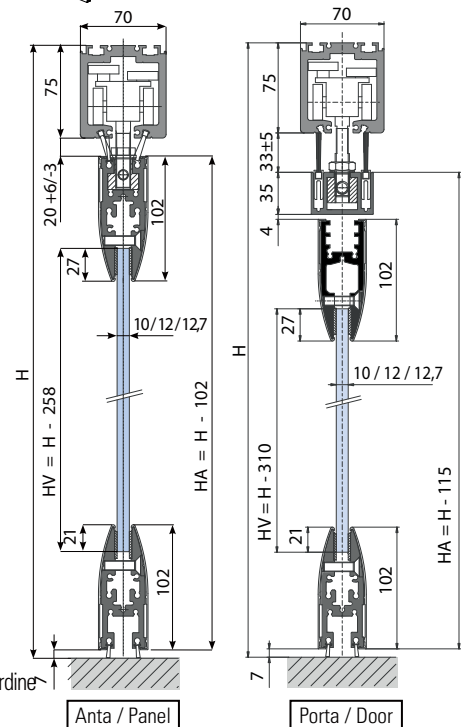
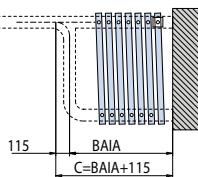

- Indicare sempre il verso di apertura, lo spessore del vetro e mandare il disegno fatto con **MY METALGLAS** al momento dell'ordine
- Please specify always opening direction, glass thickness and send technical drawing from **MY METALGLAS** when ordering
- Bitte immer Öffnungsrichtung, Glasdicke und technische Zeichnung von **MY METALGLAS** bei der Bestellung angeben

MIS

- Tagliato a misura del cliente
- Custom length
- Nach Mass geschnitten

> SET 10

- Prezzo su richiesta
- Price on request
- Preis auf Anfrage

- Progettazione configurazioni speciali da € 200 a € 600 netto
- Special design from € 200 till € 600 net
- Spezielle planung ab € 200 bis € 600 Netto



- Specificare se per apertura a destra o a sinistra
- Please specify always opening direction
- Bitte immer Öffnungsrichtung angeben

PA-230-2P "IBRIDO" (2 porte | 2 doors | 2 Türen)

Scorrevoli a parcheggio | Sliding stacking systems | Ganzglas-Schiebewandsysteme

► PARETI MOBILI 34/35

C.38

- Set compresi di binario, profili anta e pozzetti a terra
- Set with panel profiles, rail and floor sockets
- Set mit Flügelprofile, Laufschiene und Bodenbuchse

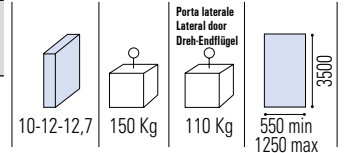

PA-230-SET4-2P	4 panels	AN	€ 7217,00
PA-108 / PA-109		AN	€ 1221,30
		Tot.	€ 8438,30

PA-230-SET5-2P	5 panels	AN	€ 8346,00
PA-108 / PA-109		AN	€ 1221,30
		Tot.	€ 9567,30

PA-230-SET6-2P	6 panels	AN	€ 9626,50
PA-108 / PA-109		AN	€ 1221,30
		Tot.	€ 10847,80

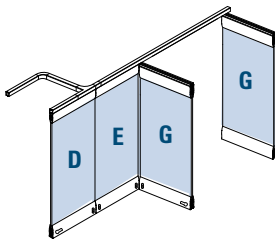

LP max = 5000 mm

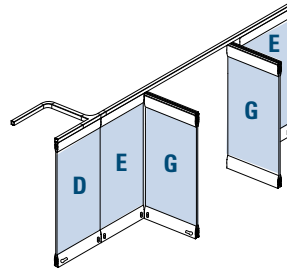

LP max = 6250 mm

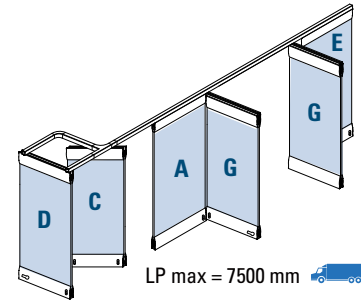

LP max = 7500 mm

PA-230-SET7-2P	7 panels	AN	€ 10625,30
PA-108 / PA-109		AN	€ 1221,30
		Tot.	€ 11846,60

PA-230-SET8-2P	8 panels	AN	€ 11974,30
PA-108 / PA-109		AN	€ 1221,30
		Tot.	€ 13195,60

PA-230-SET9-2P	9 panels	AN	€ 12891,50
PA-108 / PA-109		AN	€ 1221,30
		Tot.	€ 14112,80

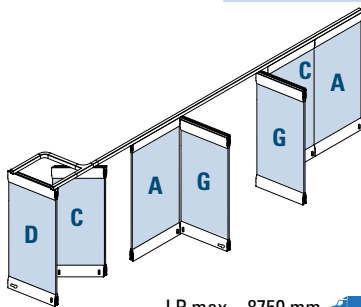

LP max = 8750 mm

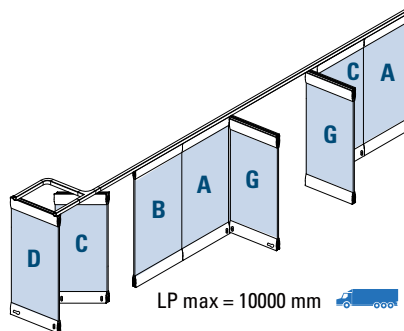

LP max = 10000 mm

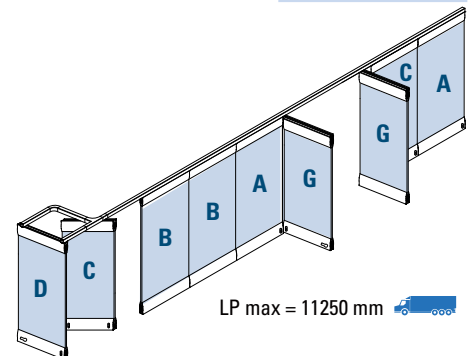

LP max = 11250 mm

PA-230-SET10-2P	10 panels	AN	€ 13952,30
PA-108 / PA-109		AN	€ 1221,30
		Tot.	€ 15173,60

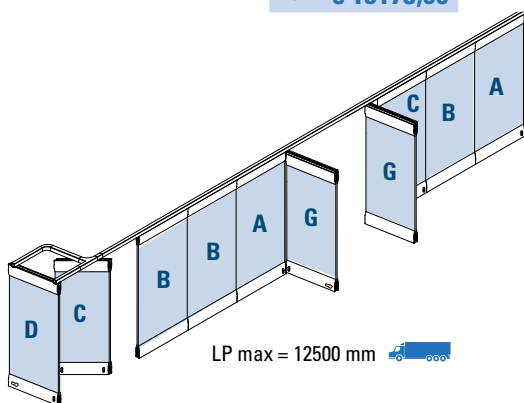

LP max = 12500 mm

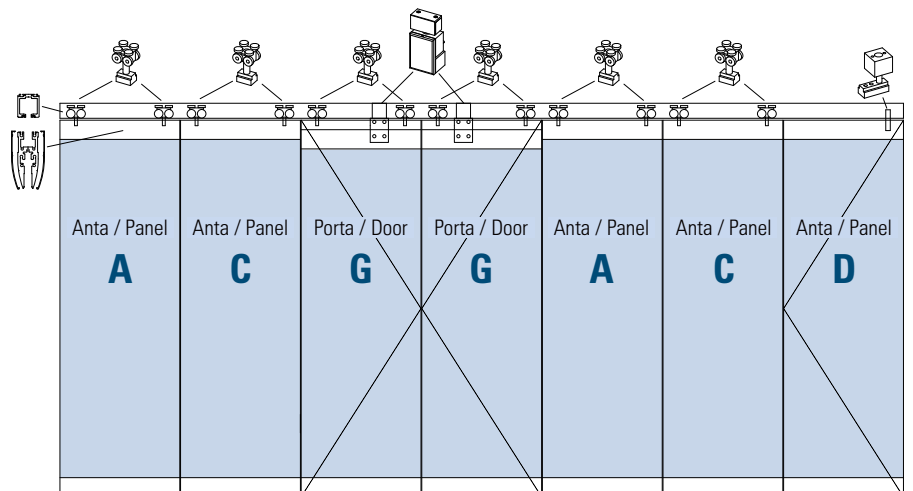

- Possibilità di chiudiporta idraulico per anta G. Prezzo su richiesta
- Optional hydraulic door closer for panel G. Price on request
- Optional hydrauliker Türschließer für Flügel G. Preis auf Anfrage

- Indicare sempre il verso di apertura, lo spessore del vetro e mandare il disegno fatto con [MY METALGLAS](#) al momento dell'ordine
- Please specify always opening direction, glass thickness and send technical drawing from [MY METALGLAS](#) when ordering
- Bitte immer Öffnungsrichtung, Glasdicke und technische Zeichnung von [MY METALGLAS](#) bei der Bestellung angeben

- Trasporto fuori standard. Vedi condizioni di vendita
- Non-standard transport. See sales conditions
- Sondertransport. Siehe AGB

POS.	PROD.	ART.	MIS.	Q.TÀ	FIN.	EURO
PA-230 "IBRIDO" OPTIONALS ▲ PARETI MOBILI 34/35						
PA-100, PA-113, L-112 e L-112-PA inclusi nel set PA-100, PA-113, L-112 and L-112-PA in set included PA-100, PA-113, L-112 und L-112-PA im Set enthalten						
C.39		PA-100 FIX-3000	3000 mm	1 pc	AN	431,00/pc 143,67 /m
		PA-100 FIX-6000	6000 mm	1 pc	AN	861,50/pc 143,58 /m
C.40		TAGLIO-PM • Costo per extra taglio misura binari • Extra cost track profiles cut to size • Aufpreis Laufschiene nach Mass geschnitten		1 pc		52,00/pc
C.41	SX DX	PA-108-DX PA-108-SX • Altre baie disponibili Other parking bays ▶224		1 pc	AN	1221,30/pc
C.42	SX DX	PA-109-DX PA-109-SX • Altre baie disponibili Other parking bays ▶224		1 pc	AN	1221,30/pc
C.43		L-112-PA • For panel D and G		1 pc	CS	34,70/pc
C.44		L-112 • For panel A - B - C - E		1 pc	CS	34,70/pc
C.45		PA-215		1 pc	IX	63,70/pc
C.46		PA-113		1 pc	AN	51,00/pc
C.47		PA-300 CHIAVE		1 pc	AN	180,70/pc
C.48		WRU-M 80/50 MT5		5 mt		77,50/pc 15,50 /m
C.48.1		WRU-C-BUMP-MT12		12 mt		247,30/pc 20,61 /m
C.49						
C.50						

MIS





- Tagliato a misura del cliente
- Custom length
- Nach Mass geschnitten



- Specificare se per apertura a destra o a sinistra
- Please specify always opening direction
- Bitte immer Öffnungsrichtung angeben

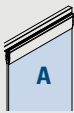
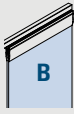
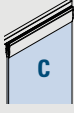

- Trasporto fuori standard. Vedi condizioni di vendita
- Non-standard transport. See sales conditions
- Sondertransport. Siehe AGB

POS.	PROD.	ART.	MIS.	Q.TÀ	FIN.	EURO
C.51		PA-200 ANTA A		1 pc		1051,70/pc
C.52		PA-200 ANTA B		1 pc		900,30/pc
C.53		PA-200 ANTA C		1 pc		918,70/pc
C.54		PA-200 ANTA D		1 pc		854,50/pc
C.55		PA-230 ANTA E		1 pc		1037,30/pc
C.56		PA-300 ANTA G		1 pc		2121,30/pc

- Possibilità di chiudiporta idraulico per anta G. Prezzo su richiesta
- Optional hydraulic door closer for panel G. Price on request
- Optional hydrauliker Türschließer für Flügel G. Preis auf Anfrage

PA-400

Scorevoli a parcheggio | Sliding stacking systems | Ganzglas-Schiebewandsysteme

► PARETI MOBILI 36/37

C.57

- Set compresi di binario, profili anta e pozzetti a terra
- Set with panel profiles, rail and floor sockets
- Set mit Flügelprofile, Laufschiene und Bodenbuchse

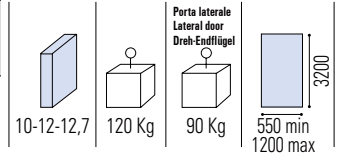

PA-400 SET 3	3 panels	AN	€ 3806,30
PA-108 / PA-109		AN	€ 1221,30
		Tot.	€ 5027,60

PA-400 SET 4	4 panels	AN	€ 4793,50
PA-108 / PA-109		AN	€ 1221,30
		Tot.	€ 6014,80

PA-400 SET 5	5 panels	AN	€ 5913,50
PA-108 / PA-109		AN	€ 1221,30
		Tot.	€ 7134,80

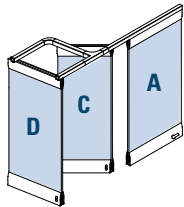

LP max = 3600 mm

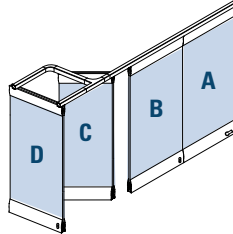

LP max = 4800 mm

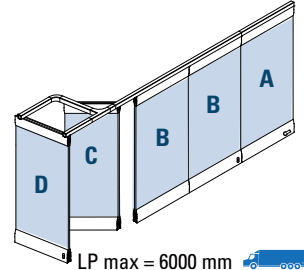

LP max = 6000 mm

PA-400 SET 6	6 panels	AN	€ 6974,00
PA-108 / PA-109		AN	€ 1221,30
		Tot.	€ 8195,30

PA-400 SET 7	7 panels	AN	€ 8034,30
PA-108 / PA-109		AN	€ 1221,30
		Tot.	€ 9255,60

PA-400 SET 8	8 panels	AN	€ 9381,00
PA-108 / PA-109		AN	€ 1221,30
		Tot.	€ 10602,30

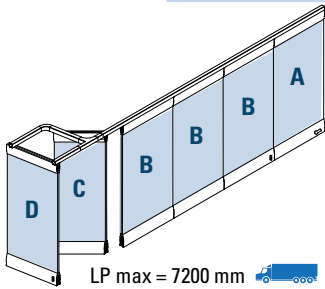

LP max = 7200 mm

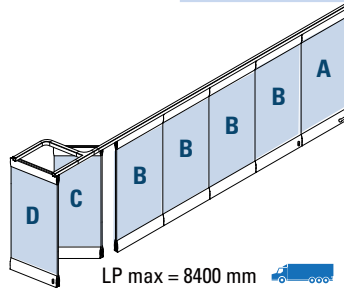

LP max = 8400 mm

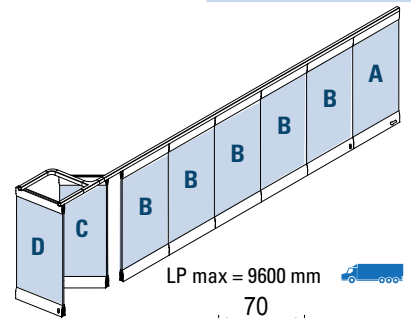

LP max = 9600 mm

PA-400 SET 9	9 panels	AN	€ 10300,70
PA-108 / PA-109		AN	€ 1221,30
		Tot.	€ 11522,00

PA-400 SET 10	10 panels	AN	€ 10848,70
PA-108 / PA-109		AN	€ 1221,30
		Tot.	€ 12070,00

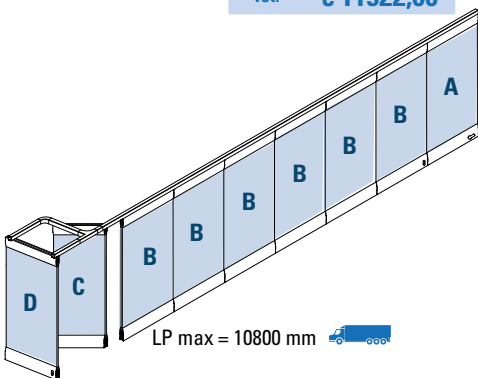

LP max = 10800 mm

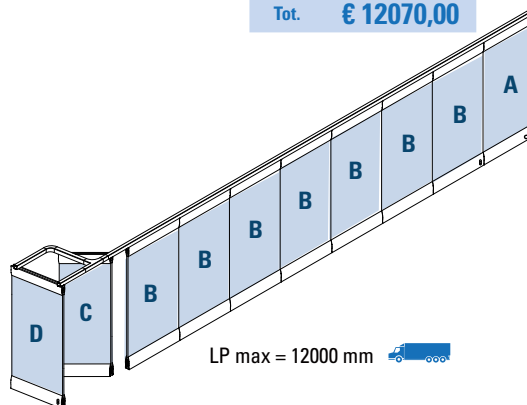

LP max = 12000 mm

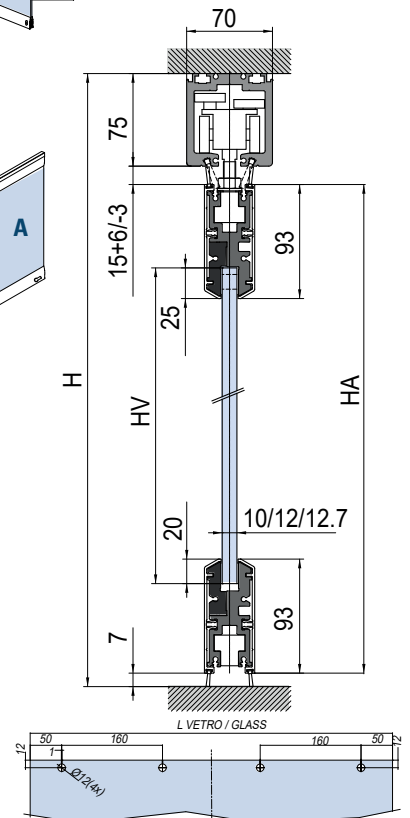
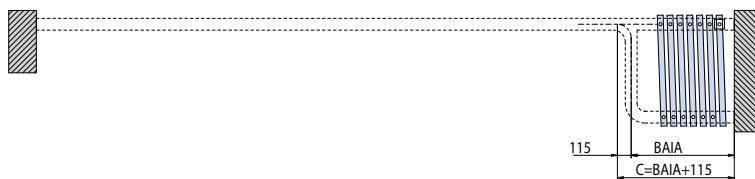

Lavorazione vetro | Glass preparation | Glasbearbeitung

- Indicare sempre il verso di apertura, lo spessore del vetro e mandare il disegno fatto con **MY METALGLAS** al momento dell'ordine
- Please specify always opening direction, glass thickness and send technical drawing from **MY METALGLAS** when ordering
- Bitte immer Öffnungsrichtung, Glasdicke und technische Zeichnung von **MY METALGLAS** bei der Bestellung angeben











MIS
 • Tagliato dal cliente
 • Cut by installer
 • Schnitt bauseitig

MIS
 • Tagliato a misura del cliente
 • Custom length
 • Nach Mass geschnitten

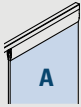
> SET 10
 • Prezzo su richiesta
 • Price on request
 • Preis auf Anfrage

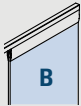
• Progettazione configurazioni speciali da € 200 a € 600 netto
 • Special design from € 200 till € 600 net
 • Spezielle planung ab € 200 bis € 600 Netto

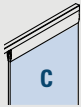
!
 • Specificare se per apertura a destra o a sinistra
 • Please specify always opening direction
 • Bitte immer Öffnungsrichtung angeben

POS.	PROD.	ART.	MIS.	Q.TÀ	FIN.	EURO
PA-400 OPTIONALS		▲ PARETI MOBILI 36/37				
PA-100, PA-113 e L-112-PA inclusi nel set PA-100, PA-113 and L-112-PA in set included PA-100, PA-113 und L-112-PA im Set enthalten						
C.58		PA-100 FIX-3000	3000 mm	1 pc	AN	431,00 /pc 143,67 /m
		PA-100 FIX-6000	 6000 mm	1 pc	AN	861,50 /pc 143,58 /m
C.59		TAGLIO-PM • Costo per extra taglio misura binari • Extra cost track profiles cut to size • Aufpreis Laufschiene nach Mass geschnitten		1 pc		52,00 /pc
C.60		PA-108-DX PA-108-SX • Altre baie disponibili Other parking bays ▶224		1 pc	AN	1221,30 /pc
C.61		PA-109-DX PA-109-SX • Altre baie disponibili Other parking bays ▶224		1 pc	AN	1221,30 /pc
C.62		L-112-PA		1 pc	CS	34,70 /pc
C.63		PA-113		1 pc	AN	51,00 /pc
C.64		WRU-M 80/50 MT5		 5 mt		77,50 /pc 15,50 /m
C.64.1		WRU-C-BUMP-MT12		 12 mt		247,30 /pc 20,61 /m
C.65						
C.66						
C.67		PA-400 ANTA A  L = 1200 mm		1 pc		1051,70 /pc
C.68		PA-400 ANTA B  L = 1200 mm		1 pc		900,30 /pc
C.69		PA-400 ANTA C  L = 1200 mm		1 pc		918,70 /pc
C.70		PA-400 ANTA D  L = 1200 mm		1 pc		915,30 /pc



- Trasporto fuori standard. Vedi condizioni di vendita
- Non-standard transport. See sales conditions
- Sondertransport. Siehe AGB

do-it-yourself

- Profili anta forniti in misura FIX da tagliare cliente secondo schema [MY METALGLAS](#)
- Panel profiles supplied in FIX length cut by installer according to [MY METALGLAS](#) configurator
- Flügelprofile in Fixlängen schnitt bauseitig gemäss Konfigurator [MY METALGLAS](#)

PA-500
Scorrevoli a parcheggio | Sliding stacking systems | Ganzglas-Schiebewandsysteme

► PARETI MOBILI 38/42

C.71

- Set compresi di binario, profili anta e pozzetti a terra
- Set with panel profiles, rail and floor sockets
- Set mit Flügelprofile, Laufschiene und Bodenbuchse

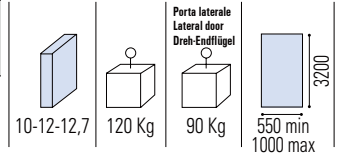

PA-500 SET 3	3 panels	AN	€ 3135,50
PA-108 / PA-109		AN	€ 1221,30
		Tot.	€ 4356,80

PA-500 SET 4	4 panels	AN	€ 4422,70
PA-108 / PA-109		AN	€ 1221,30
		Tot.	€ 5644,00

PA-500 SET 5	5 panels	AN	€ 5266,00
PA-108 / PA-109		AN	€ 1221,30
		Tot.	€ 6487,30

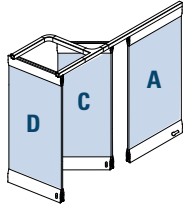

LP max = 3000 mm

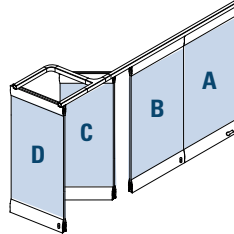

LP max = 4000 mm

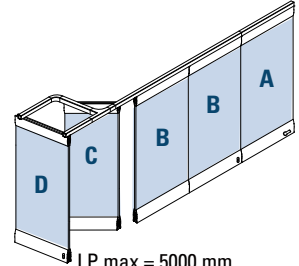

LP max = 5000 mm

PA-500 SET 6	6 panels	AN	€ 6111,00
PA-108 / PA-109		AN	€ 1221,30
		Tot.	€ 7332,30

PA-500 SET 7	7 panels	AN	€ 7393,30
PA-108 / PA-109		AN	€ 1221,30
		Tot.	€ 8614,60

PA-500 SET 8	8 panels	AN	€ 8237,70
PA-108 / PA-109		AN	€ 1221,30
		Tot.	€ 9459,00

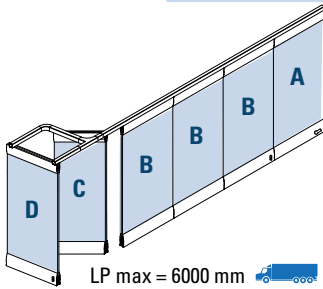

LP max = 6000 mm

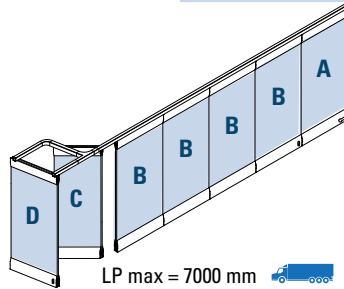

LP max = 7000 mm

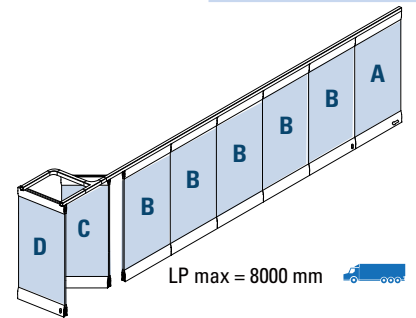

LP max = 8000 mm

PA-500 SET 9	9 panels	AN	€ 9079,70
PA-108 / PA-109		AN	€ 1221,30
		Tot.	€ 10301,00

PA-500 SET 10	10 panels	AN	€ 10368,00
PA-108 / PA-109		AN	€ 1221,30
		Tot.	€ 11589,30

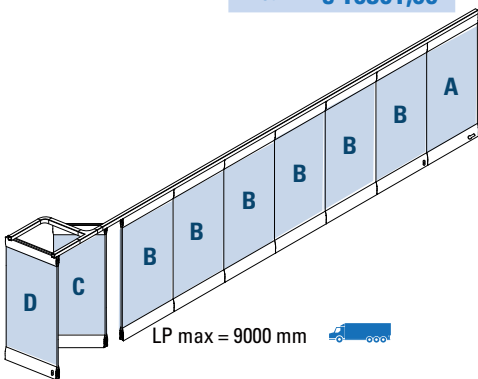

LP max = 9000 mm

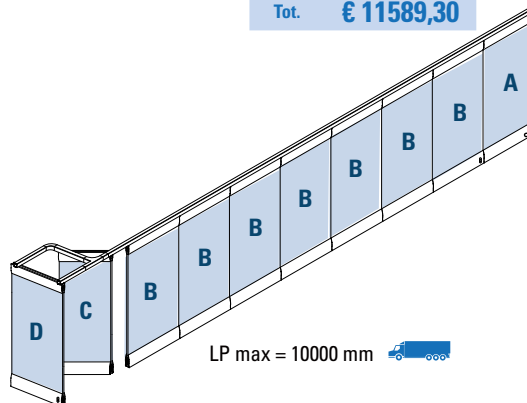

LP max = 10000 mm

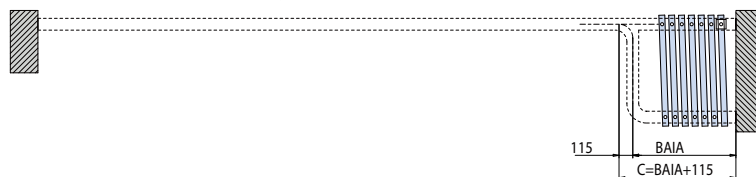
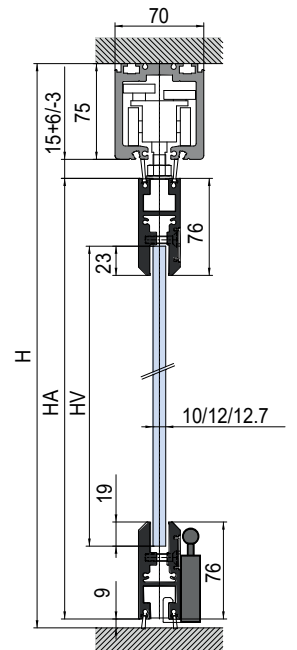

- Indicare sempre il verso di apertura, lo spessore del vetro e mandare il disegno fatto con **MY METALGLAS** al momento dell'ordine
- Please specify always opening direction, glass thickness and send technical drawing from **MY METALGLAS** when ordering
- Bitte immer Öffnungsrichtung, Glasdicke und technische Zeichnung von **MY METALGLAS** bei der Bestellung angeben

MIS
 • Tagliato dal cliente
 • Cut by installer
 • Schnitt bauseitig

MIS
 • Tagliato a misura del cliente
 • Custom length
 • Nach Mass geschnitten

> SET 10
 • Prezzo su richiesta
 • Price on request
 • Preis auf Anfrage

• Progettazione configurazioni speciali da € 200 a € 600 netto
 • Special design from € 200 till € 600 net
 • Spezielle Planung ab € 200 bis € 600 Netto

!
 • Specificare se per apertura a destra o a sinistra
 • Please specify always opening direction
 • Bitte immer Öffnungsrichtung angeben

POS.	PROD.	ART.	MIS.	Q.TÀ	FIN.	EURO
PA-500 OPTIONALS ▲ PARETI MOBILI 38/42						
PA-100, PA-113, PA-502 e BGF-10 inclusi nel set PA-100, PA-113, PA-502 and BGF-10 in set included PA-100, PA-113, PA-502 und BGF-10 im Set enthalten						
C.72		PA-100 FIX-3000	3000 mm	1 pc	AN	431,00/pc 143,67 /m
		PA-100 FIX-6000	6000 mm	1 pc	AN	861,50/pc 143,58 /m
C.73		TAGLIO-PM • Costo per extra taglio misura binari • Extra cost track profiles cut to size • Aufpreis Laufschiene nach Mass geschnitten		1 pc		52,00/pc
C.74		PA-108-DX PA-108-SX • Altre baie disponibili Other parking bays ▶224		1 pc	AN	1221,30/pc
C.75		PA-109-DX PA-109-SX • Altre baie disponibili Other parking bays ▶224		1 pc	AN	1221,30/pc
C.76		PA-113		1 pc	AN	51,00/pc
C.77		WRU-M 80/50 MT5		5 mt		77,50/pc 15,50 /m
C.77.1		WRU-C-BUMP-MT12		12 mt		247,30/pc 20,61 /m
C.78						
C.79						
C.80		PA-500 ANTA A L = 1000 mm		1 pc		897,00/pc
C.81		PA-500 ANTA B L = 1000 mm		1 pc		837,30/pc
C.82		PA-500 ANTA C L = 1000 mm		1 pc		828,00/pc
C.83		PA-500 ANTA D L = 1000 mm		1 pc		755,00/pc
C.84		PA-502		1 pc	AN	60,00/pc
C.85		BGF-10		1 pc		6,30/pc

Trasporto fuori standard. Vedi condizioni di vendita
 • Non-standard trasport. See sales conditions
 • Sondertransport. Siehe AGB

do-it-yourself
 • Profili anta forniti in misura FIX da tagliare cliente secondo schema [MY METALGLAS](#)
 • Panel profiles supplied in FIX length cut by installer according to [MY METALGLAS](#) configurator
 • Flügelprofile in Fixlängen schnitt bauseitig gemäss Konfigurator [MY METALGLAS](#)

PA-600

Scorrevoli a parcheggio | Sliding stacking systems | Ganzglas-Schiebewandsysteme

► PARETI MOBILI 44/48

C.86

- Set compresi di binario, profili anta e pozzetti a terra
- Set with panel profiles, rail and floor sockets
- Set mit Flügelprofile, Laufschiene und Bodenbuchse

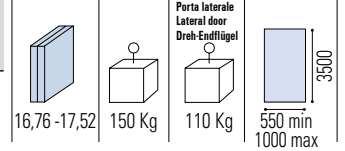

PA-600 SET 3	3 panels	AN	€ 4890,70
PA-108 / PA-109		AN	€ 1221,30
		Tot.	€ 6112,00

PA-600 SET 4	4 panels	AN	€ 6105,00
PA-108 / PA-109		AN	€ 1221,30
		Tot.	€ 7326,30

PA-600 SET 5	5 panels	AN	€ 7454,00
PA-108 / PA-109		AN	€ 1221,30
		Tot.	€ 8675,30

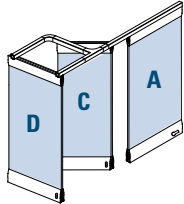

LP max = 3000 mm

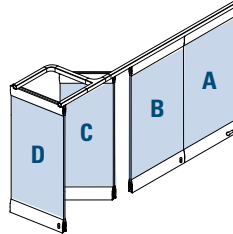

LP max = 4000 mm

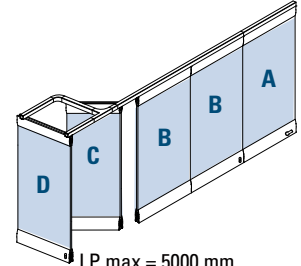

LP max = 5000 mm

PA-600 SET 6	6 panels	AN	€ 8808,30
PA-108 / PA-109		AN	€ 1221,30
		Tot.	€ 10029,60

PA-600 SET 7	7 panels	AN	€ 10163,00
PA-108 / PA-109		AN	€ 1221,30
		Tot.	€ 11384,30

PA-600 SET 8	8 panels	AN	€ 11801,30
PA-108 / PA-109		AN	€ 1221,30
		Tot.	€ 13022,60

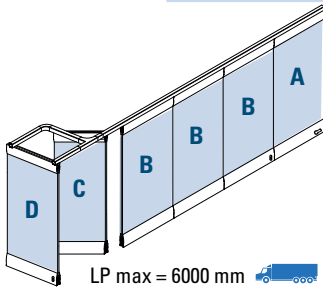

LP max = 6000 mm

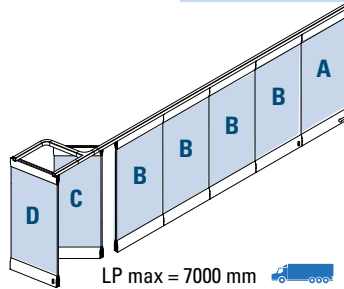

LP max = 7000 mm

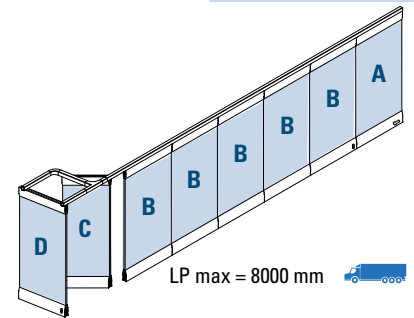

LP max = 8000 mm

PA-600 SET 9	9 panels	AN	€ 13013,00
PA-108 / PA-109		AN	€ 1221,30
		Tot.	€ 14234,30

PA-600 SET 10	10 panels	AN	€ 14365,70
PA-108 / PA-109		AN	€ 1221,30
		Tot.	€ 15587,00

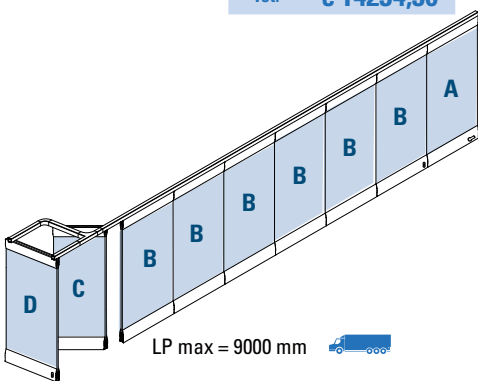

LP max = 9000 mm

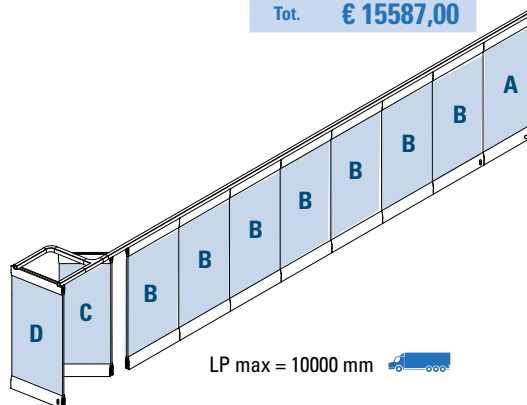

LP max = 10000 mm

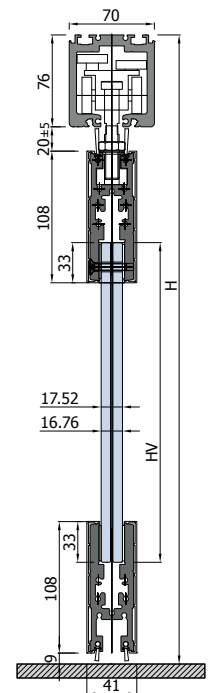
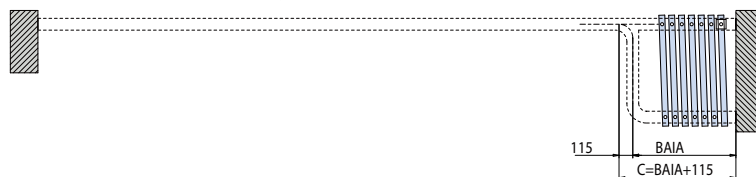

- Indicare sempre il verso di apertura, lo spessore del vetro e mandare il disegno fatto con [MY METALGLAS](#) al momento dell'ordine
- Please specify always opening direction, glass thickness and send technical drawing from [MY METALGLAS](#) when ordering
- Bitte immer Öffnungsrichtung, Glasdicke und technische Zeichnung von [MY METALGLAS](#) bei der Bestellung angeben

MIS

- Tagliato a misura del cliente
- Custom length
- Nach Mass geschnitten

> SET 10

- Prezzo su richiesta
- Price on request
- Preis auf Anfrage

- Progettazione configurazioni speciali da € 200 a € 600 netto
- Special design from € 200 till € 600 net
- Spezielle planung ab € 200 bis € 600 Netto



- Specificare se per apertura a destra o a sinistra
- Please specify always opening direction
- Bitte immer Öffnungsrichtung angeben

POS.	PROD.	ART.	MIS.	Q.TÀ	FIN.	EURO
PA-600 OPTIONALS		▲ PARETI MOBILI 44/48				
PA-100, PA-113, L-112 e L-112-PA inclusi nel set PA-100, PA-113, L-112 and L-112-PA in set included PA-100, PA-113, L-112 und L-112-PA im Set enthalten						
C.87		PA-100 FIX-3000	3000 mm	1 pc	AN	431,00/pc 143,67 /m
		PA-100 FIX-6000	6000 mm	1 pc	AN	861,50/pc 143,58 /m
C.88		TAGLIO-PM • Costo per extra taglio misura binari • Extra cost track profiles cut to size • Aufpreis Laufschiene nach Mass geschnitten		1 pc		52,00/pc
C.89	SX DX	PA-108-DX PA-108-SX • Altre baie disponibili Other parking bays ▶224		1 pc	AN	1221,30/pc
C.90	SX DX	PA-109-DX PA-109-SX • Altre baie disponibili Other parking bays ▶224		1 pc	AN	1221,30/pc
C.91		L-112-PA • For panel D		1 pc	CS	34,70/pc
C.92		L-112 • For panel A - B - C		1 pc	CS	34,70/pc
C.93		PA-113		1 pc	AN	51,00/pc
C.94		WRU-M 80/50 MT5		5 mt		77,50/pc 15,50 /m
C.94.1		WRU-C-BUMP-MT12		12 mt		247,30/pc 20,61 /m
C.95						
C.96						
C.97		PA-600 ANTA A		1 pc		1368,50/pc
C.98		PA-600 ANTA B		1 pc		1175,70/pc
C.99		PA-600 ANTA C		1 pc		1173,30/pc
C.100		PA-600 ANTA D		1 pc		1168,50/pc

PA-630-1P (1 porta | 1 door | 1 Tür)
Scorrevoli a parcheggio | Sliding stacking systems | Ganzglas-Schiebewandsysteme

► PARETI MOBILI 50/57

C.101

- Set compresi di binario, profili anta e pozzetti a terra
- Set with panel profiles, rail and floor sockets
- Set mit Flügelprofile, Laufschiene und Bodenbuchse

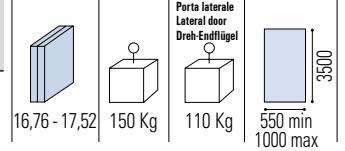

PA-630-SET4-1P	4 panels	AN	€ 9010,30
PA-108 / PA-109		AN	€ 1221,30
		Tot.	€ 10231,60

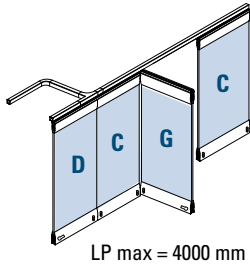

PA-630-SET5-1P	5 panels	AN	€ 10703,00
PA-108 / PA-109		AN	€ 1221,30
		Tot.	€ 11924,30

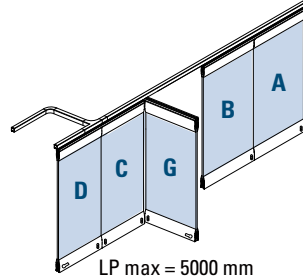

PA-630-SET6-1P	6 panels	AN	€ 12550,30
PA-108 / PA-109		AN	€ 1221,30
		Tot.	€ 13771,60

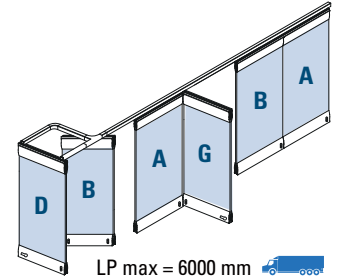

PA-630-SET7-1P	7 panels	AN	€ 14094,50
PA-108 / PA-109		AN	€ 1221,30
		Tot.	€ 15315,80

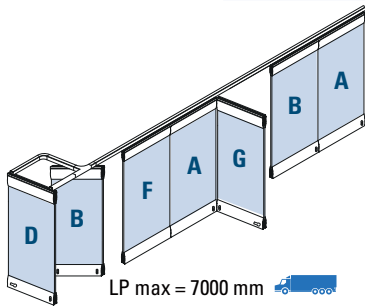

PA-630-SET8-1P	8 panels	AN	€ 16094,00
PA-108 / PA-109		AN	€ 1221,30
		Tot.	€ 17315,30

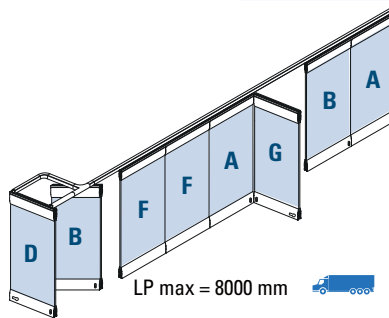

PA-630-SET9-1P	9 panels	AN	€ 17637,00
PA-108 / PA-109		AN	€ 1221,30
		Tot.	€ 18858,30

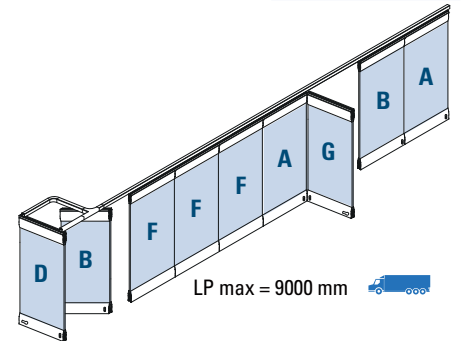

PA-630-SET10-1P	10 panels	AN	€ 19330,00
PA-108 / PA-109		AN	€ 1221,30
		Tot.	€ 20551,30

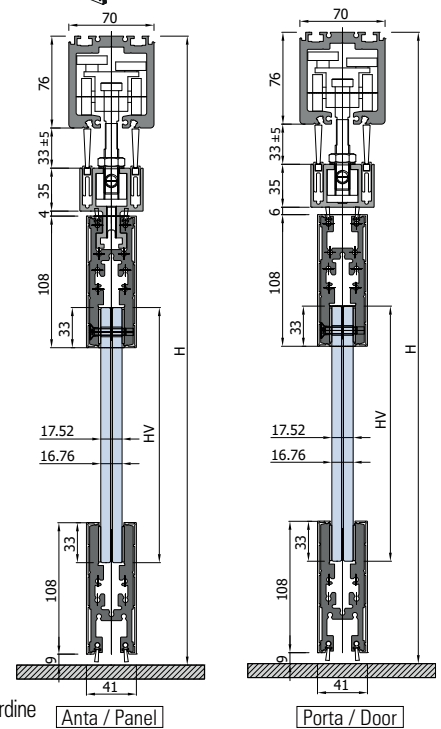
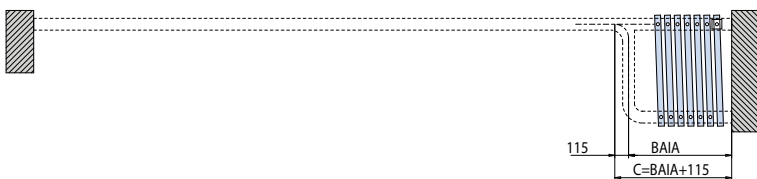
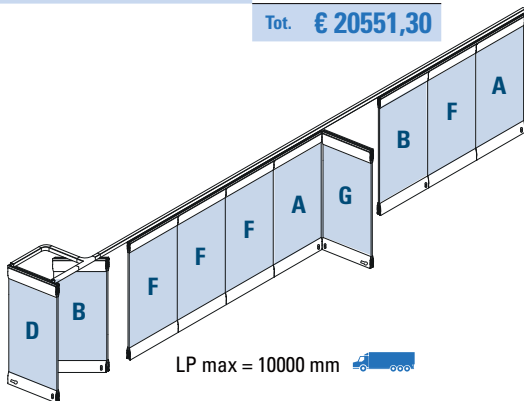

- Indicare sempre il verso di apertura, lo spessore del vetro e mandare il disegno fatto con **MY METALGLAS** al momento dell'ordine
- Please specify always opening direction, glass thickness and send technical drawing from **MY METALGLAS** when ordering
- Bitte immer Öffnungsrichtung, Glasdicke und technische Zeichnung von **MY METALGLAS** bei der Bestellung angeben

MIS

- Tagliato a misura del cliente
- Custom length
- Nach Mass geschnitten

> SET 10

- Prezzo su richiesta
- Price on request
- Preis auf Anfrage

- Progettazione configurazioni speciali da € 200 a € 600 netto
- Special design from € 200 till € 600 net
- Spezielle planung ab € 200 bis € 600 Netto



- Specificare se per apertura a destra o a sinistra
- Please specify always opening direction
- Bitte immer Öffnungsrichtung angeben

PA-630-2P (2 porte | 2 doors | 2 Türen)

Scorrevoli a parcheggio | Sliding stacking systems | Ganzglas-Schiebewandsysteme

PARETI MOBILI 50/57
C.102

- Set compresi di binario, profili anta e pozzetti a terra
- Set with panel profiles, rail and floor sockets
- Set mit Flügelprofile, Laufschiene und Bodenbuchse

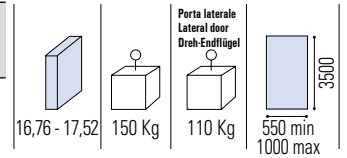

PA-630-SET4-2P 4 panels	AN	€ 10000,00
PA-108 / PA-109	AN	€ 1221,30
Tot.		€ 11221,30

PA-630-SET5-2P 5 panels	AN	€ 11991,00
PA-108 / PA-109	AN	€ 1221,30
Tot.		€ 13212,30

PA-630-SET6-2P 6 panels	AN	€ 13838,00
PA-108 / PA-109	AN	€ 1221,30
Tot.		€ 15059,30

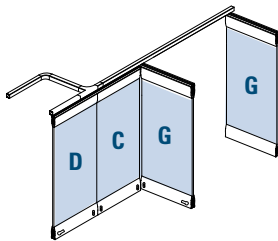

LP max = 4000 mm

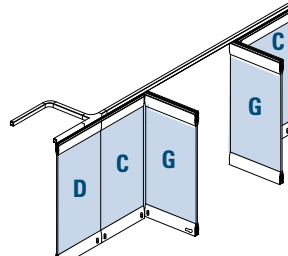

LP max = 5000 mm

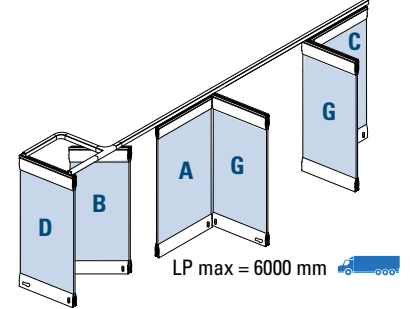

LP max = 6000 mm

PA-630-SET7-2P 7 panels	AN	€ 15380,30
PA-108 / PA-109	AN	€ 1221,30
Tot.		€ 16601,60

PA-630-SET8-2P 8 panels	AN	€ 17280,00
PA-108 / PA-109	AN	€ 1221,30
Tot.		€ 18501,30

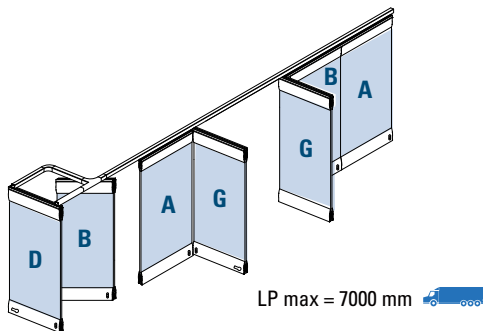

LP max = 7000 mm

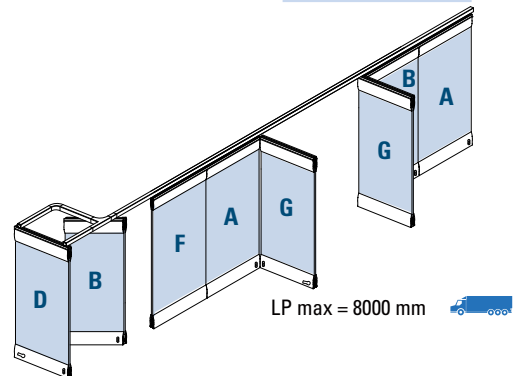

LP max = 8000 mm

PA-630-SET9-2P 9 panels	AN	€ 18922,50
PA-108 / PA-109	AN	€ 1221,30
Tot.		€ 20143,80

PA-630-SET10-2P 10 panels	AN	€ 21230,00
PA-108 / PA-109	AN	€ 1221,30
Tot.		€ 22451,30

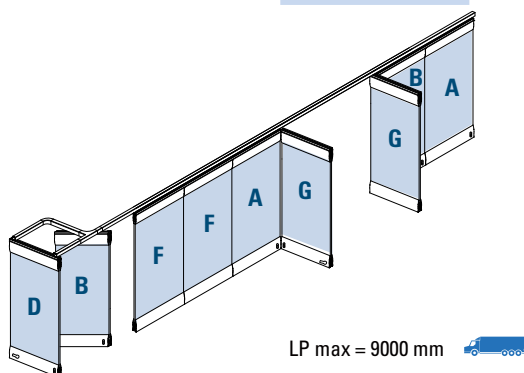

LP max = 9000 mm

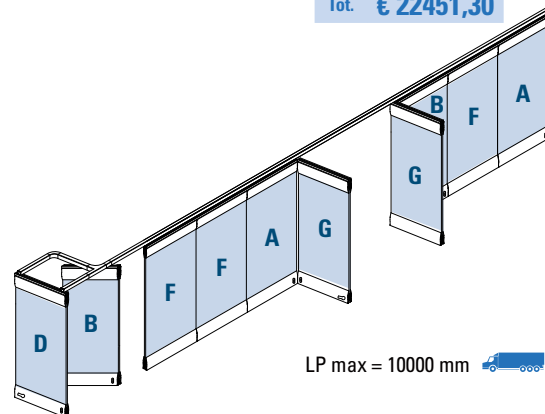

LP max = 10000 mm

- Indicare sempre il verso di apertura, lo spessore del vetro e mandare il disegno fatto con [MY METALGLAS](#) al momento dell'ordine
- Please specify always opening direction, glass thickness and send technical drawing from [MY METALGLAS](#) when ordering
- Bitte immer Öffnungsrichtung, Glasdicke und technische Zeichnung von [MY METALGLAS](#) bei der Bestellung angeben

- Trasporto fuori standard. Vedi condizioni di vendita
- Non-standard transport. See sales conditions
- Sondertransport. Siehe AGB

POS.	PROD.	ART.	MIS.	Q.TÀ	FIN.	EURO
PA-630 OPTIONALS		▲ PARETI MOBILI 50/57				
PA-100, PA-113, L-112 e L-112-PA inclusi nel set PA-100, PA-113, L-112 and L-112-PA in set included PA-100, PA-113, L-112 und L-112-PA im Set enthalten						
C.103		PA-100 FIX-3000	3000 mm	1 pc	AN	431,00/pc 143,67 /m
		PA-100 FIX-6000	6000 mm	1 pc	AN	861,50/pc 143,58 /m
C.104		TAGLIO-PM • Costo per extra taglio misura binari • Extra cost track profiles cut to size • Aufpreis Laufschiene nach Mass geschnitten		1 pc		52,00/pc
C.105	SX DX	PA-108-DX PA-108-SX • Altre baie disponibili Other parking bays ▶224		1 pc	AN	1221,30/pc
C.106	SX DX	PA-109-DX PA-109-SX • Altre baie disponibili Other parking bays ▶224		1 pc	AN	1221,30/pc
C.107		L-112-PA • For panel D and G		1 pc	CS	34,70/pc
C.108		L-112 • For panel A - B - C - F		1 pc	CS	34,70/pc
C.109		PA-215		1 pc	IX	63,70/pc
C.110		PA-113		1 pc	AN	51,00/pc
C.111		PA-300 CHIAVE		1 pc	AN	180,70/pc
C.112		WRU-M 80/50 MT5		5 mt		77,50/pc 15,50 /m
C.112.1		WRU-C-BUMP-MT12		12 mt		247,30/pc 20,61 /m
C.113						
C.114						

MIS





- Tagliato a misura del cliente
- Custom length
- Nach Mass geschnitten



- Specificare se per apertura a destra o a sinistra
- Please specify always opening direction
- Bitte immer Öffnungsrichtung angeben

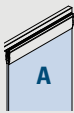
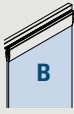
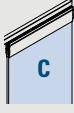

- Trasporto fuori standard. Vedi condizioni di vendita
- Non-standard transport. See sales conditions
- Sondertransport. Siehe AGB

POS.	PROD.	ART.	MIS.	Q.TÀ	FIN.	EURO
<i>C.115</i>		PA-630 ANTA A		1 pc		1616,50/pc
<i>C.116</i>		PA-630 ANTA B		1 pc		1422,00/pc
<i>C.117</i>		PA-630 ANTA C		1 pc		1614,50/pc
<i>C.118</i>		PA-630 ANTA D		1 pc		1416,30/pc
<i>C.119</i>		PA-630 ANTA F		1 pc		1424,00/pc
<i>C.120</i>		PA-630 ANTA G		1 pc		2628,30/pc

PA-200-ISO
Scorrevoli a parcheggio | Sliding stacking systems | Ganzglas-Schiebewandsysteme

► PARETI MOBILI 58/59

C.121

- Set compresi di binario, profili anta, pozzetti a terra, maniglia e cilindro
- Set with panel profiles, rail, floor sockets, handle and cylinder
- Set mit Flügelprofile, Laufschiene, Bodenbuchse, Türgriffe und Zylinder

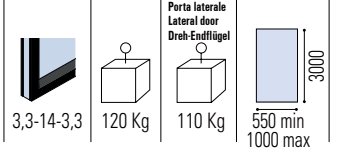

PA-200-ISO SET 3	3 panels	AN	€ 3921,00
PA-108 / PA-109		AN	€ 1221,30
		Tot.	€ 5142,30

PA-200-ISO SET 4	4 panels	AN	€ 5359,70
PA-108 / PA-109		AN	€ 1221,30
		Tot.	€ 6581,00

PA-200-ISO SET 5	5 panels	AN	€ 6374,50
PA-108 / PA-109		AN	€ 1221,30
		Tot.	€ 7595,80

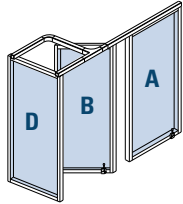

LP max = 3000 mm

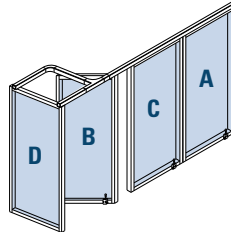

LP max = 4000 mm

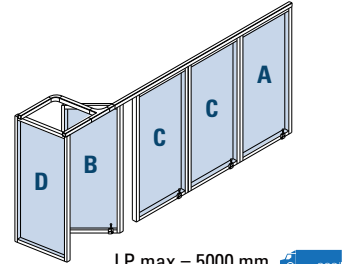

LP max = 5000 mm

PA-200-ISO SET 6	6 panels	AN	€ 7383,00
PA-108 / PA-109		AN	€ 1221,30
		Tot.	€ 8604,30

PA-200-ISO SET 7	7 panels	AN	€ 8822,00
PA-108 / PA-109		AN	€ 1221,30
		Tot.	€ 10043,30

PA-200-ISO SET 8	8 panels	AN	€ 9836,30
PA-108 / PA-109		AN	€ 1221,30
		Tot.	€ 11057,60

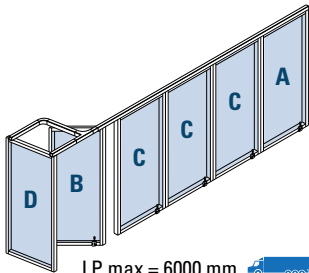

LP max = 6000 mm

LP max = 7000 mm

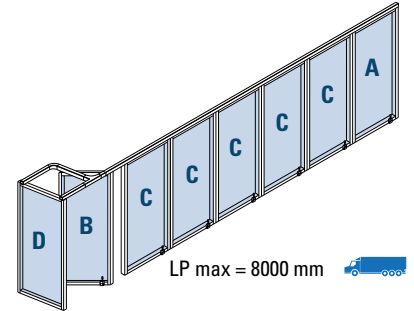

LP max = 8000 mm

PA-200-ISO SET 9	9 panels	AN	€ 11275,30
PA-108 / PA-109		AN	€ 1221,30
		Tot.	€ 12496,60

PA-200-ISO SET 10	10 panels	AN	€ 12284,00
PA-108 / PA-109		AN	€ 1221,30
		Tot.	€ 13505,30

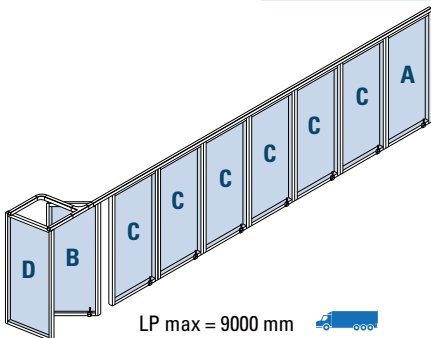

LP max = 9000 mm

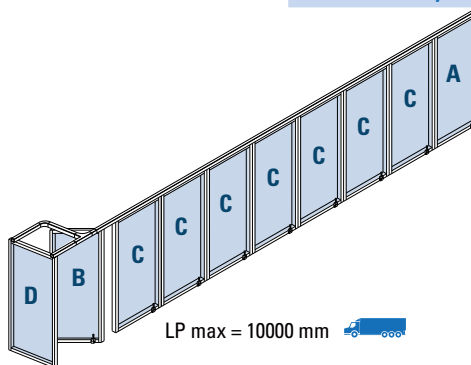

LP max = 10000 mm

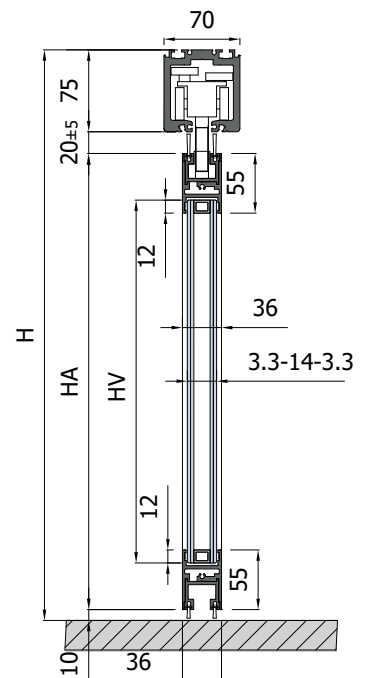
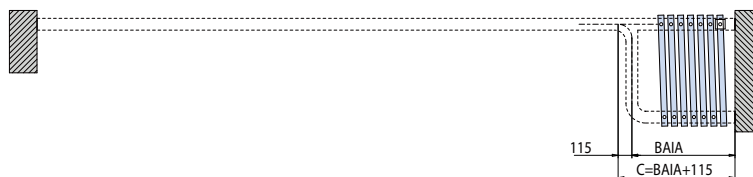

- Indicare sempre il verso di apertura e mandare il disegno fatto con **MY METALGLAS** al momento dell'ordine
- Please specify always opening direction and send technical drawing from **MY METALGLAS** when ordering
- Bitte immer Öffnungsrichtung und technische Zeichnung von **MY METALGLAS** bei der Bestellung angeben

MIS

- Tagliato a misura del cliente
- Custom length
- Nach Mass geschnitten

SET 10

- Tagliato dal cliente
- Cut by installer
- Schnitt bauseitig

> SET 10

- Prezzo su richiesta
- Price on request
- Preis auf Anfrage
- Progettazione configurazioni speciali da € 200 a € 600 netto
- Special design from € 200 till € 600 net
- Spezielle planung ab € 200 bis € 600 Netto



- Specificare se per apertura a destra o a sinistra
- Please specify always opening direction
- Bitte immer Öffnungsrichtung angeben

POS.	PROD.	ART.	MIS.	Q.TÀ	FIN.	EURO	
PA-200-ISO OPTIONALS							▲ PARETI MOBILI 58/59
PA-100, PA-113, BG-ISO-07 e BGF-10 inclusi nel set PA-100, PA-113, BG-ISO-07 and BGF-10 in set included PA-100, PA-113, BG-ISO-07 und BGF-10 im Set enthalten							
C.122		PA-100 FIX-3000	3000 mm	1 pc	AN	431,00 /pc 143,67 /m	
		PA-100 FIX-6000	 6000 mm	1 pc	AN	861,50 /pc 143,58 /m	
C.123		TAGLIO-PM • Costo per extra taglio misura binari • Extra cost track profiles cut to size • Aufpreis Laufschiene nach Mass geschnitten		1 pc		52,00 /pc	
C.124		PA-108-DX PA-108-SX • Altre baie disponibili Other parking bays ▶224		1 pc	AN	1221,30 /pc	
C.125		PA-109-DX PA-109-SX • Altre baie disponibili Other parking bays ▶224		1 pc	AN	1221,30 /pc	
C.126		PA-113		1 pc	AN	51,00 /pc	
C.127		BGF-ISO-U L=3000 mm		1 pc	AN	137,30 /pc	
C.128		BGF-ISO-L L=3000 mm		1 pc	AN	107,50 /pc	
C.129		PA-200-ISO ANTA A  L = 1000 x 3000 mm		1 pc	AN	1137,70 /pc	
C.130		PA-200-ISO ANTA B  L = 1000 x 3000 mm		1 pc	AN	1061,00 /pc	
C.131		PA-200-ISO ANTA C  L = 1000 x 3000 mm		1 pc	AN	1034,70 /pc	
C.132		PA-200-ISO ANTA D • With handle and cylinder  L = 1000 x 3000 mm		1 pc	AN	1177,70 /pc	
C.133		BG-ISO-07		1 pc	AN	95,50 /pc	
C.134		BGF-10		1 pc		6,30 /pc	



- Trasporto fuori standard. Vedi condizioni di vendita
- Non-standard transport. See sales conditions
- Sondertransport. Siehe AGB

do-it-yourself

- Profili anta forniti in misura FIX L = 1000x3000 mm da tagliare cliente secondo schema [MY METALGLAS](#)
- Panel profiles supplied in standard length 1000x3000 mm cut by installer according to [MY METALGLAS](#) configurator
- Flügelprofile erhältlich in Fixlängen von 1000x3000 mm schnitt bauseitig gemäss Konfigurator [MY METALGLAS](#)

POS.	PROD.	ART.	MIS.	Q.TÀ	FIN.	EURO
Accessori per sistemi a libro / parcheggio <i>Accessories for folding / stacking systems Zubehöre falt / Schiebewände-Systeme</i>						▲ PARETI MOBILI 63
C.284		PA-113		1 pc	AN	51,00/pc
C.285		PA-115 • Curva 90° • 90° curve • 90° Kurve		1 pc	AN	424,70/pc
C.286		L-112-PA		1 pc	CS	34,70/pc
C.287		L-112		1 pc	CS	34,70/pc
C.288		V-039 L = 3000 mm		1 pc		43,30/pc
		V-039-MIX L = 3000 mm		min 10 pcs		30,50/pc
C.289						
C.290						
C.291						
Per serrature consultare il listino Indoor For locks check the Indoor price list Für Schlösser siehe Indoor Preisliste						
Baie di parcheggio <i>Parking areas Parkräume</i>						▲ PARETI MOBILI 60/62
C.292		PA-108-DX PA-108-SX		1 pc	AN	1221,30/pc
C.293		PA-109-DX PA-109-SX		1 pc	AN	1221,30/pc
C.294		PA-119-B-DX PA-119-B-SX		1 pc	AN	3094,30/pc
C.295		PA-119-C-DX PA-119-C-SX		1 pc	AN	1335,70/pc
C.296		PA-119-D-DX PA-119-D-SX		1 pc	AN	1335,70/pc
C.297		PA-119-F-DX PA-119-F-SX		1 pc	AN	1909,30/pc

MIX

- Minimo ordine quantità indicata
- Minimum order indicated quantity
- Mindestbestellmenge angeführten Menge



- Specificare se per apertura a destra o a sinistra
- Please specify always opening direction
- Bitte immer Öffnungsrichtung angeben

POS.	PROD.	ART.	MIS.	Q.TÀ	FIN.	EURO
C.298		PA-119-G-DX PA-119-G-SX		1 pc	AN	2790,50/pc
C.299		PA-119-H-DX PA-119-H-SX		1 pc	AN	2882,70/pc
C.300		PA-119-I-DX PA-119-I-SX		1 pc	AN	2782,50/pc
C.301		PA-119-L-DX PA-119-L-SX		1 pc	AN	2789,30/pc
C.302		PA-119-M-DX PA-119-M-SX		1 pc	AN	2003,50/pc
C.303		PA-119-N-DX PA-119-N-SX		1 pc	AN	2170,50/pc
C.304		PA-119-O-DX PA-119-O-SX		1 pc	AN	4356,30/pc
		PA-119-P-DX PA-119-P-SX		1 pc	AN	1781,00/pc

PA-250

Scorrevoli a libro | Sliding folding systems | Falt-Schiebewandssysteme

► PARETI MOBILI 66/70

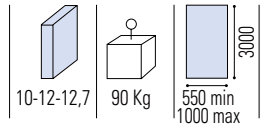

C.135

- Set compresi di profili anta, binario e profilo a terra
- Set with panel profiles, rail and floor profile
- Set mit Flügelprofile, Laufschiene und Bodenschiene

PA-250 SET 2	LB MAX = 2000 mm
2 ante panels	AN € 2325,30

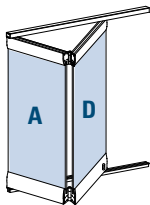

PA-250 SET 3	LB MAX = 3000 mm
3 ante panels	AN € 3372,00

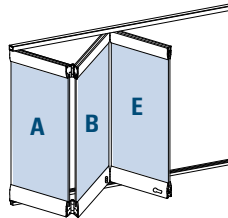

PA-250 SET 4	LB MAX = 4000 mm
4 ante panels	AN € 4825,50

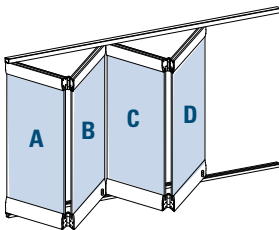

PA-250 SET 5	LB MAX = 5000 mm
5 ante panels	AN € 5674,00

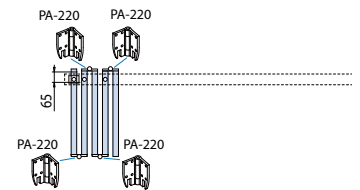
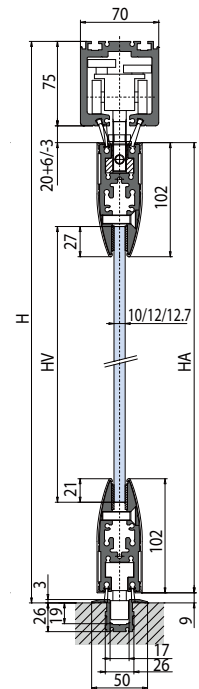
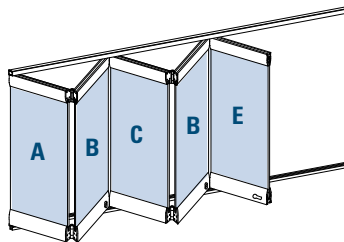

PA-250 SET 6	LB MAX = 6000 mm
6 ante panels	AN € 6535,00

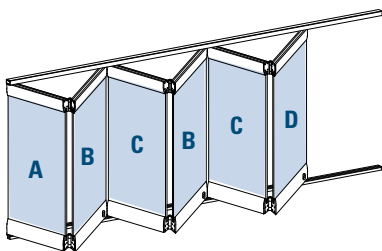

PA-250 SET 7	LB MAX = 6000 mm
7 ante panels	AN € 7078,70

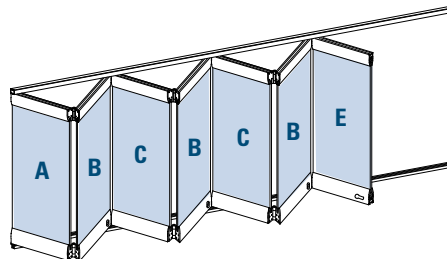

PA-250-ANTA F	LB MAX = 1200 mm
Porta laterale fissa Fixed lateral pivoted door Fest Drehflügel	AN € 961,00

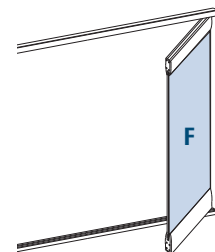

- Indicare sempre il verso di apertura, lo spessore del vetro e mandare il disegno fatto con **MY METALGLAS** al momento dell'ordine
- Please specify always opening direction, glass thickness and send technical drawing from **MY METALGLAS** when ordering
- Bitte immer Öffnungsrichtung, Glasdicke und technische Zeichnung von **MY METALGLAS** bei der Bestellung angeben

MIS

- Tagliato a misura del cliente
- Custom length
- Nach Mass geschnitten

> SET 7

- Prezzo su richiesta
- Price on request
- Preis auf Anfrage



- Trasporto fuori standard. Vedi condizioni di vendita
- Non-standard transport. See sales conditions
- Sondertransport. Siehe AGB

POS.	PROD.	ART.	MIS.	Q.TÀ	FIN.	EURO
PA-250 OPTIONALS		▲ PARETI MOBILI 66/70				
PA-100 e L-113 inclusi nel set PA-100 and L-113 in set included PA-100 und L-113 im Set enthalten						
C.136		PA-100 FIX-3000	3000 mm	1 pc	AN	431,00 /pc 143,67 /m
		PA-100 FIX-6000	6000 mm	1 pc	AN	861,50 /pc 143,58 /m
C.137		L-113 FIX-3000	3000 mm	1 pc	AN	114,00 /pc 38,00 /m
		L-113 FIX-6000	6000 mm	1 pc	AN	227,30 /pc 37,88 /m
C.138		L-110 FIX-3000	3000 mm	1 pc	AN	71,50 /pc 23,83 /m
		L-110 FIX-6000	6000 mm	1 pc	AN	142,50 /pc 23,75 /m
C.139		L-115 FIX-3000	3000 mm	1 pc	AN	212,10 /pc 70,70 /m
		L-115 FIX-6000	6000 mm	1 pc	AN	424,20 /pc 70,70 /m
C.140		TAGLIO-PM • Costo per extra taglio misura binari • Extra cost track profiles cut to size • Aufpreis Laufschiene nach Mass geschnitten		1 pc		52,00 /pc
C.141		PA-113		1 pc	AN	51,00 /pc
C.142		WRU-M 80/50 MT5				77,50 /pc 15,50 /m
C.142.1		WRU-C-BUMP-MT12				247,30 /pc 20,61 /m
C.143						
C.144						
C.145		PA-250 ANTA A		1 pc	AN	922,30 /pc
C.147		PA-250 ANTA B		1 pc	AN	1029,70 /pc
C.148		PA-250 ANTA C		1 pc	AN	726,00 /pc
C.149		PA-250 ANTA D		1 pc	AN	922,30 /pc
C.150		PA-250 ANTA E		1 pc	AN	765,00 /pc

PA-450
Scorrevoli a libro | Sliding folding systems | Falt-Schiebewandssysteme

► PARETI MOBILI 72/73

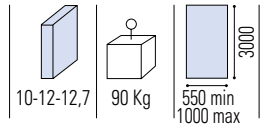

C.160

- Set compresi di profili anta, binario e profilo a terra
- Set with panel profiles, rail and floor profile
- Set mit Flügelprofile, Laufschiene und Bodenschiene

PA-450 SET 2	LB MAX = 2000 mm
2 ante panels	AN € 2200,30

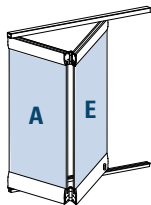

PA-450 SET 3	LB MAX = 3000 mm
3 ante panels	AN € 3118,70

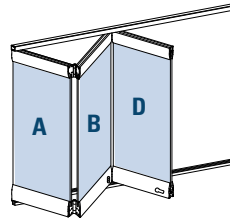

PA-450 SET 4	LB MAX = 4000 mm
4 ante panels	AN € 4465,50

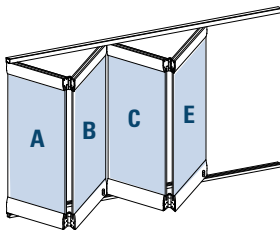

PA-450 SET 5	LB MAX = 5000 mm
5 ante panels	AN € 5194,70

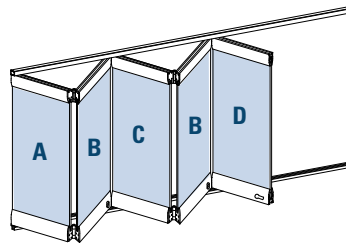

PA-450 SET 6	LB MAX = 6000 mm
6 ante panels	AN € 5980,00

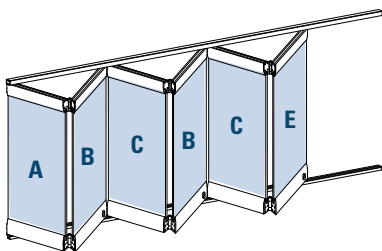

PA-450 SET 7	LB MAX = 6000 mm
7 ante panels	AN € 6897,00

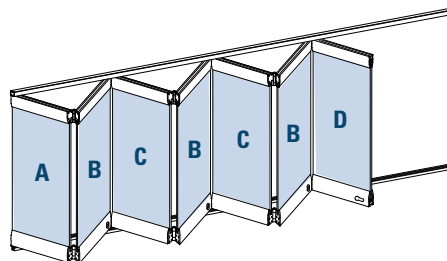

PA-450-ANTA F	L = 1200 mm
Porta laterale fissa Fixed lateral pivoted door Fest Drehflügel	AN € 973,30

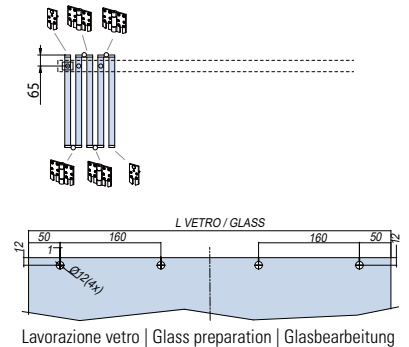
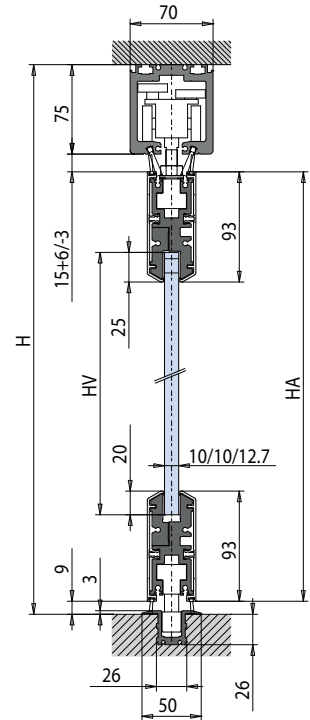
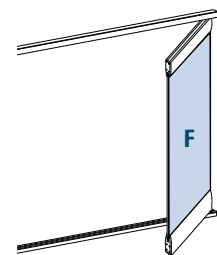

- Indicare sempre il verso di apertura, lo spessore del vetro e mandare il disegno fatto con **MY METALGLAS** al momento dell'ordine
- Please specify always opening direction, glass thickness and send technical drawing from **MY METALGLAS** when ordering
- Bitte immer Öffnungsrichtung, Glasdicke und technische Zeichnung von **MY METALGLAS** bei der Bestellung angeben

- MIS**
 - Tagliato dal cliente
 - Cut by installer
 - Schnitt bauseitig
- MIS**
 - Tagliato a misura del cliente
 - Custom length
 - Nach Mass geschnitten

- > SET 7**
 - Prezzo su richiesta
 - Price on request
 - Preis auf Anfrage
- MIS**
 - Trasporto fuori standard. Vedi condizioni di vendita
 - Non-standard trasport. See sales conditions
 - Sondertransport. Siehe AGB

POS.	PROD.	ART.	MIS.	Q.TÀ	FIN.	EURO
PA-450 OPTIONALS		▲ PARETI MOBILI 72/73				
PA-100 e L-113 inclusi nel set PA-100 and L-113 in set included PA-100 und L-113 im Set enthalten						
C.161		PA-100 FIX-3000	3000 mm	1 pc	AN	431,00 /pc 143,67 /m
		PA-100 FIX-6000	6000 mm	1 pc	AN	861,50 /pc 143,58 /m
C.162		L-113 FIX-3000	3000 mm	1 pc	AN	114,00 /pc 38,00 /m
		L-113 FIX-6000	6000 mm	1 pc	AN	227,30 /pc 37,88 /m
C.163		L-110 FIX-3000	3000 mm	1 pc	AN	71,50 /pc 23,83 /m
		L-110 FIX-6000	6000 mm	1 pc	AN	142,50 /pc 23,75 /m
C.164		L-115 FIX-3000	3000 mm	1 pc	AN	212,10 /pc 70,70 /m
		L-115 FIX-6000	6000 mm	1 pc	AN	424,20 /pc 70,70 /m
C.165		TAGLIO-PM • Costo per extra taglio misura binari • Extra cost track profiles cut to size • Aufpreis Laufschiene nach Mass geschnitten		1 pc		52,00 /pc
C.166		PA-113		1 pc	AN	51,00 /pc
C.167		WRU-M 80/50 MT5		5 mt		77,50 /pc 15,50 /m
C.167.1		WRU-C-BUMP-MT12		12 mt		247,30 /pc 20,61 /m
C.168						
C.169						
C.170		PA-450 ANTA A L = 1200 mm		1 pc	AN	888,70 /pc
C.171		PA-450 ANTA B L = 1200 mm		1 pc	AN	907,50 /pc
C.172		PA-450 ANTA C L = 1200 mm		1 pc	AN	656,30 /pc
C.173		PA-450 ANTA D L = 1200 mm		1 pc	AN	680,30 /pc
C.174		PA-450 ANTA E L = 1200 mm		1 pc	AN	833,70 /pc

do-it-yourself

- Profili anta forniti in misura FIX da tagliare cliente secondo schema [MY METALGLAS](#)
- Panel profiles supplied in FIX length cut by installer according to [MY METALGLAS](#) configurator
- Flügelprofile in Fixlängen schnitt bauseitig gemäss Konfigurator [MY METALGLAS](#)

PA-550
Scorrevoli a libro | Sliding folding systems | Falt-Schiebewandssysteme

► PARETI MOBILI 74/78

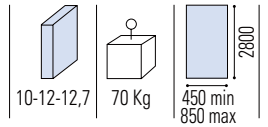

C.175

- Set compresi di profili anta, binario e profilo a terra
- Set with panel profiles, rail and floor profile
- Set mit Flügelprofile, Laufschiene und Bodenschiene

PA-550 SET 2	LB MAX = 2000 mm
2 ante panels	AN € 2036,30

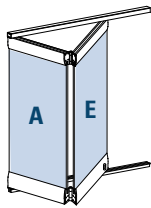

PA-550 SET 3	LB MAX = 3000 mm
3 ante panels	AN € 2758,50

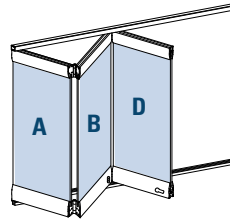

PA-550 SET 4	LB MAX = 4000 mm
4 ante panels	AN € 4021,70

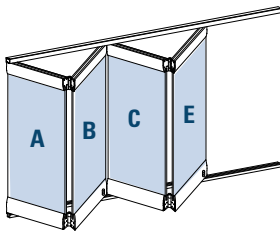

PA-550 SET 5	LB MAX = 5000 mm
5 ante panels	AN € 4592,70

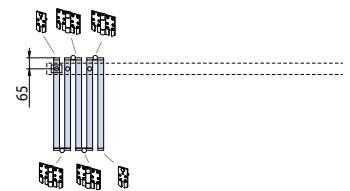
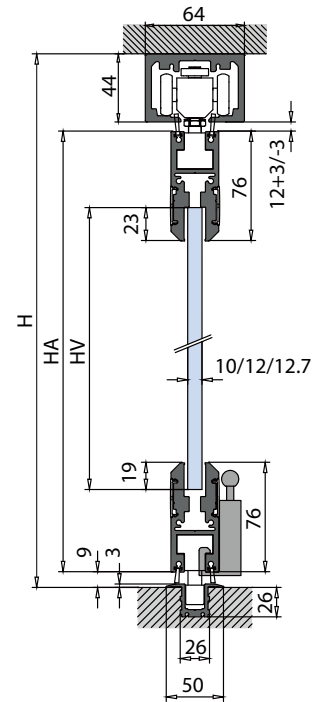
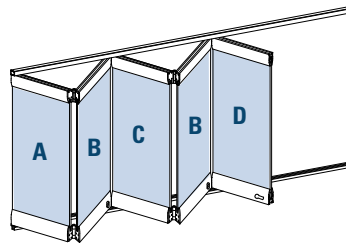

PA-550 SET 6	LB MAX = 6000 mm
6 ante panels	AN € 5412,50

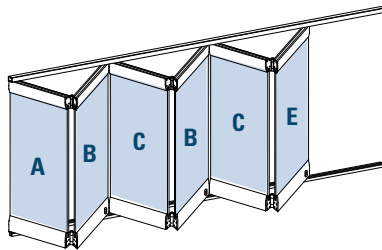

PA-550 SET 7	LB MAX = 6000 mm
7 ante panels	AN € 5983,30

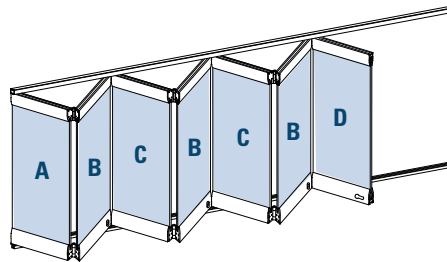

PA-550-ANTA F	L = 1000 mm
Porta laterale fissa Fixed lateral pivoted door Fest Drehflügel	AN € 815,00

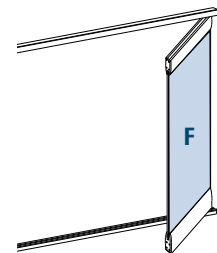

- Indicare sempre il verso di apertura, lo spessore del vetro e mandare il disegno fatto con **MY METALGLAS** al momento dell'ordine
- Please specify always opening direction, glass thickness and send technical drawing from **MY METALGLAS** when ordering
- Bitte immer Öffnungsrichtung, Glasdicke und technische Zeichnung von **MY METALGLAS** bei der Bestellung angeben

MIS
 • Tagliato dal cliente
 • Cut by installer
 • Schnitt bauseitig

MIS
 • Tagliato a misura del cliente
 • Custom length
 • Nach Mass geschnitten

> SET 7
 • Prezzo su richiesta
 • Price on request
 • Preis auf Anfrage

Trasporto
 • Trasporto fuori standard. Vedi condizioni di vendita
 • Non-standard trasport. See sales conditions
 • Sondertransport. Siehe AGB

POS.	PROD.	ART.	MIS.	Q.TÀ	FIN.	EURO
PA-550 ▲ PARETI MOBILI 74/78 OPTIONALS						
L-150,L-113, PA-502 e BGF-10 inclusi nel set L-150,L-113, PA-502 and BGF-10 in set included L-150,L-113, PA-502 und BGF-10 im Set enthalten						
C.176		L-150 FIX-3000	3000 mm	1 pc	AN	314,30/pc 104,77 /m
		L-150 FIX-6000	6000 mm	1 pc	AN	628,00/pc 104,67 /m
C.177		L-113 FIX-3000	3000 mm	1 pc	AN	114,00/pc 38,00 /m
		L-113 FIX-6000	6000 mm	1 pc	AN	227,30/pc 37,88 /m
C.178		L-110 FIX-3000	3000 mm	1 pc	AN	71,50/pc 23,83 /m
		L-110 FIX-6000	6000 mm	1 pc	AN	142,50/pc 23,75 /m
C.179		L-115 FIX-3000	3000 mm	1 pc	AN	212,10/pc 70,70 /m
		L-115 FIX-6000	6000 mm	1 pc	AN	424,20/pc 70,70 /m
C.180		TAGLIO-PM • Costo per extra taglio misura binari • Extra cost track profiles cut to size • Aufpreis Laufschiene nach Mass geschnitten		1 pc		52,00/pc
C.181		WRU-M 80/50 MT5		5 mt		77,50/pc 15,50 /m
C.181.1		WRU-C-BUMP-MT12		12 mt		247,30/pc 20,61 /m
C.182						
C.183						
C.184		PA-550 ANTA A L = 1000 mm		1 pc	AN	827,00/pc
C.185		PA-550 ANTA B L = 1000 mm		1 pc	AN	844,30/pc
C.186		PA-550 ANTA C L = 1000 mm		1 pc	AN	595,30/pc
C.187		PA-550 ANTA D L = 1000 mm		1 pc	AN	530,00/pc
C.188		PA-550 ANTA E L = 1000 mm		1 pc	AN	778,70/pc
C.189		PA-502		1 pc	AN	60,00/pc
C.190		BGF-10		1 pc		6,30/pc

do-it-yourself

- Profili anta forniti in misura FIX da tagliare cliente secondo schema [MY METALGLAS](#)
- Panel profiles supplied in FIX length cut by installer according to [MY METALGLAS](#) configurator
- Flügelprofile in Fixlängen schnitt bauseitig gemäss Konfigurator [MY METALGLAS](#)

PA-650

Scorrevoli a libro | Sliding folding systems | Falt-Schiebewandssysteme

► PARETI MOBILI 80/81

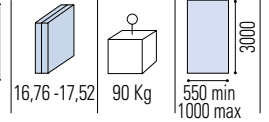

C.191

- Set compresi di profili anta, binario e profilo a terra
- Set with panel profiles, rail and floor profile
- Set mit Flügelprofile, Laufschiene und Bodenschiene

PA-650 SET 2	LB MAX = 2000 mm
2 ante panels	AN € 3053,50

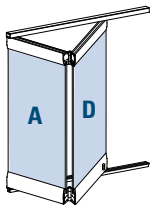

PA-650 SET 3	LB MAX = 3000 mm
3 ante panels	AN € 4483,70

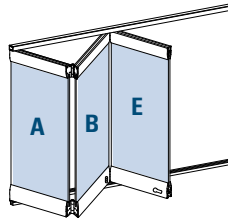

PA-650 SET 4	LB MAX = 4000 mm
4 ante panels	AN € 6299,50

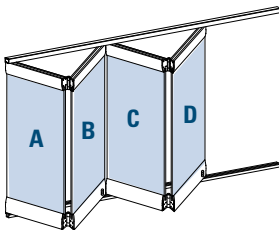

PA-650 SET 5	LB MAX = 5000 mm
5 ante panels	AN € 7521,30

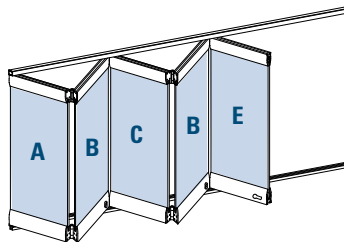

PA-650 SET 6	LB MAX = 6000 mm
6 ante panels	AN € 8715,70

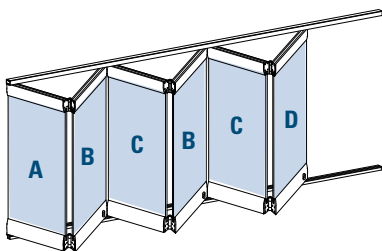

PA-650 SET 7	LB MAX = 6000 mm
7 ante panels	AN € 9588,00

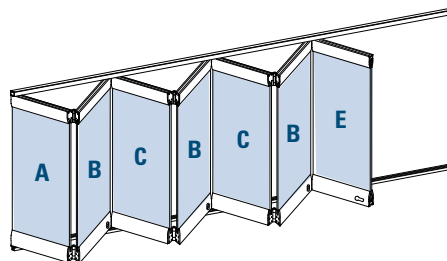

PA-650-ANTA F	LB MAX = 1000 mm
Porta laterale fissa Fixed lateral pivoted door Fest Drehflügel	AN € 1297,30

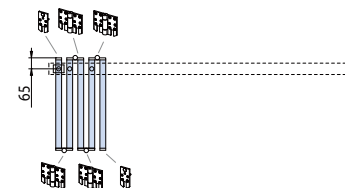
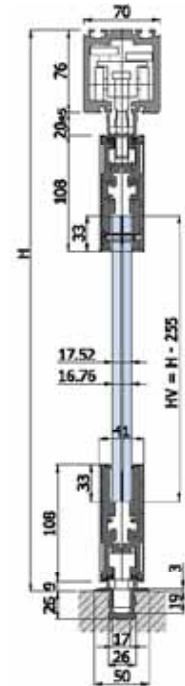
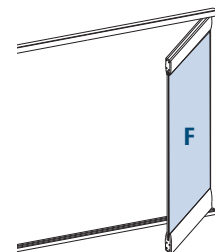

- Indicare sempre il verso di apertura, lo spessore del vetro e mandare il disegno fatto con **MY METALGLAS** al momento dell'ordine
- Please specify always opening direction, glass thickness and send technical drawing from **MY METALGLAS** when ordering
- Bitte immer Öffnungsrichtung, Glasdicke und technische Zeichnung von **MY METALGLAS** bei der Bestellung angeben

MIS

- Tagliato a misura del cliente
- Custom length
- Nach Mass geschnitten

> SET 7

- Prezzo su richiesta
- Price on request
- Preis auf Anfrage



- Trasporto fuori standard. Vedi condizioni di vendita
- Non-standard transport. See sales conditions
- Sondertransport. Siehe AGB

POS.	PROD.	ART.	MIS.	Q.TÀ	FIN.	EURO
PA-650 OPTIONALS		▲ PARETI MOBILI 80/81				
PA-100 e L-113 inclusi nel set PA-100 and L-113 in set included PA-100 und L-113 im Set enthalten						
C.192		PA-100 FIX-3000	3000 mm	1 pc	AN	431,00 /pc 143,67 /m
		PA-100 FIX-6000	6000 mm	1 pc	AN	861,50 /pc 143,58 /m
C.193		L-113 FIX-3000	3000 mm	1 pc	AN	114,00 /pc 38,00 /m
		L-113 FIX-6000	6000 mm	1 pc	AN	227,30 /pc 37,88 /m
C.194		L-110 FIX-3000	3000 mm	1 pc	AN	71,50 /pc 23,83 /m
		L-110 FIX-6000	6000 mm	1 pc	AN	142,50 /pc 23,75 /m
C.195		L-115 FIX-3000	3000 mm	1 pc	AN	212,10 /pc 70,70 /m
		L-115 FIX-6000	6000 mm	1 pc	AN	424,20 /pc 70,70 /m
C.196		TAGLIO-PM • Costo per extra taglio misura binari • Extra cost track profiles cut to size • Aufpreis Laufschiene nach Mass geschnitten		1 pc		52,00 /pc
C.197		PA-113		1 pc	AN	51,00 /pc
C.198		WRU-M 80/50 MT5		5 mt		77,50 /pc 15,50 /m
C.198.1		WRU-C-BUMP-MT12		12 mt		247,30 /pc 20,61 /m
C.199						
C.200						
C.201		PA-650 ANTA A		1 pc	AN	1342,50 /pc
C.202		PA-650 ANTA B		1 pc	AN	1381,00 /pc
C.203		PA-650 ANTA C		1 pc	AN	1034,00 /pc
C.204		PA-650 ANTA D		1 pc	AN	1273,30 /pc
C.205		PA-650 ANTA E		1 pc	AN	1038,30 /pc

L-1500

Scorrevoli a libro | Sliding folding systems | falt-Schiebewandssysteme

► PARETI MOBILI 82/83

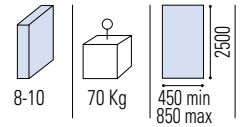

C.206

- Set ante, binario e profilo a terra inclusi
- Set panels with rail and floor profile included
- Flügelset mit Laufschiene und Bodenschiene enthalten

L-1500 SET 1	LB MAX = 2000 mm	
	AN	NS
2 ante panels	€ 1708,30	€ 2426,50

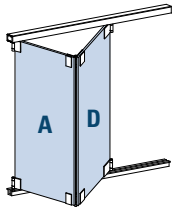

L-1500 SET 2	LB MAX = 3000 mm	
	AN	NS
3 ante panels	€ 1960,50	€ 2772,70

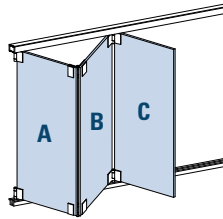

L-1500 SET 3	LB MAX = 4000 mm	
	AN	NS
4 ante panels	€ 3204,50	€ 4158,70

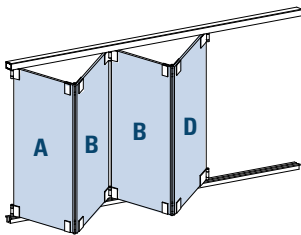

L-1500 SET 4	LB MAX = 5000 mm	
	AN	NS
5 ante panels	€ 3302,00	€ 4531,00

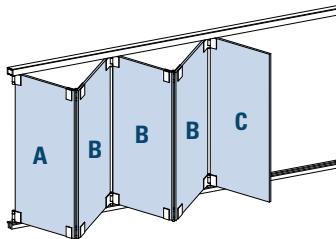

L-1500 SET 5	LB MAX = 6000 mm	
	AN	NS
6 ante panels	€ 4012,50	€ 5852,70

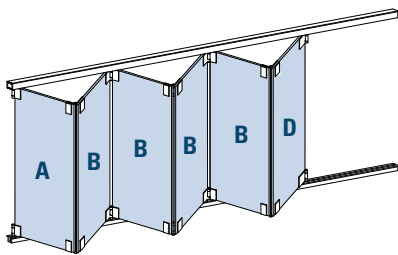

L-1500-ANTA F	LB MAX = 850 mm	
	AN	NS
Porta laterale fissa Fixed lateral pivoted door Fest Drehflügel	€ 470,30	€ 909,50

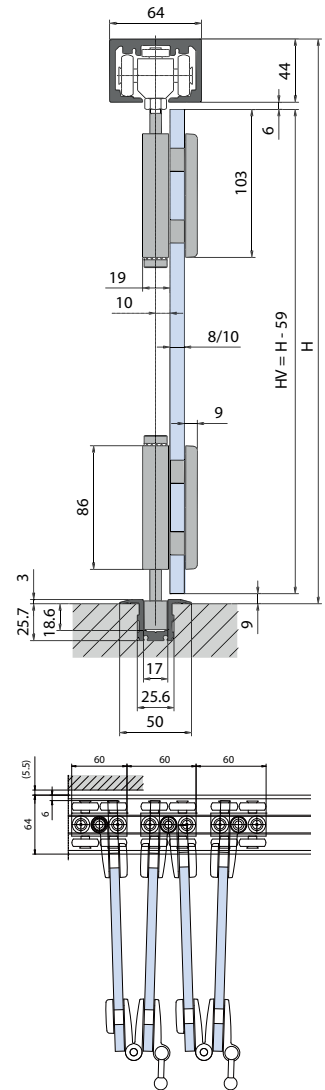
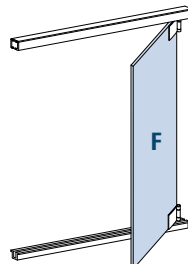

- Indicare sempre il verso di apertura, lo spessore del vetro e mandare il disegno fatto con **MY METALGLAS** al momento dell'ordine
- Please specify always opening direction, glass thickness and send technical drawing from **MY METALGLAS** when ordering
- Bitte immer Öffnungsrichtung, Glasdicke und technische Zeichnung von **MY METALGLAS** bei der Bestellung angeben

MIS

- Tagliato a misura del cliente
- Custom length
- Nach Mass geschnitten

> SET 5

- Prezzo su richiesta
- Price on request
- Preis auf Anfrage



- Trasporto fuori standard. Vedi condizioni di vendita
- Non-standard transport. See sales conditions
- Sondertransport. Siehe AGB

POS.	PROD.	ART.	MIS.	Q.TÀ	FIN.	EURO	FIN.	EURO
L-1500 OPTIONALS		▲ PARETI MOBILI 86/87						
L-150 e L-113 inclusi nel set L-150 and L-113 in set included L-150 und L-113 im Set enthalten								
C.207		L-150 FIX-3000	3000 mm	1 pc	AN	314,30 /pc 104,77 /m		
		L-150 FIX-6000	6000 mm	1 pc	AN	628,00 /pc 104,67 /m		
C.208		L-113 FIX-3000	3000 mm	1 pc	AN	114,00 /pc 38,00 /m		
		L-113 FIX-6000	6000 mm	1 pc	AN	227,30 /pc 37,88 /m		
C.209		L-110 FIX-3000	3000 mm	1 pc	AN	71,50 /pc 23,83 /m		
		L-110 FIX-6000	6000 mm	1 pc	AN	142,50 /pc 23,75 /m		
C.210		L-115 FIX-3000	3000 mm	1 pc	AN	212,10 /pc 70,70 /m		
		L-115 FIX-6000	6000 mm	1 pc	AN	424,20 /pc 70,70 /m		
C.211		TAGLIO-PM • Costo per extra taglio misura binari • Extra cost track profiles cut to size • Aufpreis Laufschiene nach Mass geschnitten		1 pc		52,00 /pc		
C.212		WRU-M 80/50 MT5				77,50 /pc 15,50 /m		
C.212.1		WRU-C-BUMP-MT12				247,30 /pc 20,61 /m		
C.213								
C.214								
C.215		L-201		1 pc	AN	155,30 /pc	NS	217,00 /pc
C.216		L-202		1 pc	AN	349,00 /pc	NS	488,70 /pc
C.217		L-203		1 pc	AN	186,30 /pc	NS	260,50 /pc
C.218		L-204		1 pc	AN	380,00 /pc	NS	532,30 /pc
C.219		L-205		1 pc	AN	186,30 /pc	NS	252,70 /pc
C.220		L-206		1 pc	AN	210,50 /pc	NS	287,00 /pc
C.221		L-209		1 pc	AN	34,70 /pc		

L-1000

Scorrevoli a libro | Sliding folding systems | falt-Schiebewandssysteme

► PARETI MOBILI 84/85

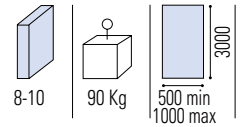

C.222

- Set ante, binario e profilo a terra inclusi
- Set panels with rail and floor profile included
- Flügelset mit Laufschiene und Bodenschiene enthalten

L-1000 SET 1

LB MAX = 2000 mm

2 ante | panels

AN	NS
€ 1976,30	€ 2053,70

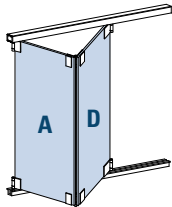

L-1000 SET 2

LB MAX = 3000 mm

3 ante | panels

AN	NS
€ 2351,00	€ 2443,70

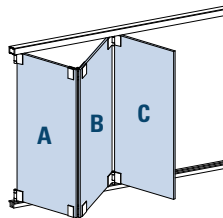

L-1000 SET 3

LB MAX = 4000 mm

4 ante | panels

AN	NS
€ 3919,70	€ 4070,00

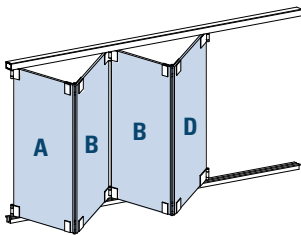

L-1000 SET 4

LB MAX = 5000 mm

5 ante | panels

AN	NS
€ 4187,50	€ 4353,30

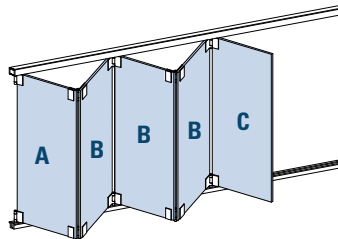

L-1000 SET 5

LB MAX = 6000 mm

6 ante | panels

AN	NS
€ 5278,30	€ 5500,70

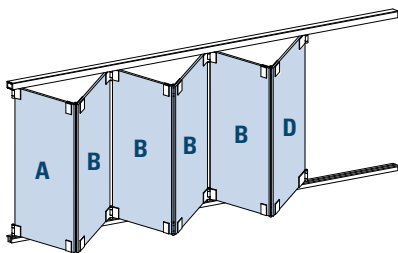

L-1000-ANTA F

LB MAX = 1000 mm

Porta laterale fissa
Fixed lateral pivoted door
Fest Drehflügel

AN	NS
€ 700,30	€ 720,30

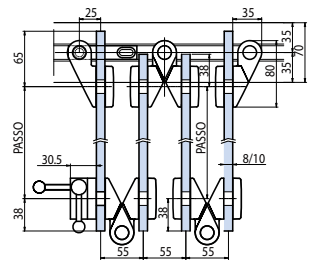
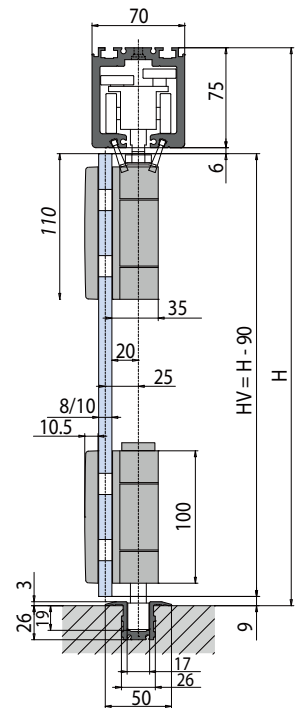
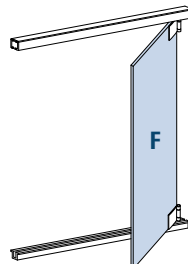

- Indicare sempre il verso di apertura, lo spessore del vetro e mandare il disegno fatto con [MY METALGLAS](#) al momento dell'ordine
- Please specify always opening direction, glass thickness and send technical drawing from [MY METALGLAS](#) when ordering
- Bitte immer Öffnungsrichtung, Glasdicke und technische Zeichnung von [MY METALGLAS](#) bei der Bestellung angeben

MIS













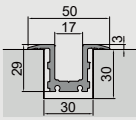



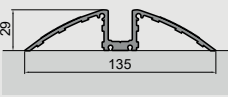



- Tagliato a misura del cliente
- Custom length
- Nach Mass geschnitten

> SET 5

- Prezzo su richiesta
- Price on request
- Preis auf Anfrage



- Trasporto fuori standard. Vedi condizioni di vendita
- Non-standard transport. See sales conditions
- Sondertransport. Siehe AGB

POS.	PROD.	ART.	MIS.	Q.TÀ	FIN.	EURO	FIN.	EURO
L-1000 OPTIONALS		▲ PARETI MOBILI 84/85						
PA-100 e L-113 inclusi nel set PA-100 and L-113 in set included PA-100 und im Set enthalten								
C.223		PA-100 FIX-3000	3000 mm	1 pc	AN	431,00/pc 143,67 /m		
		PA-100 FIX-6000 	6000 mm	1 pc	AN	861,50/pc 143,58 /m		
C.224		L-113 FIX-3000	3000 mm	1 pc	AN	114,00/pc 38,00 /m		
		L-113 FIX-6000 	6000 mm	1 pc	AN	227,30/pc 37,88 /m		
C.225		L-110 FIX-3000	3000 mm	1 pc	AN	71,50/pc 23,83 /m		
		L-110 FIX-6000 	6000 mm	1 pc	AN	142,50/pc 23,75 /m		
C.226		L-115 FIX-3000	3000 mm	1 pc	AN	212,10/pc 70,70 /m		
		L-115 FIX-6000 	6000 mm	1 pc	AN	424,20/pc 70,70 /m		
C.227		TAGLIO-PM • Costo per extra taglio misura binari • Extra cost track profiles cut to size • Aufpreis Laufschiene nach Mass geschnitten		1 pc		52,00/pc		
C.228		PA-113		1 pc	AN	51,00/pc		
C.229		WRU-M 80/50 MT5		 5 mt		77,50/pc 15,50 /m		
C.229.1		WRU-C-BUMP-MT12		 12 mt		247,30/pc 20,61 /m		
C.230								
C.231								
C.232		L-101		1 pc	AN	189,30/pc	NS	199,30/pc
C.233		L-102		1 pc	AN	296,30/pc	NS	306,70/pc
C.234		L-103		1 pc	AN	304,70/pc	NS	323,00/pc
C.235		L-104		1 pc	AN	369,70/pc	NS	387,50/pc
C.236		L-105		1 pc	AN	278,30/pc	NS	297,50/pc
C.237		L-106		1 pc	AN	327,30/pc	NS	345,30/pc
C.238		L-109		1 pc		28,70/pc		

PA-260

Scorrevoli a soffietto | Sliding centre folding | Falt-Schiebewandssysteme

► PARETI MOBILI 90/93

C.239

- Set compresi di binario, profili anta e pozzetti a terra
- Set with panel profiles, rail and floor sockets
- Set mit Flügelprofile, Laufschiene und Bodenbuchse

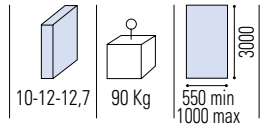

PA-260 SET 3	LB MAX = 2500 mm
3 ante panels	AN € 3390,30

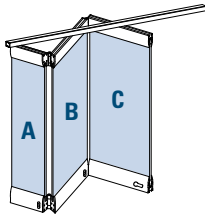

PA-260 SET 4	LB MAX = 4000 mm
4 ante panels	AN € 4856,50

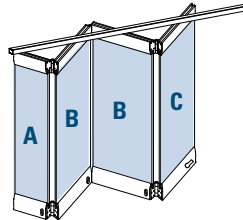

PA-260 SET 5	LB MAX = 5000 mm
5 ante panels	AN € 5846,70

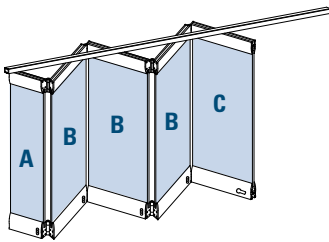

PA-260 SET 6	LB MAX = 6000 mm
6 ante panels	AN € 6827,00

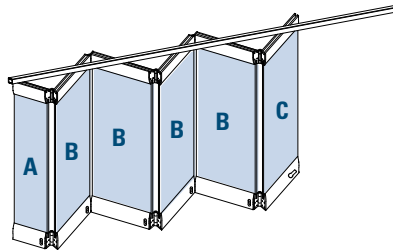

PA-260 SET 7	LB MAX = 6000 mm
7 ante panels	AN € 7813,00

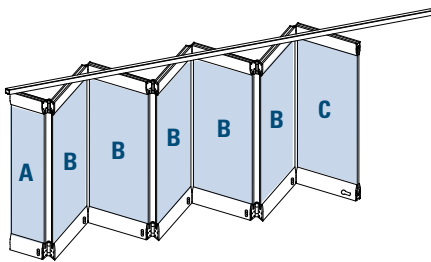

PA-260 SET 8	LB MAX = 6000 mm
8 ante panels	AN € 8799,00

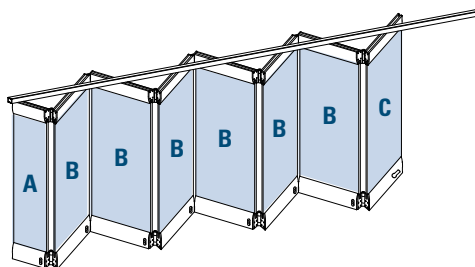

PA-200 ANTA D	LB MAX = 1200 mm
Porta laterale fissa Fixed lateral pivoted door Fest Drehflügel	AN € 854,50

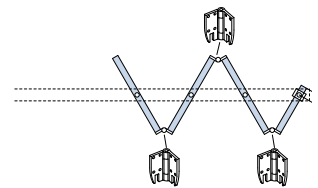
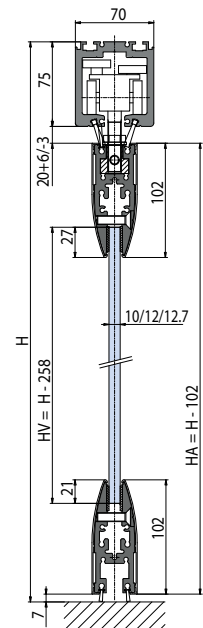
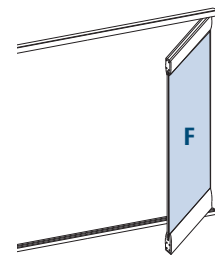

- Indicare sempre il verso di apertura, lo spessore del vetro e mandare il disegno fatto con **MY METALGLAS** al momento dell'ordine
- Please specify always opening direction, glass thickness and send technical drawing from **MY METALGLAS** when ordering
- Bitte immer Öffnungsrichtung, Glasdicke und technische Zeichnung von **MY METALGLAS** bei der Bestellung angeben

MIS













- Tagliato a misura del cliente
- Custom length
- Nach Mass geschnitten

> SET 8

- Prezzo su richiesta
- Price on request
- Preis auf Anfrage



- Trasporto fuori standard. Vedi condizioni di vendita
- Non-standard transport. See sales conditions
- Sondertransport. Siehe AGB

POS.	PROD.	ART.	MIS.	Q.TÀ	FIN.	EURO
PA-260 OPTIONALS		▲ PARETI MOBILI 90/93				
PA-100, L-112 a L-112-PA inclusi nel set PA-100, L-112 and L-112-PA in set included PA-100, L-112 und L-112-PA im Set enthalten						
C.240		PA-100 FIX-3000	3000 mm	1 pc	AN	431,00 /pc 143,67 /m
		PA-100 FIX-6000	 6000 mm	1 pc	AN	861,50 /pc 143,58 /m
C.241		TAGLIO-PM • Costo per extra taglio misura binari • Extra cost track profiles cut to size • Aufpreis Laufschiene nach Mass geschnitten		1 pc		52,00 /pc
C.242		L-112-PA • For panel C		1 pc	CS	34,70 /pc
C.243		L-112 • For panel A - B		1 pc	CS	34,70 /pc
C.244		PA-113		1 pc	AN	51,00 /pc
C.245		WRU-M 80/50 MT5		 5 mt		77,50 /pc 15,50 /m
C.245.1		WRU-C-BUMP-MT12		 12 mt		247,30 /pc 20,61 /m
C.246						
C.247						
C.248		PA-260 ANTA A		1 pc	AN	1003,30 /pc
C.249		PA-260 ANTA B		1 pc	AN	974,50 /pc
C.250		PA-260 ANTA C		1 pc	AN	765,00 /pc

PA-460
Scorrevoli a soffietto | Sliding centre folding | Falt-Schiebewandsysteme

► PARETI MOBILI 94/95

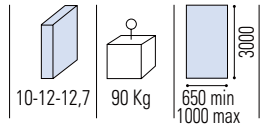

C.251

- Set compresi di binario, profili anta e pozzetti a terra
- Set with panel profiles, rail and floor sockets
- Set mit Flügelprofile, Laufschiene und Bodenbuchse

PA-460 SET 3	LB MAX = 2500 mm
3 ante panels	AN € 3072,70

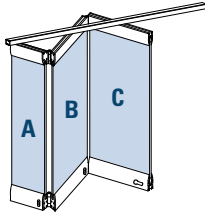

PA-460 SET 4	LB MAX = 4000 mm
4 ante panels	AN € 4385,30

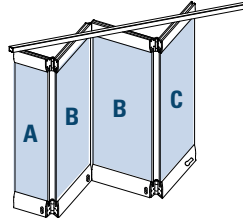

PA-460 SET 5	LB MAX = 5000 mm
5 ante panels	AN € 5268,00

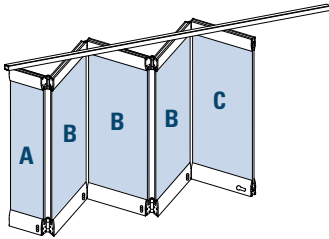

PA-460 SET 6	LB MAX = 6000 mm
6 ante panels	AN € 6150,50

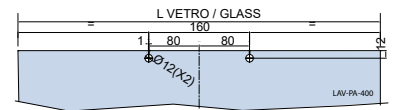
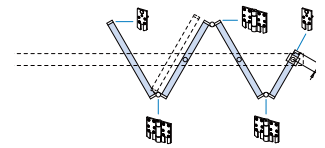
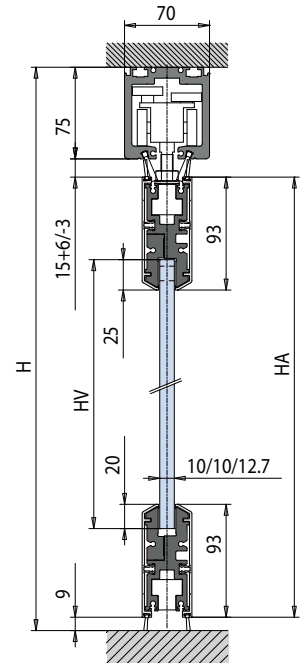
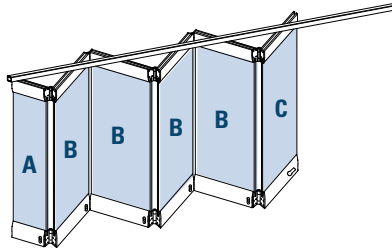

Lavorazione vetro | Glass preparation | Glasbearbeitung

PA-460 SET 7	LB MAX = 6000 mm
7 ante panels	AN € 7062,30

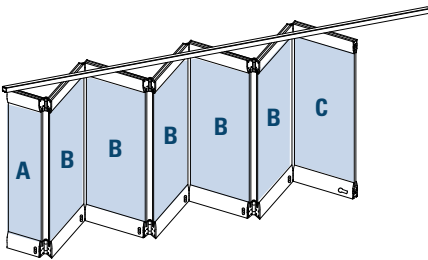

PA-460 SET 8	LB MAX = 6000 mm
8 ante panels	AN € 7921,70

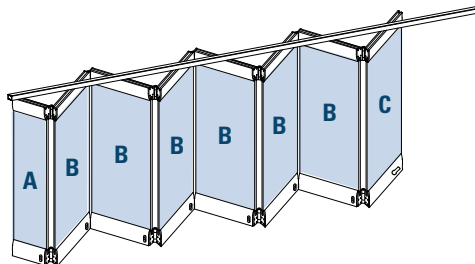

PA-400 ANTA D	L = 1200 mm
Porta laterale fissa Fixed lateral pivoted door Fest Drehflügel	AN € 915,30

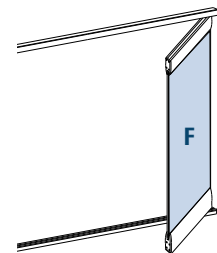

- Indicare sempre il verso di apertura, lo spessore del vetro e mandare il disegno fatto con **MY METALGLAS** al momento dell'ordine
- Please specify always opening direction, glass thickness and send technical drawing from **MY METALGLAS** when ordering
- Bitte immer Öffnungsrichtung, Glasdicke und technische Zeichnung von **MY METALGLAS** bei der Bestellung angeben

MIS

- Tagliato a misura del cliente
- Custom length
- Nach Mass geschnitten



- Tagliato dal cliente
- Cut by installer
- Schnitt bauseitig

> SET 8

- Prezzo su richiesta
- Price on request
- Preis auf Anfrage



- Trasporto fuori standard. Vedi condizioni di vendita
- Non-standard trasport. See sales conditions
- Sondertransport. Siehe AGB

POS.	PROD.	ART.	MIS.	Q.TÀ	FIN.	EURO
PA-460 OPTIONALS		▲ PARETI MOBILI 94/95				
PA-100 e L-112-PA inclusi nel set PA-100 and L-112-PA in set included PA-100 und L-112-PA im Set enthalten						
C.252		PA-100 FIX-3000	3000 mm	1 pc	AN	431,00 /pc 143,67 /m
		PA-100 FIX-6000	 6000 mm	1 pc	AN	861,50 /pc 143,58 /m
C.253		TAGLIO-PM • Costo per extra taglio misura binari • Extra cost track profiles cut to size • Aufpreis Laufschiene nach Mass geschnitten		1 pc		52,00 /pc
C.254		L-112-PA		1 pc	CS	34,70 /pc
C.255		PA-113		1 pc	AN	51,00 /pc
C.256		WRU-M 80/50 MT5		 5 mt		77,50 /pc 15,50 /m
C.256.1		WRU-C-BUMP-MT12		 12 mt		247,30 /pc 20,61 /m
C.257						
C.258						
C.259		PA-460 ANTA A  L = 1200 mm		1 pc	AN	822,30 /pc
C.260		PA-460 ANTA B  L = 1200 mm		1 pc	AN	872,70 /pc
C.261		PA-460 ANTA C  L = 1200 mm		1 pc	AN	769,70 /pc

do-it-yourself

- Profili anta forniti in misura FIX da tagliare cliente secondo schema [MY METALGLAS](#)
- Panel profiles supplied in FIX length cut by installer according to [MY METALGLAS](#) configurator
- Flügelprofile in Fixlängen schnitt bauseitig gemäss Konfigurator [MY METALGLAS](#)

PA-560
Scorrevoli a soffietto | Sliding centre folding | Falt-Schiebewandssysteme

► PARETI MOBILI 96/99

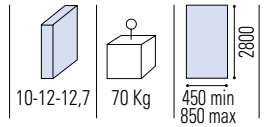

C.262

- Set compresi di binario, profili anta e pozzetti a terra
- Set with panel profiles, rail and floor sockets
- Set mit Flügelprofile, Laufschiene und Bodenbuchse

PA-560 SET 2	LB MAX = 2500 mm
3 ante panels	AN € 2743,70

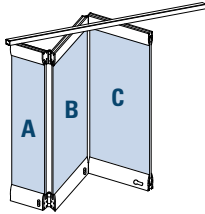

PA-560 SET 3	LB MAX = 4000 mm
4 ante panels	AN € 3949,70

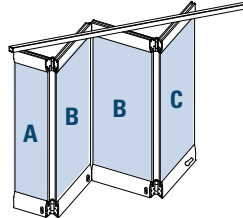

PA-560 SET 4	LB MAX = 5000 mm
5 ante panels	AN € 4656,00

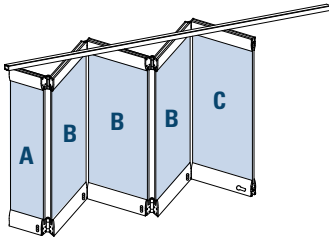

PA-560 SET 5	LB MAX = 6000 mm
6 ante panels	AN € 5457,30

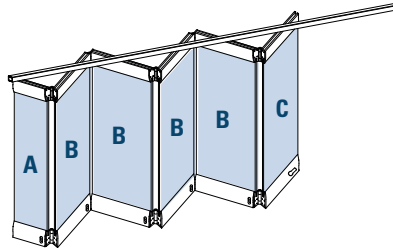

PA-560 SET 6	LB MAX = 6000 mm
7 ante panels	AN € 6259,70

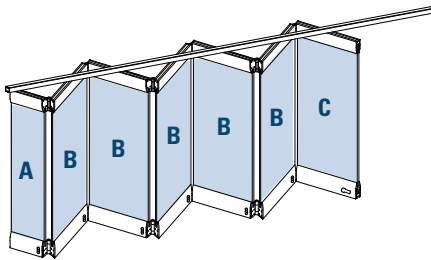

PA-560 SET 7	LB MAX = 6000 mm
8 ante panels	AN € 7056,30

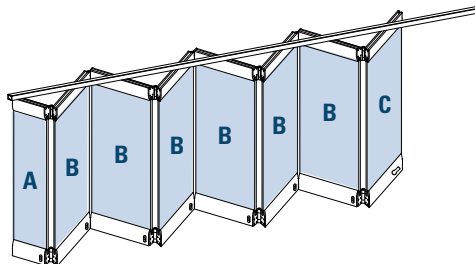

PA-560-ANTA F	L = 1000 mm
Porta laterale fissa Fixed lateral pivoted door Fest Drehflügel	AN € 815,00

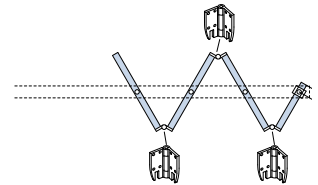
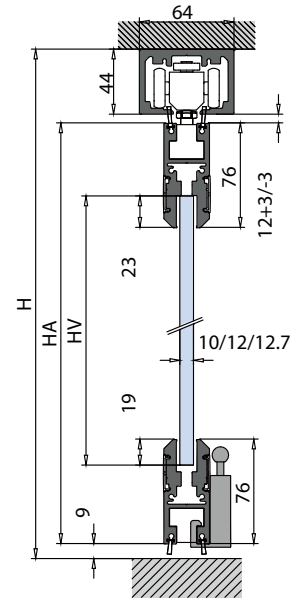
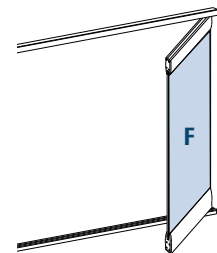

- Indicare sempre il verso di apertura, lo spessore del vetro e mandare il disegno fatto con **MY METALGLAS** al momento dell'ordine
- Please specify always opening direction, glass thickness and send technical drawing from **MY METALGLAS** when ordering
- Bitte immer Öffnungsrichtung, Glasdicke und technische Zeichnung von **MY METALGLAS** bei der Bestellung angeben

MIS

- Tagliato a misura del cliente
- Custom length
- Nach Mass geschnitten



- Tagliato dal cliente
- Cut by installer
- Schnitt bauseitig

> SET 7

- Prezzo su richiesta
- Price on request
- Preis auf Anfrage



- Trasporto fuori standard. Vedi condizioni di vendita
- Non-standard trasport. See sales conditions
- Sondertransport. Siehe AGB

POS.	PROD.	ART.	MIS.	Q.TÀ	FIN.	EURO
PA-560 OPTIONALS		▲ PARETI MOBILI 96/99				
L-150, PA-502 e BGF-10 inclusi nel set L-150, PA-502 and BGF-10 in set included L-150, PA-502 und BGF-10 im Set enthalten						
C.263		L-150 FIX-3000	3000 mm	1 pc	AN	314,30 /pc 104,77 /m
		L-150 FIX-6000	6000 mm	1 pc	AN	628,00 /pc 104,67 /m
C.264		TAGLIO-PM • Costo per extra taglio misura binari • Extra cost track profiles cut to size • Aufpreis Laufschiene nach Mass geschnitten		1 pc		52,00 /pc
C.265		WRU-M 80/50 MT5		5 mt		77,50 /pc 15,50 /m
C.265.1		WRU-C-BUMP-MT12		12 mt		247,30 /pc 20,61 /m
C.266						
C.267						
C.268		PA-560 ANTA A L = 1000 mm		1 pc	AN	778,70 /pc
C.269		PA-560 ANTA B L = 1000 mm		1 pc	AN	789,00 /pc
C.270		PA-560 ANTA C L = 1000 mm		1 pc	AN	696,30 /pc
C.271		PA-502		1 pc	AN	60,00 /pc
C.272		BGF-10		1 pc		6,30 /pc

do-it-yourself

- Profili anta forniti in misura FIX da tagliare cliente secondo schema [MY METALGLAS](#)
- Panel profiles supplied in FIX length cut by installer according to [MY METALGLAS](#) configurator
- Flügelprofile in Fixlängen schnitt bauseitig gemäss Konfigurator [MY METALGLAS](#)

L-2500

Scorrevoli a soffietto | Sliding centre folding | Falt-Schiebewandsysteme

► PARETI MOBILI 100/101

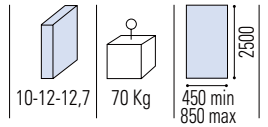

C.273

- Set ante, binario e pozzetti a terra inclusi
- Set panels with rail and floor sockets included
- Flügelset mit Laufschiene und Bodenbuchse enthalten

L-2500 SET 1

LB MAX = 2000 mm

2 ante | panels

AN € 1157,70

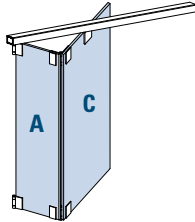

L-2500 SET 2

LB MAX = 2500 mm

3 ante | panels

AN € 1854,30

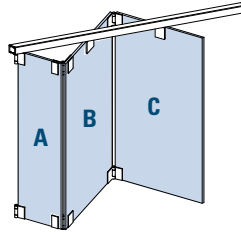

L-2500 SET 3

LB MAX = 4000 mm

4 ante | panels

AN € 2870,00

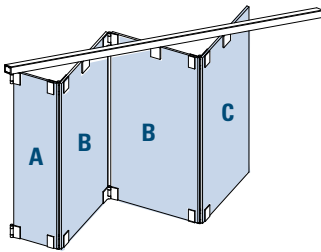

L-2500 SET 4

LB MAX = 5000 mm

5 ante | panels

AN € 3460,30

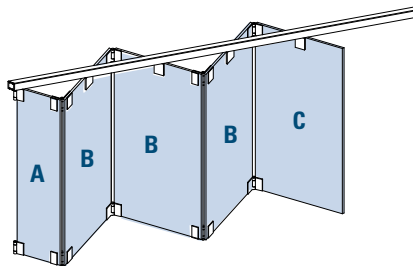

L-2500 SET 5

LB MAX = 6000 mm

6 ante | panels

AN € 4217,00

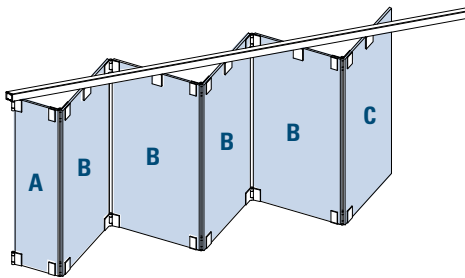

L-2500-ANTA F

LB MAX = 850 mm

Porta laterale fissa
Fixed lateral pivoted door
Fest Drehflügel

AN € 518,50

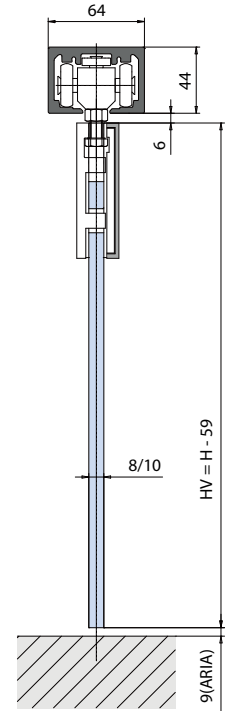
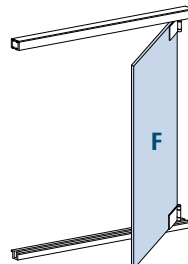

- Indicare sempre il verso di apertura, lo spessore del vetro e mandare il disegno fatto con [MY METALGLAS](#) al momento dell'ordine
- Please specify always opening direction, glass thickness and send technical drawing from [MY METALGLAS](#) when ordering
- Bitte immer Öffnungsrichtung, Glasdicke und technische Zeichnung von [MY METALGLAS](#) bei der Bestellung angeben

MIS

- Tagliato a misura del cliente
- Custom length
- Nach Mass geschnitten

> SET 5

- Prezzo su richiesta
- Price on request
- Preis auf Anfrage



- Trasporto fuori standard. Vedi condizioni di vendita
- Non-standard transport. See sales conditions
- Sondertransport. Siehe AGB

POS.	PROD.	ART.	MIS.	Q.TÀ	FIN.	EURO
L-2500 OPTIONALS		▲ PARETI MOBILI 86/87				
L-150 e L-112 inclusi nel set L-150 and L-112 in set included L-150 und L-112 im Set enthalten						
C.274		L-150 FIX-3000	3000 mm	1 pc	AN	314,30 /pc 104,77 /m
		L-150 FIX-6000	 6000 mm	1 pc	AN	628,00 /pc 104,67 /m
C.275		TAGLIO-PM • Costo per extra taglio misura binari • Extra cost track profiles cut to size • Aufpreis Laufschiene nach Mass geschnitten		1 pc		52,00 /pc
C.276		L-112		1 pc	CS	34,70 /pc
C.277		WRU-M 80/50 MT5		 5 mt		77,50 /pc 15,50 /m
C.277.1		WRU-C-BUMP-MT12		 12 mt		247,30 /pc 20,61 /m
C.278						
C.279						
C.280		L-205		1 pc	AN	186,30 /pc
C.281		L-206		1 pc	AN	210,50 /pc
C.282		L-213		1 pc	AN	174,00 /pc
C.283		L-214		1 pc	AN	400,70 /pc

BALCONGLAS FALCINO-50

► PARETI MOBILI 104/107

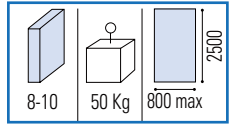

C.305

- Sistema con canalina
- System with bottom guide
- System mit Bodenführung

FALCINO SET 2

LB = 1600 mm

2 ante | panels

AN	RAL 9010
€ 1593,50	€ 1606,50

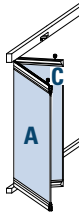

FALCINO SET 3

LB = 2400 mm

3 ante | panels

AN	RAL 9010
€ 2105,30	€ 2118,70

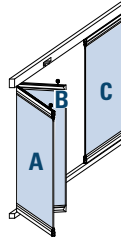

FALCINO SET 4

LB = 3200 mm

4 ante | panels

AN	RAL 9010
€ 2521,00	€ 2550,30

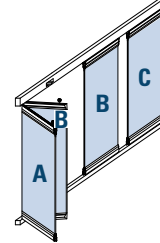

FALCINO SET 5

LB = 4000 mm

5 ante | panels

AN	RAL 9010
€ 2999,30	€ 3031,30

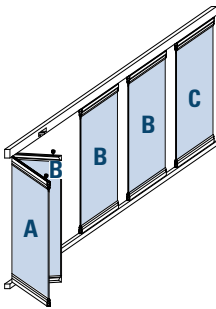

FALCINO SET 6

LB = 4800 mm

6 ante | panels

AN	RAL 9010
€ 3478,70	€ 3510,50

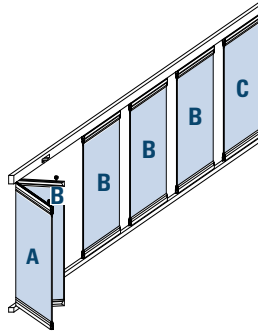

FALCINO SET 7

LB = 5600 mm

7 ante | panels

AN	RAL 9010
€ 4032,30	€ 4083,70

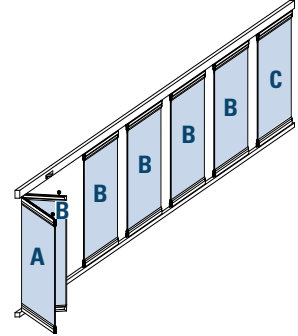

FALCINO SET 8

LB = 6400 mm

8 ante | panels

AN	RAL 9010
€ 4314,30	€ 4358,00

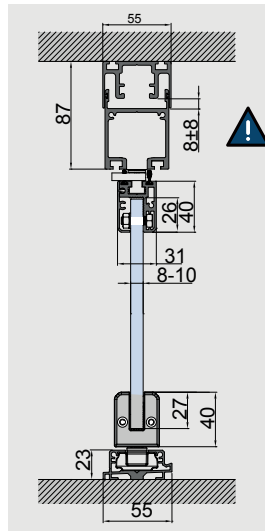
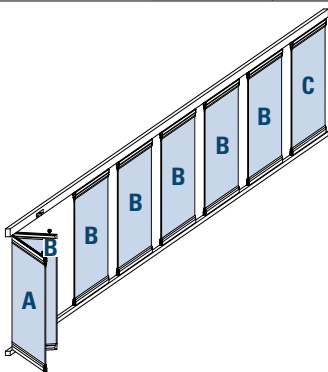

- Indicare sempre il verso di apertura e mandare il disegno fatto con **MY METALGLAS** al momento dell'ordine
- Please specify always opening direction and send technical drawing from **MY METALGLAS** when ordering
- Bitte immer Öffnungsrichtung und technische Zeichnung von **MY METALGLAS** bei der Bestellung angeben

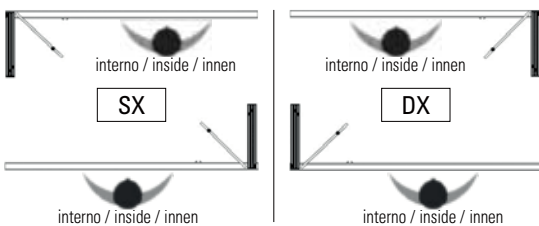

OPTIONAL	COD.	FIN	PRICE
	V-565	CP	€ 143,30
	V-569-2FLG	CP	€ 143,30
	C-010	CR	€ 28,00
	WRU-M 80/50 MT5 5 mt		€ 77,50 € 15,50 / m
	BGM-MON L = 3000 mm	AN	€ 206,70 /set
	BGM-110 • Canalina incassata • Recessed floor profile • Versenkte Bodenschiene	AN	€ 55,30 /m extra/ aufpreis

- Tagliato dal cliente
- Cut by installer
- Schnitt bauseitig

extra uscita / extra exit / extra ausfahrt € 50,00

Prezzo per misura anta minima 700 mm (set 3-4-5) e 800 mm (set 6) con una maschera di uscita. Per ante < 700 mm (set 3-4-5) e < 800 mm (set 6) prezzo su richiesta.
Price for panel's width min. 700 mm (set 3-4-5) and 800 mm (set 6) with one exit. For panels with < 700 mm (set 3-4-5) and < 800 mm (set 6) prices on request.
Preis für Flügelbreite min. 700 mm (set 3-4-5) und 800 mm (set 6) mit einer Ausfahrt. Flügelbreite < 700 mm (set 3-4-5) und < 800 mm (set 6) Preis auf Anfrage.

> SET 8

- Prezzo su richiesta
- Price on request
- Preis auf Anfrage



- Trasporto fuori standard. Vedi condizioni di vendita
- Non-standard transport. See sales conditions
- Sondertransport. Siehe AGB

BALCONGLAS FALCINO PARK-50

► PARETI MOBILI 108/111

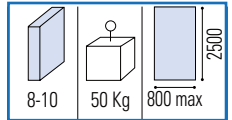

C.306

- Sistema senza canalina
- System without bottom guide
- System ohne Bodenführung

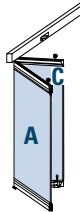
FALCINO PARK 2	LB = 1600 mm	
	AN	RAL 9010
2 ante panels	€ 1697,30	€ 1710,00

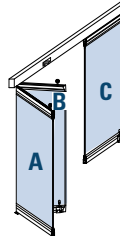

FALCINO PARK 3	LB = 2400 mm	
	AN	RAL 9010
3 ante panels	€ 2300,00	€ 2313,70



FALCINO PARK 4	LB = 3200 mm	
	AN	RAL 9010
4 ante panels	€ 2819,30	€ 2848,00

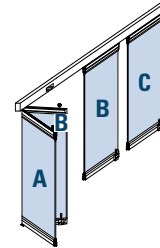

FALCINO PARK 5	LB = 4000 mm	
	AN	RAL 9010
5 ante panels	€ 3389,00	€ 3421,30

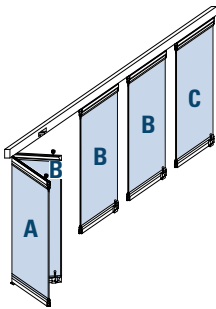

FALCINO PARK 6	LB = 4800 mm	
	AN	RAL 9010
6 ante panels	€ 3971,30	€ 4004,70

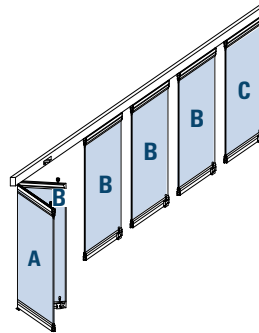

FALCINO PARK 7	LB = 5600 mm	
	AN	RAL 9010
7 ante panels	€ 4580,30	€ 4631,70

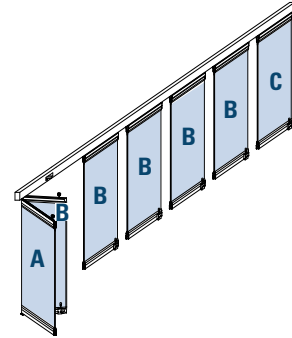

FALCINO PARK 8	LB = 6400 mm	
	AN	RAL 9010
8 ante panels	€ 5002,00	€ 5053,30

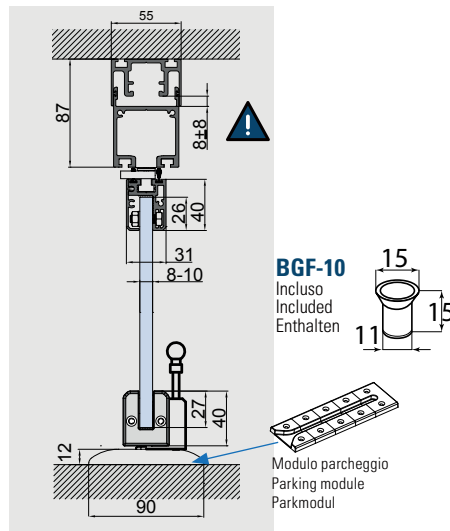
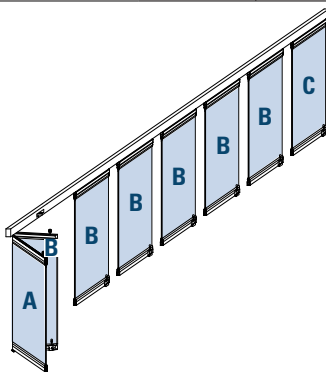

- Indicare sempre il verso di apertura e mandare il disegno fatto con **MY METALGLAS** al momento dell'ordine
- Please specify always opening direction and send technical drawing from **MY METALGLAS** when ordering
- Bitte immer Öffnungsrichtung und technische Zeichnung von **MY METALGLAS** bei der Bestellung angeben

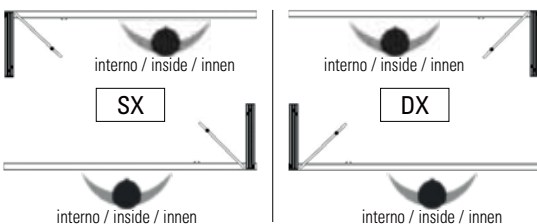

OPTIONAL	COD.	FIN	PRICE
	V-565	CP	€ 143,30
	V-569-2FLG	CP	€ 143,30
	C-010	CR	€ 28,00
	WRU-M 80/50 MT5 5 mt		€ 77,50 € 15,50 / m
	BGM-MON L = 3000 mm	AN	€ 206,70 /set
	L-112-PA • Pozzetto eccentrico • Eccentric floor socket • Exzenterbuchse verstellbar	CS	€ 34,70

do-it-yourself

- Binario superiore da tagliare cliente dalla parte opposta alla fresatura. Profili anta, canalina e profilo regolatore forniti in misura FIX da tagliare cliente secondo schema **MY METALGLAS**
- Top track profile cut by installer on the opposite side of the opening. Panel profiles, floor profile and wall profile for adjustment supplied in FIX length cut by installer according to **MY METALGLAS** configurator
- Laufschieneprofil Schnitt bauseitig auf der anderen Seite der Öffnung. Flügelprofile, Bodenschiene und Wandprofil für Verstellung in Fixlängen schnitt bauseitig gemäss Konfigurator **MY METALGLAS**

POS.	PROD.	ART.	MIS.	Q.TÀ	FIN.	EURO	FIN.	EURO
BALCONGLAS FALCINO-50 FALCINO PARK-50						▲ PARETI MOBILI 104/111		
<i>COMPONENTI / COMPONENTS / EINZELTEILE</i>								
C.307		BGM-100/101	1600 mm	1 pc	AN	360,30 /pc	RAL 9010	366,30 /pc
			2400 mm	1 pc	AN	478,50 /pc	RAL 9010	487,70 /pc
			3200 mm	1 pc	AN	579,30 /pc	RAL 9010	592,00 /pc
			4000 mm	1 pc	AN	681,30 /pc	RAL 9010	695,30 /pc
			4800 mm	1 pc	AN	800,30 /pc	RAL 9010	816,70 /pc
			5600 mm	1 pc	AN	963,30 /pc	RAL 9010	983,00 /pc
			6400 mm	1 pc	AN	978,30 /pc	RAL 9010	1000,00 /pc
C.308		BGM-102	1600 mm	1 pc	AN	188,30 /pc	RAL 9010	190,50 /pc
			2400 mm	1 pc	AN	231,00 /pc	RAL 9010	234,30 /pc
			3200 mm	1 pc	AN	260,50 /pc	RAL 9010	265,00 /pc
			4000 mm	1 pc	AN	297,50 /pc	RAL 9010	302,00 /pc
			4800 mm	1 pc	AN	339,70 /pc	RAL 9010	345,70 /pc
			5600 mm	1 pc	AN	375,30 /pc	RAL 9010	383,50 /pc
			6400 mm	1 pc	AN	388,00 /pc	RAL 9010	395,70 /pc
C.309		BGM-103	1600 mm	1 pc	AN	112,70 /pc	RAL 9010	114,00 /pc
			2400 mm	1 pc	AN	146,00 /pc	RAL 9010	148,30 /pc
			3200 mm	1 pc	AN	171,00 /pc	RAL 9010	174,70 /pc
			4000 mm	1 pc	AN	197,50 /pc	RAL 9010	201,00 /pc
			4800 mm	1 pc	AN	231,00 /pc	RAL 9010	235,50 /pc
			5600 mm	1 pc	AN	274,30 /pc	RAL 9010	280,30 /pc
			6400 mm	1 pc	AN	270,00 /pc	RAL 9010	276,70 /pc
C.310		BGM-110	2000 mm	1 pc	AN	118,50 /pc	RAL 9010	119,50 /pc
			3000 mm	1 pc	AN	152,70 /pc	RAL 9010	155,30 /pc
			4000 mm	1 pc	AN	221,70 /pc	RAL 9010	225,30 /pc
			6000 mm	1 pc	AN	249,30 /pc	RAL 9010	255,00 /pc
C.311		TAGLIO-BGM	<ul style="list-style-type: none"> • Costo per extra taglio misura profili • Extra cost profiles cut to size • Aufpreis Profile nach Mass geschnitten 	1 pc		48,30 /pc		
C.312		LAV-BGM-100 SX-EXT SX-INT LAV-BGM-110 DX-EXT DX-INT	<ul style="list-style-type: none"> • Lavorazione profilo BGM-100, fresatura per uscita ante • Profile BGM-100 preparation, milling for panel exit • Profilbearbeitung BGM-100, Fräsung für Ausfahrt der Flügel 	1 pc		57,70 /pc		
C.313		BGM-113	<ul style="list-style-type: none"> • Pezzo profilo per apertura manutenzione • Profil piece for maintenance • Revisionsstück 	1 pc	AN	54,30 /pc	RAL 9010 54,30 /pc	
C.314		BGF-18	<ul style="list-style-type: none"> • Set 2 pz piastine di giunzione • Set 2 pc connecting plates • Set 2 Stk Verbindungsplatten 	2 pcs		33,50 /set		
C.315		BG-13	<ul style="list-style-type: none"> • Pinza doppia ferma pannelli • Fixation pin kit • Doppel klemme Flügel stopper 	1 pc		74,20 /pc		

- Tagliato dal cliente
- Cut by installer
- Schnitt bauseitig
- Trasporto fuori standard. Vedi condizioni di vendita
- Non-standard transport. See sales conditions
- Sondertransport. Siehe AGB

BALCONGLAS FALCINO-50
 COMPONENTI / COMPONENTS / EINZELTEILE

BALCONGLAS FALCINO PARK-50
 COMPONENTI / COMPONENTS / EINZELTEILE

BGM-ANTA A DX € 329,30
BGM-ANTA A SX
BGM-ANTA B DX € 274,30
BGM-ANTA B SX
BGM-ANTA C DX € 274,30
BGM-ANTA C SX
BGM-PARK ANTA A DX € 329,30
BGM-PARK ANTA A SX
BGM-PARK ANTA B DX € 366,30
BGM-PARK ANTA B SX
BGM-PARK ANTA C DX € 366,30
BGM-PARK ANTA C SX
BGM-01 DX € 46,30
BGM-01 SX

NEW RESTYLING 2019

BGM-02 DX € 59,00
BGM-02 SX

NEW RESTYLING 2019

BGM-03 € 20,00

BGM-04 € 21,00

BGM-05 € 56,50

BGM-06 DX € 17,30
BGM-06 SX

BGM-07 € 33,50

BGM-08 € 20,00

BGM-09 € 11,70

BGM-10 € 11,70

BGM-11 € 10,70

BGM-12 € 10,70

BGM-14 € 21,00

BGM-15 € 17,30

BGM-17 € 6,30/m

BGM-19 € 17,30

BGM-13 € 92,00

BGM-20E € 11,70

BGM-20P € 11,70

BGM-20S € 11,70

do-it-yourself

- Binario superiore da tagliare cliente dalla parte opposta alla fresatura. Profili anta, canalina e profilo regolatore forniti in misura FIX da tagliare cliente secondo schema [MY METALGLAS](#)
- Top track profile cut by installer on the opposite side of the opening. Panel profiles, floor profile and wall profile for adjustment supplied in FIX length cut by installer according to [MY METALGLAS](#) configurator
- Laufschieneprofil Schnitt bauseitig auf der anderen Seite der Öffnung. Flügelprofile, Bodenschiene und Wandprofil für Verstellung in Fixlängen schnitt bauseitig gemäss Konfigurator [MY METALGLAS](#)

BALCONGLAS FALCE-70

► PARETI MOBILI 112/115

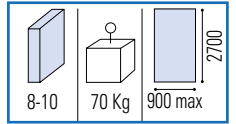

- C.316**
- Sistema con canalina
 - System with bottom guide
 - System mit Bodenführung

BGF-SET 2 LB = 2000 mm

AN

2 ante | panels

€ 2444,50

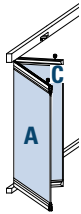

BGF-SET 3 LB = 3000 mm

AN

3 ante | panels

€ 3594,50

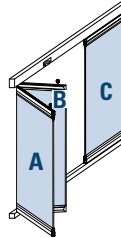

BGF-SET 4 LB = 4000 mm

AN

4 ante | panels

€ 5089,30

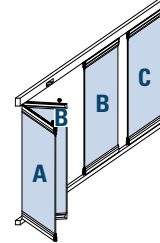

BGF-SET 5 LB = 5000 mm

AN

5 ante | panels

€ 6070,30

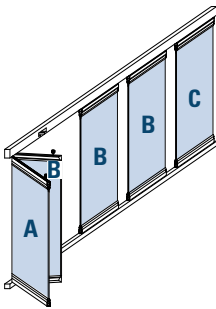

BGF-SET 6 LB = 6000 mm

AN

6 ante | panels

€ 7098,00

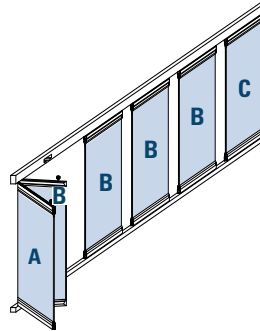

BGF-SET 7 LB = 6000 mm

AN

7 ante | panels

€ 7967,50

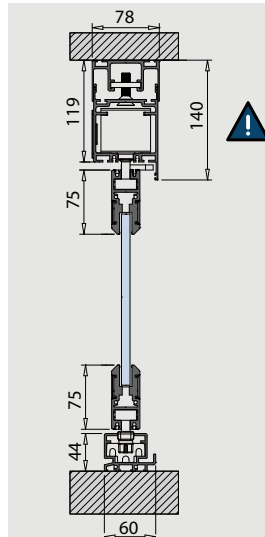
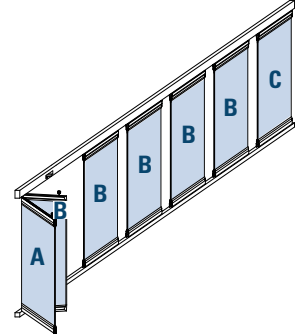

- Indicare sempre il verso di apertura, lo spessore del vetro e mandare il disegno fatto con **MY METALGLAS** al momento dell'ordine
- Please specify always opening direction, glass thickness and send technical drawing from **MY METALGLAS** when ordering
- Bitte immer Öffnungsrichtung, Glasdicke und technische Zeichnung von **MY METALGLAS** bei der Bestellung angeben

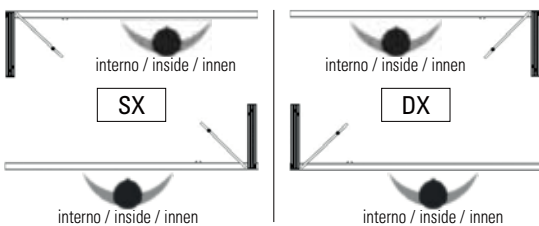

OPTIONAL	COD.	FIN	PRICE
	V-565	CP	€ 143,30
	V-569-2FLG	CP	€ 143,30
	C-010	CR	€ 28,00
	WRU-M 80/50 MT5 5 mt		€ 77,50 € 15,50 / m
	BG-110 INC • Canalina incassata • Recessed floor profile • Versenkte Bodenschiene	AN	€ 55,30 / m extra/ aufpreis
	BG-13 • Pinza doppia ferma pannelli • Fixation pin kit • Doppel klemme Flügel stopper		€ 74,20

- Tagliato dal cliente
- Cut by installer
- Schnitt bauseitig

extra uscita / extra exit / extra ausfahrt € 50,00
 Prezzo per misura anta minima 700 mm (set 3-4-5) e 800 mm (set 6) con una maschera di uscita. Per ante < 700 mm (set 3-4-5) e < 800 mm (set 6) prezzo su richiesta.
 Price for panel's width min. 700 mm (set 3-4-5) and 800 mm (set 6) with one exit. For panels with < 700 mm (set 3-4-5) and < 800 mm (set 6) prices on request.
 Preis für Flügelbreite min. 700 mm (set 3-4-5) und 800 mm (set 6) mit einer Ausfahrt. Flügelbreite < 700 mm (set 3-4-5) und < 800 mm (set 6) Preis auf Anfrage.

- > SET 7**
- Prezzo su richiesta
 - Price on request
 - Preis auf Anfrage

-
- Trasporto fuori standard. Vedi condizioni di vendita
 - Non-standard transport. See sales conditions
 - Sondertransport. Siehe AGB

BALCONGLAS FALCE PARK-70

► PARETI MOBILI 116/119

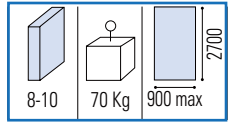
C.317

- Sistema senza canalina
- System without bottom guide
- System ohne Bodenführung

BGF-PARK 2

LB = 2000 mm

AN

2 ante | panels

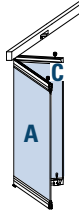
€ 2631,30

BGF-PARK 3

LB = 3000 mm

AN

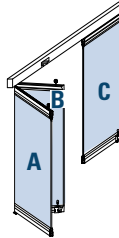
3 ante | panels

€ 3774,50

BGF-PARK 4

LB = 4000 mm

AN

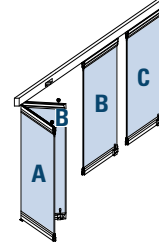
4 ante | panels

€ 5397,70

BGF-PARK 5

LB = 5000 mm

AN

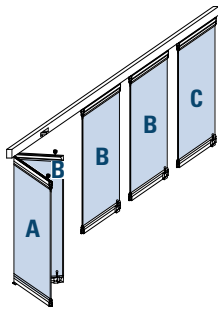
5 ante | panels

€ 6545,00

BGF-PARK 6

LB = 6000 mm

AN

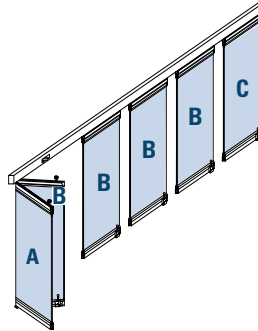
6 ante | panels

€ 7750,00

BGF-PARK 7

LB = 6000 mm

AN

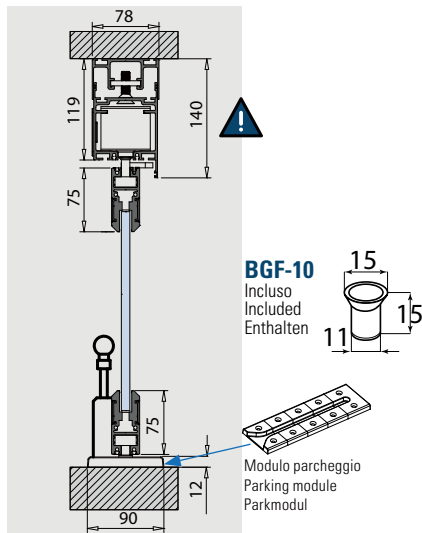
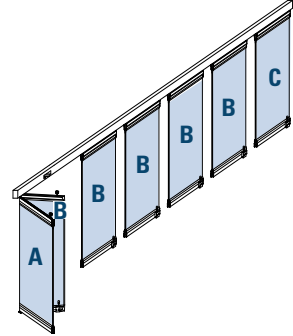
7 ante | panels

€ 8764,50

- Indicare sempre il verso di apertura, lo spessore del vetro e mandare il disegno fatto con **MY METALGLAS** al momento dell'ordine
- Please specify always opening direction, glass thickness and send technical drawing from **MY METALGLAS** when ordering
- Bitte immer Öffnungsrichtung, Glasdicke und technische Zeichnung von **MY METALGLAS** bei der Bestellung angeben

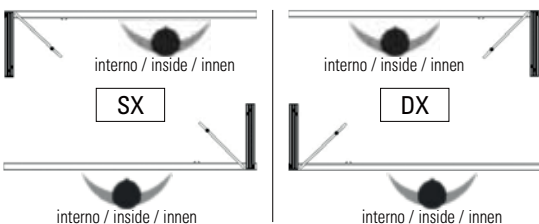

OPTIONAL	COD.	FIN	PRICE
	V-565	CP	€ 143,30
	V-569-2FLG	CP	€ 143,30
	C-010	CR	€ 28,00
	WRU-M 80/50 MT5 5 mt		€ 77,50 € 15,50 / m
	L-112-PA • Pozzetto eccentrico • Eccentric floor socket • Exzenterbuchse verstellbar	CS	€ 34,70
	BG-13 • Pinza doppia ferma pannelli • Fixation pin kit • Doppel klemme Flügel stopper		€ 74,20

do-it-yourself

- Binario superiore da tagliare cliente dalla parte opposta alla fresatura. Profili anta, canalina e profilo regolatore forniti in misura FIX da tagliare cliente secondo schema **MY METALGLAS**
- Top track profile cut by installer on the opposite side of the opening. Panel profiles, floor profile and wall profile for adjustment supplied in FIX length cut by installer according to **MY METALGLAS** configurator
- Laufschienenprofil Schnitt bauseitig auf der anderen Seite der Öffnung. Flügelprofile, Bodenschiene und Wandprofil für Verstellung in Fixlängen schnitt bauseitig gemäss Konfigurator **MY METALGLAS**

BALCONGLAS FALCE-70B

► PARETI MOBILI 120

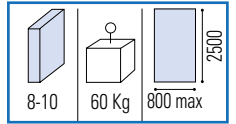

C.318

- Sistema con canalina
- System with bottom guide
- System mit Bodenführung

BGF-B-SET 2

LB = 2000 mm

AN

2 ante | panels

€ 2081,00

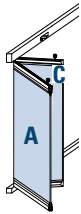

BGF-B-SET 3

LB = 3000 mm

AN

3 ante | panels

€ 3048,70

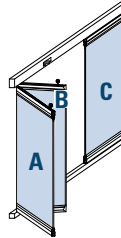

BGF-B-SET 4

LB = 4000 mm

AN

4 ante | panels

€ 4362,30

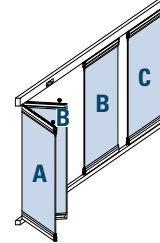

BGF-B-SET 5

LB = 5000 mm

AN

5 ante | panels

€ 5161,50

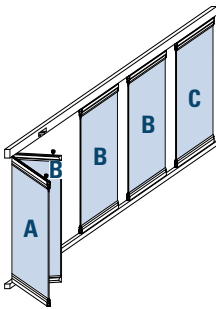

BGF-B-SET 6

LB = 6000 mm

AN

6 ante | panels

€ 6008,70

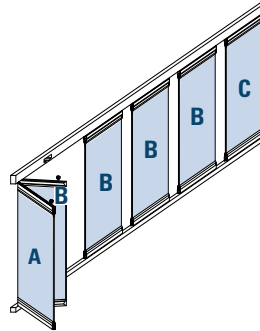

BGF-B-SET 7

LB = 6000 mm

AN

7 ante | panels

€ 6684,30

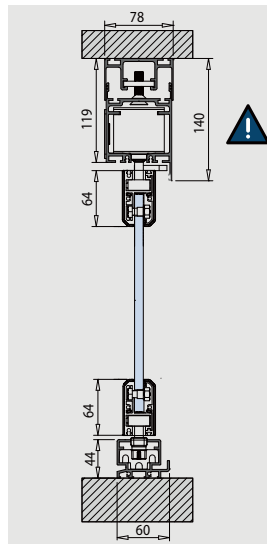
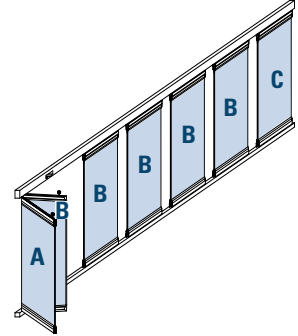

- Indicare sempre il verso di apertura e mandare il disegno fatto con **MY METALGLAS** al momento dell'ordine
- Please specify always opening direction and send technical drawing from **MY METALGLAS** when ordering
- Bitte immer Öffnungsrichtung und technische Zeichnung von **MY METALGLAS** bei der Bestellung angeben

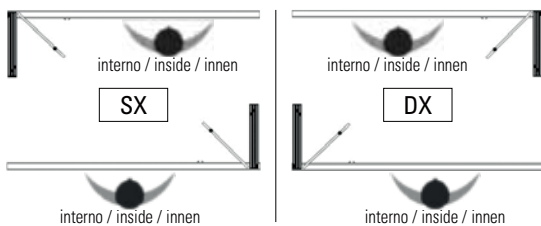

OPTIONAL	COD.	FIN	PRICE
	V-565	CP	€ 143,30
	V-569-2FLG	CP	€ 143,30
	C-010	CR	€ 28,00
	WRU-M 80/50 MT5 5 mt		€ 77,50 € 15,50 / m
	BG-110 INC • Canalina incassata • Recessed floor profile • Versenkte Bodenschiene	AN	€ 55,30 / m extra/ aufpreis
	BG-13 • Pinza doppia ferma pannelli • Fixation pin kit • Doppel klemme Flügel stopper		€ 74,20

- Tagliato dal cliente
- Cut by installer
- Schnitt bauseitig

extra uscita / extra exit / extra ausfahrt € 50,00

Prezzo per misura anta minima 700 mm (set 3-4-5) e 800 mm (set 6) con una maschera di uscita. Per ante < 700 mm (set 3-4-5) e < 800 mm (set 6) prezzo su richiesta.
Price for panel's width min. 700 mm (set 3-4-5) and 800 mm (set 6) with one exit. For panels with < 700 mm (set 3-4-5) and < 800 mm (set 6) prices on request.
Preis für Flügelbreite min. 700 mm (set 3-4-5) und 800 mm (set 6) mit einer Ausfahrt. Flügelbreite < 700 mm (set 3-4-5) und < 800 mm (set 6) Preis auf Anfrage.

> SET 7

- Prezzo su richiesta
- Price on request
- Preis auf Anfrage



- Trasporto fuori standard. Vedi condizioni di vendita
- Non-standard transport. See sales conditions
- Sondertransport. Siehe AGB

BALCONGLAS FALCE PARK-70B

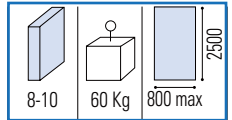
► PARETI MOBILI 121

C.319

- Sistema senza canalina
- System without bottom guide
- System ohne Bodenführung

BGF-B-PARK SET 2

LB = 2000 mm

AN

2 ante | panels

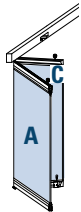
€ 2186,50

BGF-B-PARK SET 3

LB = 3000 mm

AN

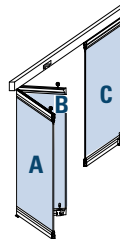
3 ante | panels

€ 3197,50

BGF-B-PARK SET 4

LB = 4000 mm

AN

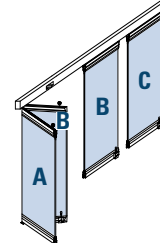
4 ante | panels

€ 4565,30

BGF-B-PARK SET 5

LB = 5000 mm

AN

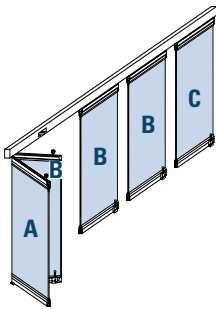
5 ante | panels

€ 5404,30

BGF-B-PARK SET 6

LB = 6000 mm

AN

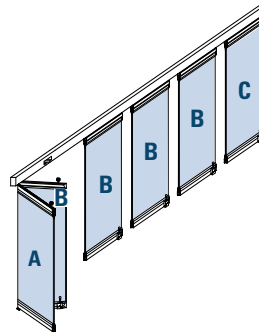
6 ante | panels

€ 6295,50

BGF-B-PARK SET 7

LB = 6000 mm

AN

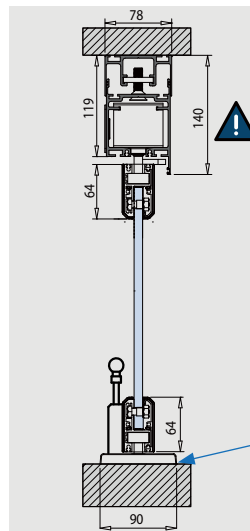
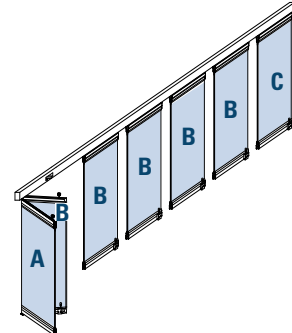
7 ante | panels

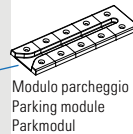
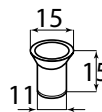
€ 7006,00

BGF-10

 Incluso
Included
Enthalten

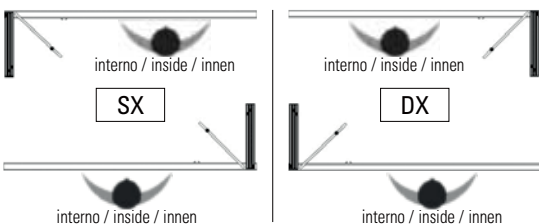
- Indicare sempre il verso di apertura e mandare il disegno fatto con **MY METALGLAS** al momento dell'ordine
- Please specify always opening direction and send technical drawing from **MY METALGLAS** when ordering
- Bitte immer Öffnungsrichtung und technische Zeichnung von **MY METALGLAS** bei der Bestellung angeben



OPTIONAL	COD.	FIN	PRICE
	V-565	CP	€ 143,30
	V-569-2FLG	CP	€ 143,30
	C-010	CR	€ 28,00
	WRU-M 80/50 MT5 5 mt		€ [PAY] € 15,50 / m
	L-112-PA • Pozzetto eccentrico • Eccentric floor socket • Exzenterbuchse verstellbar	CS	€ 34,70
	BG-13 • Pinza doppia ferma pannelli • Fixation pin kit • Doppel klemme Flügel stopper		€ 74,20

do-it-yourself

- Binario superiore da tagliare cliente dalla parte opposta alla fresatura. Profili anta, canalina e profilo regolatore forniti in misura FIX da tagliare cliente secondo schema **MY METALGLAS**
- Top track profile cut by installer on the opposite side of the opening. Panel profiles, floor profile and wall profile for adjustment supplied in FIX length cut by installer according to **MY METALGLAS** configurator
- Laufschieneprofil Schnitt bauseitig auf der anderen Seite der Öffnung. Flügelprofile, Bodenschiene und Wandprofil für Verstellung in Fixlängen schnitt bauseitig gemäss Konfigurator **MY METALGLAS**

BALCONGLAS FALCE-ISO

► PARETI MOBILI 122/125

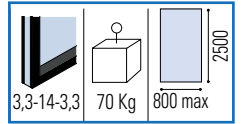

C.320

- Sistema con canalina. Maniglia e cilindro inclusi
- System with bottom guide. Handle and cylinder included
- System mit Bodenführung. Türgriffe und Zylinder enthalten

BG-ISO SET 2

LB = 2000 mm

AN

2 ante | panels

€ 3211,50

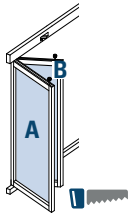

BG-ISO SET 3

LB = 3000 mm

AN

3 ante | panels

€ 4591,70

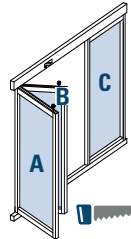

BG-ISO SET 4

LB = 4000 mm

AN

4 ante | panels

€ 6321,50

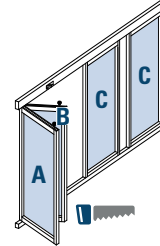

BG-ISO SET 5

LB = 5000 mm

AN

5 ante | panels

€ 7533,50

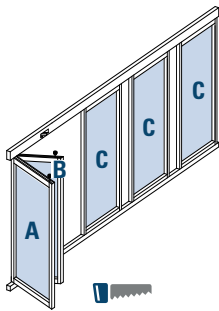

BG-ISO SET 6

LB = 6000 mm

AN

6 ante | panels

€ 8810,30

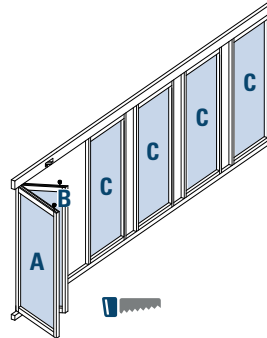

BG-ISO SET 7

LB = 6000 mm

AN

7 ante | panels

€ 9925,00

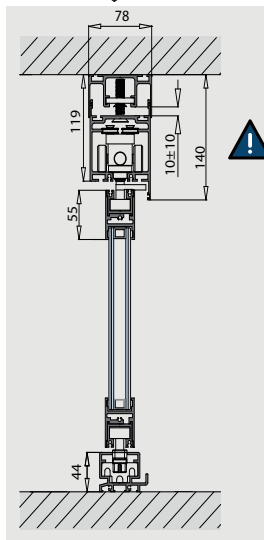
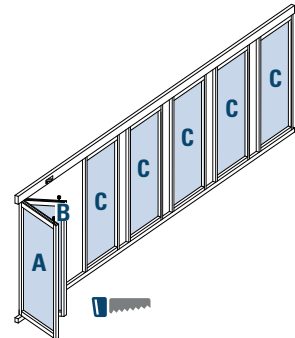

- Indicare sempre il verso di apertura e mandare il disegno fatto con **MY METALGLAS** al momento dell'ordine
- Please specify always opening direction and send technical drawing from **MY METALGLAS** when ordering
- Bitte immer Öffnungsrichtung und technische Zeichnung von **MY METALGLAS** bei der Bestellung angeben

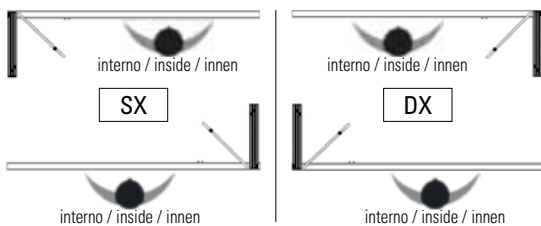

OPTIONAL	COD.	FIN	PRICE
	BGF-ISO-U	AN	€ 137,30
	• Montante lato anta "U" • "U" side profile • "U" seitliches Profil		
	BGF-ISO-L	AN	€ 107,50
	• Montante lato porta "L" • "L" side profile • "L" seitliches Profil		
	BG-110 INC	AN	€ 55,30 / m extra/aufpreis
	• Canalina incassata • Recessed floor profile • Versenkte Bodenschiene		
	BG-13		€ 74,20
	• Pinza doppia ferma pannelli • Fixation pin kit • Doppel klemme Flügel stopper		

- Tagliato dal cliente
- Cut by installer
- Schnitt bauseitig

extra uscita / extra exit / extra ausfahrt € 50,00

Prezzo per misura anta minima 700 mm (set 3-4-5) e 800 mm (set 6) con una maschera di uscita. Per ante < 700 mm (set 3-4-5) e < 800 mm (set 6) prezzo su richiesta.
Price for panel's width min. 700 mm (set 3-4-5) and 800 mm (set 6) with one exit. For panels with < 700 mm (set 3-4-5) and < 800 mm (set 6) prices on request.
Preis für Flügelbreite min. 700 mm (set 3-4-5) und 800 mm (set 6) mit einer Ausfahrt. Flügelbreite < 700 mm (set 3-4-5) und < 800 mm (set 6) Preis auf Anfrage.

> SET 7

- Prezzo su richiesta
- Price on request
- Preis auf Anfrage



- Trasporto fuori standard. Vedi condizioni di vendita
- Non-standard transport. See sales conditions
- Sondertransport. Siehe AGB

BALCONGLAS FALCE PARK-ISO

► PARETI MOBILI 126/129

C.321

- Sistema senza canalina. Maniglia e cilindro inclusi
- System without bottom guide. Handle and cylinder included
- System ohne Bodenführung. Türgriffe und Zylinder enthalten

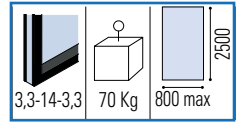

BG-ISO-PARK SET 2

LB = 2000 mm

AN

2 ante | panels

€ 3835,30

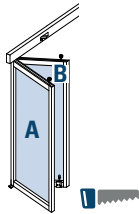

BG-ISO-PARK SET 3

LB = 3000 mm

AN

3 ante | panels

€ 5445,70

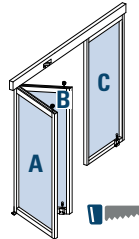

BG-ISO-PARK SET 4

LB = 4000 mm

AN

4 ante | panels

€ 7523,00

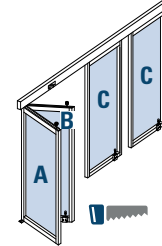

BG-ISO-PARK SET 5

LB = 5000 mm

AN

5 ante | panels

€ 8835,50

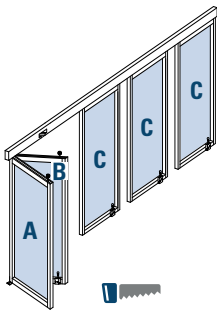

BG-ISO-PARK SET 6

LB = 6000 mm

AN

6 ante | panels

€ 9850,30

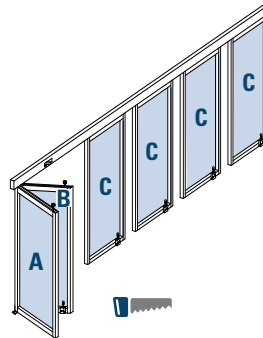

BG-ISO-PARK SET 7

LB = 6000 mm

AN

7 ante | panels

€ 10843,30

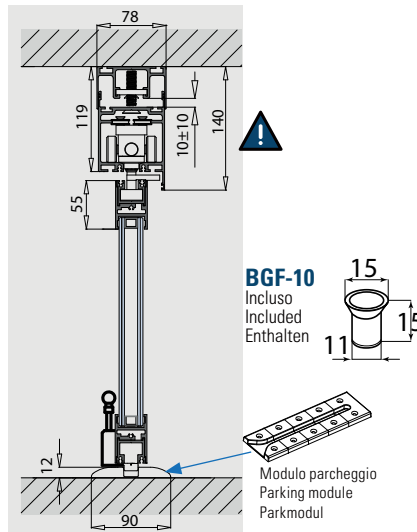
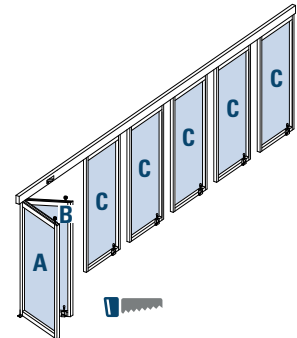

- Indicare sempre il verso di apertura e mandare il disegno fatto con [MY METALGLAS](#) al momento dell'ordine
- Please specify always opening direction and send technical drawing from [MY METALGLAS](#) when ordering
- Bitte immer Öffnungsrichtung und technische Zeichnung von [MY METALGLAS](#) bei der Bestellung angeben

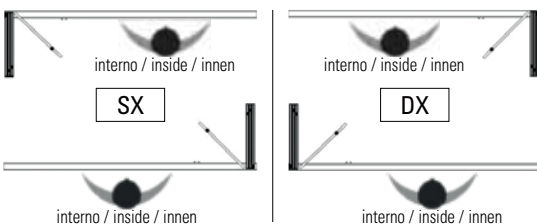

OPTIONAL	COD.	FIN	PRICE
	BGF-ISO-U	AN	€ 137,30
<ul style="list-style-type: none"> • Montante lato anta "U" • "U" side profile • "U" seitliches Profil 			
	BGF-ISO-L	AN	€ 107,50
<ul style="list-style-type: none"> • Montante lato porta "L" • "L" side profile • "L" seitliches Profil 			
	L-112-PA	CS	€ 34,70
<ul style="list-style-type: none"> • Pozzetto eccentrico • Eccentric floor socket • Exzenterbuchse verstellbar 			
	BG-13		€ 74,20
<ul style="list-style-type: none"> • Pinza doppia ferma pannelli • Fixation pin kit • Doppel klemme Flügel stopper 			

do-it-yourself

- Profili anta forniti in misura FIX L = 1000x3000 mm da tagliare cliente secondo schema [MY METALGLAS](#)
- Panel profiles supplied in standard length 1000x3000 mm cut by installer according to [MY METALGLAS](#) configurator
- Flügelprofile erhältlich in Fixlängen von 1000x3000 mm schnitt bauseitig gemäss Konfigurator [MY METALGLAS](#)

LG-500 | LG-500-12 | LG-550 LOGGIAGLAS 4x4

► PARETI MOBILI 132/145

C.322

- Sistema scorrevole telescopico studiato per balconi, logge e verande.
- Telescopic sliding system for balcony, Loggia and terrace.
- Teleskop Schiebetürsystem für Balkon und Loggiaverglasungen.

C1 = con 1 catenaccio | with 1 locking bolt | mit 1 Feststellriegel
C2 = con 2 catenaccioli 1 | with 2 locking bolts | mit 2 Feststellriegel

	AN	RAL 9010
LG-500 SET 2	€ 898,50	€ 958,70
LG-500-12 SET 2 for glass 12 mm*	€ 979,00	€ 1039,30
LG-550 SET 2	€ 749,30	€ 809,50

2 ante | panels LB = 3000 mm

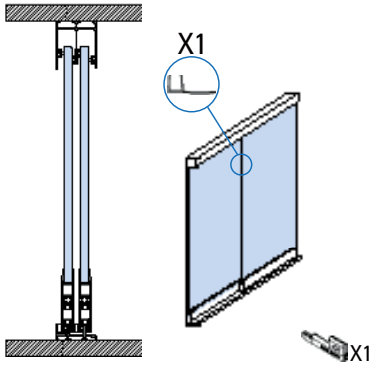

	AN	RAL 9010
LG-500 C1 SET 2	€ 1159,00	€ 1231,00
LG-500-12 C1 SET 2 for glass 12 mm*	€ 1239,50	€ 1311,30
LG-550 C1 SET 2	€ 1007,50	€ 1079,70

2 ante | panels LB = 3000 mm

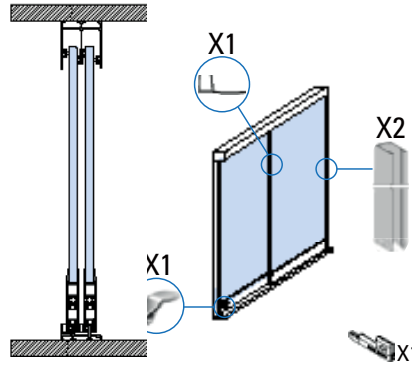

	AN	RAL 9010
LG-500 C2 SET 2	€ 1215,50	€ 1288,00
LG-500-12 C2 SET 2 for glass 12 mm*	€ 1296,30	€ 1368,50
LG-550 C2 SET 2	€ 1061,00	€ 1133,30

2 ante | panels LB = 3000 mm

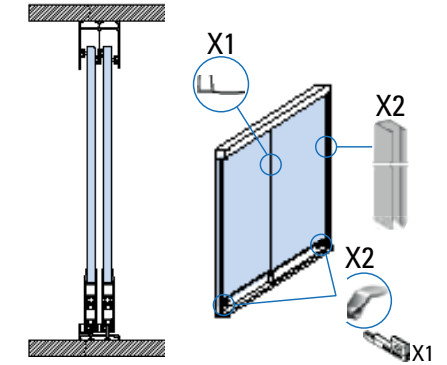

	AN	RAL 9010
LG-500 SET 3	€ 1180,00	€ 1252,30
LG-500-12 SET 3 for glass 12 mm*	€ 1294,70	€ 1363,50
LG-550 SET 3	€ 956,30	€ 1027,50

3 ante | panels LB = 3000 mm

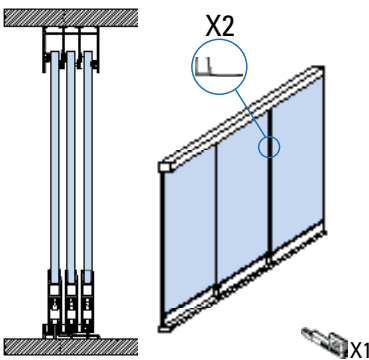

	AN	RAL 9010
LG-500 C1 SET 3	€ 1441,70	€ 1525,00
LG-500-12 C1 SET 3 for glass 12 mm*	€ 1556,30	€ 1636,30
LG-550 C1 SET 3	€ 1213,30	€ 1296,70

3 ante | panels LB = 3000 mm

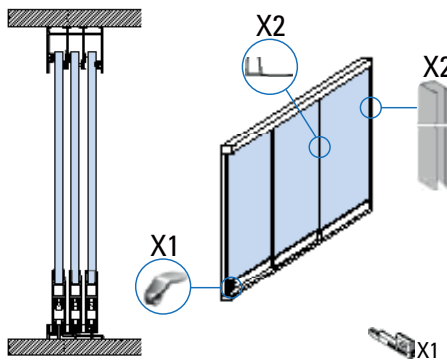

	AN	RAL 9010
LG-500 C2 SET 3	€ 1497,30	€ 1580,50
LG-500-12 C2 SET 3 for glass 12 mm*	€ 1612,00	€ 1692,00
LG-550 C2 SET 3	€ 1268,00	€ 1351,30

3 ante | panels LB = 3000 mm

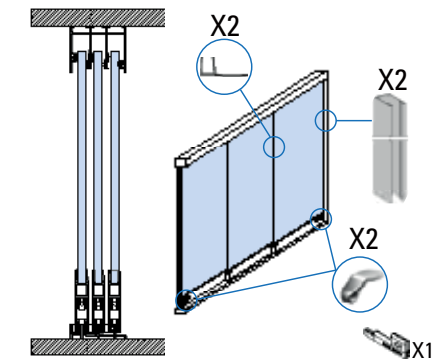

LG-500	LG-500-12
100 Kg	100 Kg
10	12
1200	1000
3000	
4 ruote per anta 4 wheels each panel 4 Rollen jede Flügel	



LG-550
60 Kg
10
1000
2500
2 ruote per anta 2 wheels each panel 2 Rollen jede Flügel

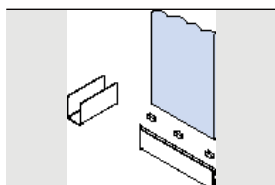

LG-526 (optional) CONSIGLIATO - RECOMMENDED - EMPFOHLEN

- Set di 3 pc "U" trasparenti per incollaggio perpendicolare vetro 10 mm al profilo anta
- Set of 3 pc transparent "U" support for perpendicular glueing of 10 mm glass to panel profile
- Set von 3 Stück transparenten U-Auflagen für 10 mm Glas zum passgenauen senkrechten einkleben ins Flügelprofil

3 pc

13,50/set
(1 set each panel)

- Tagliato dal cliente
- Cut by installer
- Schnitt bauseitig

TAGLIO-LG-SET

- Il costo per n° 3 tagli dei 3 profili componenti il set Loggiaglas è di € 62,00 a set
- The cost for 3 cuts of the 3 profiles composing the Loggiaglas set is € 62,00 per set
- Der Preis für 3 Schnitte der Profile, die zum Set Loggiaglas gehören, beträgt € 62,00 pro Set



- Trasporto fuori standard. Vedi condizioni di vendita
- Non-standard trasport. See sales conditions
- Sondertransport. Siehe AGB

C1 = con 1 catenacciolo | with 1 locking bolt | mit 1 Feststellriegel
C2 = con 2 catenaccioli | with 2 locking bolts | mit 2 Feststellriegel

	AN	RAL 9010
LG-500 SET 4	€ 1861,30	€ 2025,70
LG-500-12 SET 4 for glass 12 mm*	€ 2016,00	€ 2170,50
LG-550 SET 4	€ 1560,70	€ 1725,30

4 ante | panels LB = 5000 mm

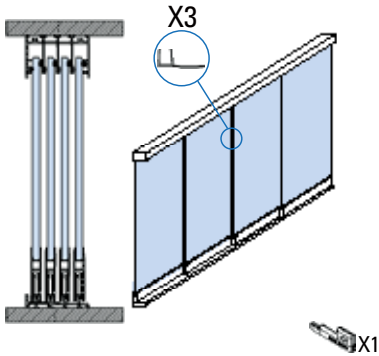

	AN	RAL 9010
LG-500 C1 SET 4	€ 2121,50	€ 2298,50
LG-500-12 C1 SET 4 for glass 12 mm*	€ 2277,30	€ 2443,30
LG-550 C1 SET 4	€ 1818,70	€ 1995,70

4 ante | panels LB = 5000 mm

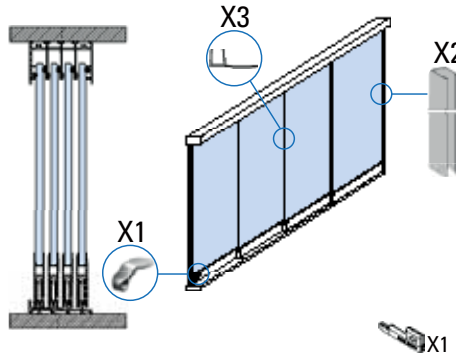

	AN	RAL 9010
LG-500 C2 SET 4	€ 2177,30	€ 2354,30
LG-500-12 C2 SET 4 for glass 12 mm*	€ 2333,30	€ 2499,00
LG-550 C2 SET 4	€ 1873,50	€ 2050,50

4 ante | panels LB = 5000 mm

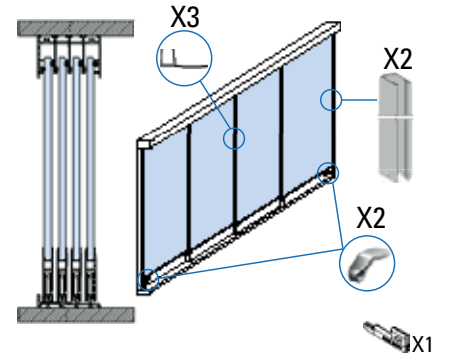

	AN	RAL 9010
LG-500 SET 5	€ 2412,30	€ 2592,30
LG-500-12 SET 5 for glass 12 mm*	€ 2601,30	€ 2771,50
LG-550 SET 5	€ 2037,00	€ 2217,30

5 ante | panels LB = 6000 mm

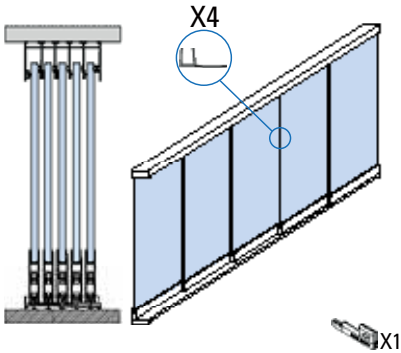

	AN	RAL 9010
LG-500 C1 SET 5	€ 2672,70	€ 2865,00
LG-500-12 C1 SET 5 for glass 12 mm*	€ 2861,70	€ 3044,50
LG-550 C1 SET 5	€ 2296,30	€ 2488,00

5 ante | panels LB = 6000 mm

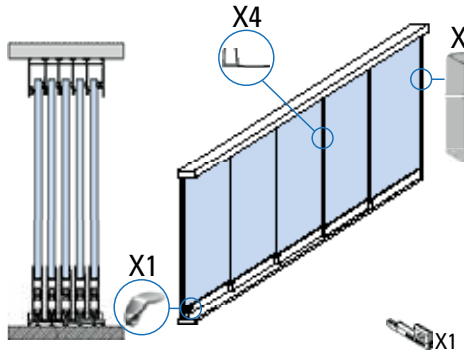

	AN	RAL 9010
LG-500 C2 SET 5	€ 2729,30	€ 2920,70
LG-500-12 C2 SET 5 for glass 12 mm*	€ 2918,50	€ 3100,00
LG-550 C2 SET 5	€ 2432,00	€ 2623,50

5 ante | panels LB = 6000 mm

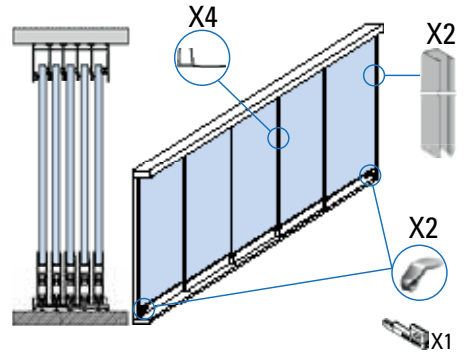

LG-500			LG-500-12			
4 ruote per anta 4 wheels each panel 4 Rollen jede Flügel						

LG-550			
2 ruote per anta 2 wheels each panel 2 Rollen jede Flügel			

	<p>LG-526 (optional) CONSIGLIATO - RECOMMENDED - EMPFOHLEN</p> <ul style="list-style-type: none"> Set di 3 pc "U" trasparenti per incollaggio perpendicolare vetro 10 mm al profilo anta Set of 3 pc transparent "U" support for perpendicular glueing of 10 mm glass to panel profile Set von 3 Stück transparenten U-Auflagen für 10 mm Glas zum passgenauen senkrechten einkleben ins Flügelprofil 	3 pc	<p>13,50 /set (1 set each panel)</p>
--	---	------	---

do-it-yourself

- Binario superiore, profili anta e canalina forniti in misura FIX da tagliare cliente secondo schema [MY METALGLAS](#)
- Top track profile, panel profiles and floor profile supplied in FIX length cut by installer according to [MY METALGLAS](#) configurator
- Laufschienenprofil, Flügelprofile und Bodenschiene in Fixlängen schnitt bauseitig gemäss Konfigurator [MY METALGLAS](#)

- * Guarnizione non inclusa
- Gasket not included
- Dichtung nicht enthalten

LG-510 | LG-510-12 | LG-560 LOGGIAGLAS 4x4

GUIDA A TERRA INCASSATA
RECESSED FLOOR GUIDE
VERSENKTE BODENSCHIENE

► PARETI MOBILI 132/145

C.323

- Sistema scorrevole telescopico studiato per balconi, logge e verande.
- Telescopic sliding system for balcony, Loggia and terrace.
- Teleskop Schiebetürsystem für Balkon und Loggiaverglasungen.

C1 = con 1 catenacciolo | with 1 locking bolt | mit 1 Feststellriegel
C2 = con 2 catenaccioli | with 2 locking bolts | mit 2 Feststellriegel

	AN	RAL 9010
LG-510 SET 2	€ 951,30	€ 1026,00
LG-510-12 SET 2 for glass 12 mm*	€ 1032,50	€ 1077,00
LG-560 SET 2	€ 795,50	€ 870,00

2 ante | panels LB = 3000 mm

	AN	RAL 9010
LG-510 C1 SET 2	€ 1193,00	€ 1287,50
LG-510-12 C1 SET 2 for glass 12 mm*	€ 1274,30	€ 1338,50
LG-560 C1 SET 2	€ 1033,50	€ 1128,30

2 ante | panels LB = 3000 mm

	AN	RAL 9010
LG-510 C2 SET 2	€ 1250,50	€ 1345,30
LG-510-12 C2 SET 2 for glass 12 mm*	€ 1332,00	€ 1396,50
LG-560 C2 SET 2	€ 1088,30	€ 1182,70

2 ante | panels LB = 3000 mm

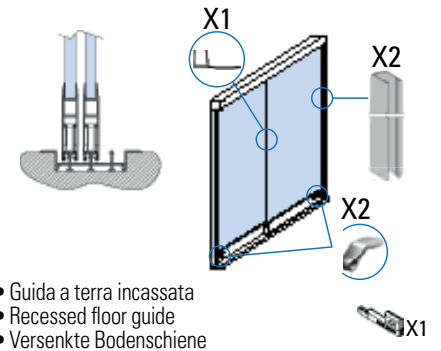
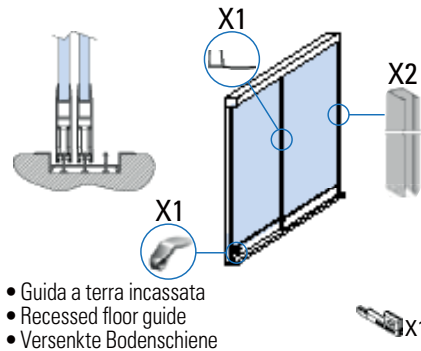
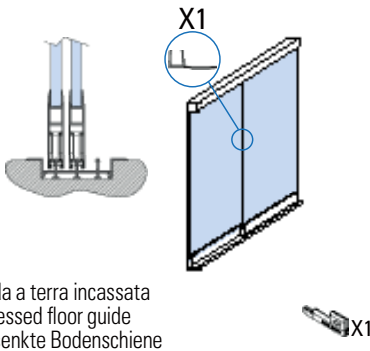

	AN	RAL 9010
LG-510 SET 3	€ 14,77	€ 1260,70
LG-510-12 SET 3 for glass 12 mm*	€ 1300,70	€ 1345,30
LG-560 SET 3	€ 953,50	€ 1027,00

3 ante | panels LB = 3000 mm

	AN	RAL 9010
LG-510 C1 SET 3	€ 1428,70	€ 1522,30
LG-510-12 C1 SET 3 for glass 12 mm*	€ 1542,30	€ 1606,70
LG-560 C1 SET 3	€ 1192,00	€ 1285,30

3 ante | panels LB = 3000 mm

	AN	RAL 9010
LG-510 C2 SET 3	€ 1486,50	€ 1580,00
LG-510-12 C2 SET 3 for glass 12 mm*	€ 1601,30	€ 1666,00
LG-560 C2 SET 3	€ 1246,30	€ 1339,70

3 ante | panels LB = 3000 mm

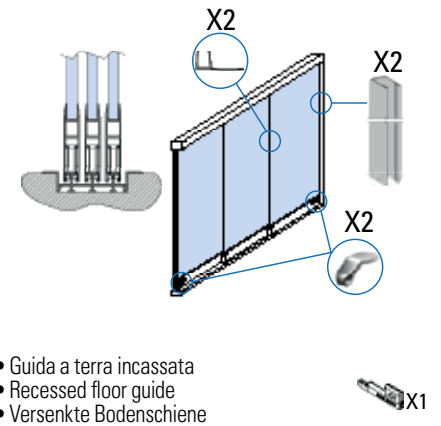
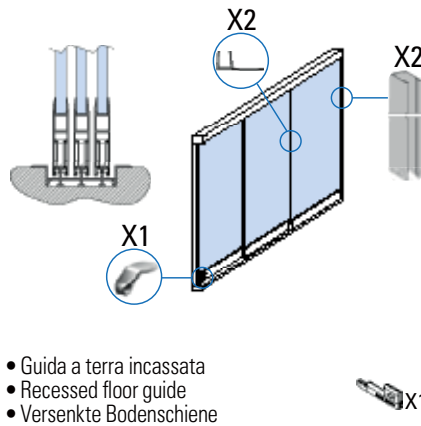
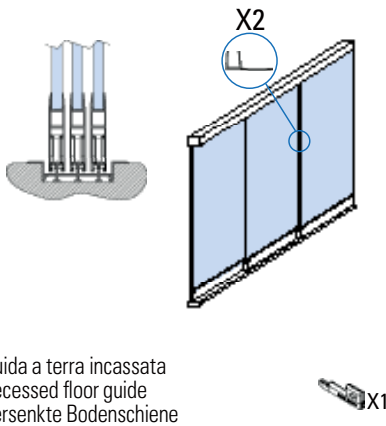

LG-510	LG-510-12	
100 Kg	100 Kg	
10	12	
1200	1000	
4 ruote per anta 4 wheels each panel 4 Rollen jede Flügel		

LG-560	
60 Kg	
10	
1000	
2 ruote per anta 2 wheels each panel 2 Rollen jede Flügel	

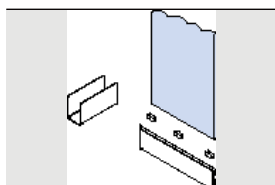

LG-526 (optional) CONSIGLIATO - RECOMMENDED - EMPFOHLEN

- Set di 3 pc "U" trasparenti per incollaggio perpendicolare vetro 10 mm al profilo anta
- Set of 3 pc transparent "U" support for perpendicular glueing of 10 mm glass to panel profile
- Set von 3 Stück transparenten U-Auflagen für 10 mm Glas zum passgenauen senkrechten einkleben ins Flügelprofil

3 pc

13,50/set
(1 set each panel)

Tagliato dal cliente
• Cut by installer
• Schnitt bauseitig

TAGLIO-LG-SET

- Il costo per n° 3 tagli dei 3 profili componenti il set Loggiaglas è di € 62,00 a set
- The cost for 3 cuts of the 3 profiles composing the Loggiaglas set is € 62,00 per set
- Der Preis für 3 Schnitte der Profile, die zum Set Loggiaglas gehören, beträgt € 62,00 pro Set



- Trasporto fuori standard. Vedi condizioni di vendita
- Non-standard transport. See sales conditions
- Sondertransport. Siehe AGB

C1 = con 1 catenacciolo | with 1 locking bolt | mit 1 Feststellriegel
C2 = con 2 catenaccioli | with 2 locking bolts | mit 2 Feststellriegel

	AN	RAL 9010
LG-510 SET 4	€ 1865,00	€ 2005,30
LG-510-12 SET 4 for glass 12 mm*	€ 2020,70	€ 2107,70
LG-560 SET 4	€ 1554,50	€ 1693,70

4 ante | panels LB = 5000 mm

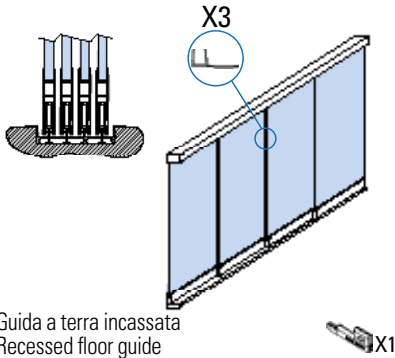

- Guida a terra incassata
- Recessed floor guide
- Versenkte Bodenschiene

	AN	RAL 9010
LG-510 C1 SET 4	€ 2107,70	€ 2267,00
LG-510-12 C1 SET 4 for glass 12 mm*	€ 2262,50	€ 2369,30
LG-560 C1 SET 4	€ 1793,00	€ 1952,00

4 ante | panels LB = 5000 mm

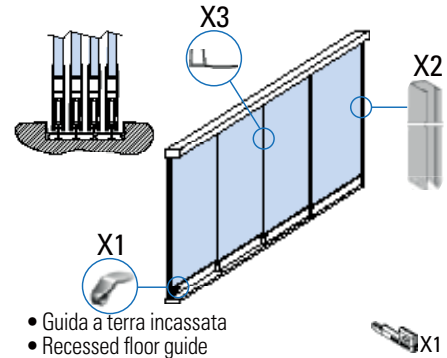

- Guida a terra incassata
- Recessed floor guide
- Versenkte Bodenschiene

	AN	RAL 9010
LG-510 C2 SET 4	€ 2165,70	€ 2324,70
LG-510-12 C2 SET 4 for glass 12 mm*	€ 2321,50	€ 2427,30
LG-560 C2 SET 4	€ 1828,30	€ 1987,50

4 ante | panels LB = 5000 mm

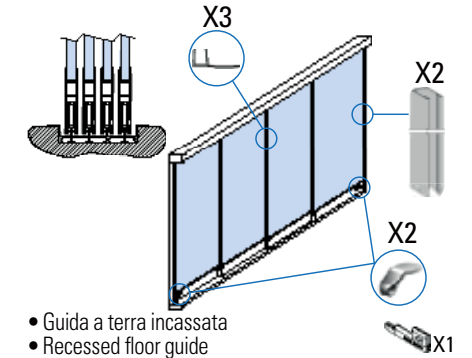

- Guida a terra incassata
- Recessed floor guide
- Versenkte Bodenschiene

	AN	RAL 9010
LG-510 SET 5	€ 2392,50	€ 2574,00
LG-510-12 SET 5 for glass 12 mm*	€ 2580,70	€ 2711,00
LG-560 SET 5	€ 2004,30	€ 2185,50

5 ante | panels LB = 6000 mm

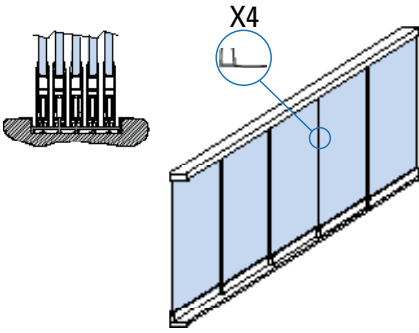

- Guida a terra incassata
- Recessed floor guide
- Versenkte Bodenschiene

	AN	RAL 9010
LG-510 C1 SET 5	€ 2634,30	€ 2835,50
LG-510-12 C1 SET 5 for glass 12 mm*	€ 2823,50	€ 2972,70
LG-560 C1 SET 5	€ 2242,30	€ 2443,70

5 ante | panels LB = 6000 mm

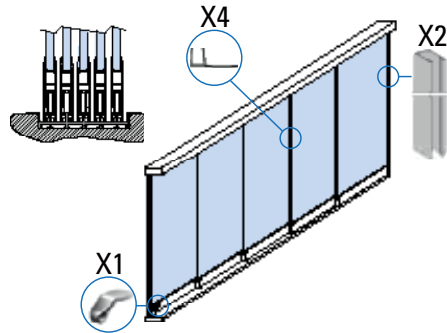

- Guida a terra incassata
- Recessed floor guide
- Versenkte Bodenschiene

	AN	RAL 9010
LG-510 C2 SET 5	€ 2692,00	€ 2894,70
LG-510-12 C2 SET 5 for glass 12 mm*	€ 2881,30	€ 3030,30
LG-560 C2 SET 5	€ 2268,00	€ 2469,30

5 ante | panels LB = 6000 mm

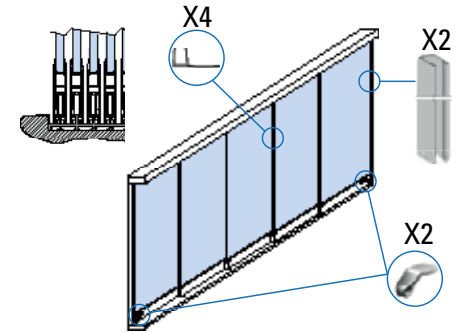

- Guida a terra incassata
- Recessed floor guide
- Versenkte Bodenschiene

LG-510	LG-510-12	LG-560
100 Kg	100 Kg	60 Kg
10	12	10
1200	1000	1000
3000	3000	2500
4 ruote per anta 4 wheels each panel 4 Rollen jede Flügel		2 ruote per anta 2 wheels each panel 2 Rollen jede Flügel

	LG-526 (optional) CONSIGLIATO - RECOMMENDED - EMPFOHLEN <ul style="list-style-type: none"> • Set di 3 pc "U" trasparenti per incollaggio perpendicolare vetro 10 mm al profilo anta • Set of 3 pc transparent "U" support for perpendicular glueing of 10 mm glass to panel profile • Set von 3 Stück transparenten U-Auflagen für 10 mm Glas zum passgenauen senkrechten einkleben ins Flügelprofil 	3 pc	13,50 /set (1 set each panel)
--	--	------	---

do-it-yourself

- Binario superiore, profili anta e canalina forniti in misura FIX da tagliare cliente secondo schema [MY METALGLAS](#)
- Top track profile, panel profiles and floor profile supplied in FIX length cut by installer according to [MY METALGLAS](#) configurator
- Laufschienenprofil, Flügelprofile und Bodenschiene in Fixlängen schnitt bauseitig gemäss Konfigurator [MY METALGLAS](#)

- * Guarnizione non inclusa
- Gasket not included
- Dichtung nicht enthalten

POS.	PROD.	ART.	MIS.	Q.TÀ	FIN.	EURO	FIN.	EURO
LG-500 LG-500-12 LG-550 LG-510 LG-510-12 LG-560 LOGGIAGLAS ▲ PARETI MOBILI 146/147								
COMPONENTI / COMPONENTS / EINZELTEILE								
C.323.1		LG-528 • Setola non inclusa • Brush seal not included • Bürstendichtungen nicht enthalten	3000 mm	1 pc	AN	142,70 /pc	RAL 9010	166,00 /pc
			6000 mm	1 pc	AN	275,70 /pc	RAL 9010	318,00 /pc
C.324		LG-501 • Setola non inclusa • Brush seal not included • Bürstendichtungen nicht enthalten	3000 mm	1 pc	AN	181,70 /pc	RAL 9010	211,50 /pc
			6000 mm	1 pc	AN	336,50 /pc	RAL 9010	392,00 /pc
C.325		LG-504 • Setola non inclusa • Brush seal not included • Bürstendichtungen nicht enthalten	5000 mm	1 pc	AN	343,00 /pc	RAL 9010	400,70 /pc
C.326		LG-513 • Setola non inclusa • Brush seal not included • Bürstendichtungen nicht enthalten	6000 mm	1 pc	AN	496,50 /pc	RAL 9010	579,00 /pc
C.326.1		LG-529 • Con fori per scarico acqua • With preparation for drain • Mit Profilbearbeitung für Abfluss	3000 mm	1 pc	AN	107,30 /pc	RAL 9010	125,00 /pc
			6000 mm	1 pc	AN	186,30 /pc	RAL 9010	218,50 /pc
C.327		LG-502	3000 mm	1 pc	AN	130,00 /pc	RAL 9010	152,30 /pc
			6000 mm	1 pc	AN	218,50 /pc	RAL 9010	258,50 /pc
C.328		LG-503	3000 mm	1 pc	AN	142,70 /pc	RAL 9010	168,30 /pc
			6000 mm	1 pc	AN	258,50 /pc	RAL 9010	306,50 /pc
C.329		LG-506	5000 mm	1 pc	AN	245,70 /pc	RAL 9010	318,00 /pc

- Tagliato dal cliente
- Cut by installer
- Schnitt bauseitig

TAGLIO-LG-SET

- Il costo per n° 3 tagli dei 3 profili componenti il set Loggiaglas è di € 62,00 a set
- The cost for 3 cuts of the 3 profiles composing the Loggiaglas set is € 62,00 per set
- Der Preis für 3 Schnitte der Profile, die zum Set Loggiaglas gehören, beträgt € 62,00 pro Set

- Trasporto fuori standard. Vedi condizioni di vendita
- Non-standard trasport. See sales conditions
- Sondertransport. Siehe AGB

LG-500 LG-500-12 LG-503 LG-510 LG-510-12 LG-560 LOGGIAGLAS							▲ PARETI MOBILI 146/147	
COMPONENTI / COMPONENTS / EINZELTEILE								
C.330		LG-507	5000 mm	1 pc	AN	262,00/pc	RAL 9010	311,70/pc
C.331		LG-514	6000 mm	1 pc	AN	346,00/pc	RAL 9010	408,30/pc
C.332		LG-515	6000 mm	1 pc	AN	413,30/pc	RAL 9010	348,50/pc
C.333		LG-505	3000 mm	1 pc	AN	125,00/pc	RAL 9010	144,70/pc
			6000 mm	1 pc	AN	222,70/pc	RAL 9010	257,30/pc
C.334		LG-505-12	3000 mm	1 pc	AN	139,30/pc	RAL 9010	144,70/pc
			6000 mm	1 pc	AN	245,00/pc	RAL 9010	256,00/pc
C.335		LG-508	3000 mm	1 pc	AN	76,00/pc	RAL 9010	84,00/pc
			6000 mm	1 pc	AN	120,50/pc	RAL 9010	133,70/pc
		LG-527-CF2	3000 mm	1 set	AN	182,70/set	RAL 9010	200,50/set
			6000 mm	1 set	AN	323,00/set	RAL 9010	378,50/set
C.336		LG-509	<ul style="list-style-type: none"> • 2 ruote per carrello • 2 wheels each trolley • 2 Rollen pro Laufwagen 	1 pc	AG	96,00/pc		
				LG-509-12	<ul style="list-style-type: none"> • Per vetro 12 mm • For glass 12 mm • Für glass 12 mm 	1 pc	AG	112,70/pc
C.337		LG-510	<ul style="list-style-type: none"> • 2 ruote per carrello • 2 wheels each trolley • 2 Rollen pro Laufwagen 	1 pc	AG	102,50/pc		
				LG-510-12	<ul style="list-style-type: none"> • Per vetro 12 mm • For glass 12 mm • Für glass 12 mm 	1 pc	AG	119,30/pc

do-it-yourself

- Binario superiore, profili anta e canalina forniti in misura FIX da tagliare cliente secondo schema [MY METALGLAS](#)
- Top track profile, panel profiles and floor profile supplied in FIX length cut by installer according to [MY METALGLAS](#) configurator
- Laufschieneprofil, Flügelprofile und Bodenschiene in Fixlängen schnitt bauseitig gemäss Konfigurator [MY METALGLAS](#)

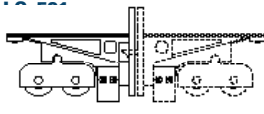
POS.	PROD.	ART.	MIS.	Q.TÀ	FIN.	EURO	FIN.	EURO
LG-500 LG-500-12 LG-550 LG-510 LG-510-12 LG-560 LOGGIAGLAS COMPONENTI / COMPONENTS / EINZELTEILE								▲ PARETI MOBILI 146/147
C.338		LG-519 • 1 ruota per carrello • 1 wheel each trolley • 1 Rolle pro Laufwagen		1 pc	AG	67,00 /pc		
C.339		LG-520 • 1 ruota per carrello • 1 wheel each trolley • 1 Rolle pro Laufwagen		1 pc	AG	75,00 /pc		
C.340		 LG-521 LG-510 not included		1 pc	AG	152,70 /pc		
C.341		LG-511 • Pomolo singolo per catenacciolo • Single locking bolt • Knopf für Feststeller		1 pc	CP	32,50 /pc		
C.342		LG-512 • Pomolo doppio per catenacciolo • Double locking bolt • Paar Knöpfe für Feststeller		1 pc	CP	44,70 /pc		
C.343		LG-517 • Chiave di manutenzione sgancio ante dal sistema antisollelevamento • Maintenance tool to release the panels from the anti-lifting mechanism • Revisionswerkzeug um die Türen aus dem Aushebeschutzsystem zu anheben		1 pc		30,30 /pc		
C.344		LG-518 2900 mm	1 pc			31,30 /pc		
		LG-518 2900 mm	■ min 30 pcs			23,50 /pc		
C.345		LG-522 • Setola per binari superiori per vetro 10 mm • Brush seal for track profiles for glass 10 mm • Bürstendichtungen für Laufschieneprofil für Glas 10 mm				5,70 /m		
C.346		LG-523 • Setola per binari superiori per vetro 12 mm • Brush seal for track profiles for glass 12 mm • Bürstendichtungen für Laufschieneprofil für Glas 12 mm				/m		
C.347		LG-524 • Setola per montante laterale LG-508 • Brush seal for "U" side profile LG-508 • Bürstendichtungen für "U"-seitliches Profil LG-508				4,30 /m		
C.348		LG-525 3000 mm				non disponibile not available nicht verfügbar		
C.349		LG-526 (optional) CONSIGLIATO - RECOMMENDED - EMPFOHLEN • Set di 3 pc "U" trasparenti per incollaggio perpendicolare vetro 10 mm al profilo anta • Set of 3 pc transparent "U" support for perpendicular glueing of 10 mm glass to panel profile • Set von 3 Stück transparenten U-Auflagen für 10 mm Glas zum passgenauen senkrechten einkleben ins Flügelprofil		3 pcs		13,50 /set (1 set each panel)		

POS.	PROD.	ART.	MIS.	Q.TÀ	FIN.	EURO	FIN.	EURO
LG-500 LG-500-12 LG-550 LG-510 LG-510-12 LG-560 LOGGIAGLAS								▲ PARETI MOBILI 146/147
ACCESSORI / ACCESSORIES / ZUBEHÖRE								

- Cilindri e contropiastre non inclusi, da ordinare a parte
- Cylinders and strike plates not included, to be ordered separately
- Zylinder und Schließbleche nicht enthalten, separat zu bestellen

C.345		V-574	1 pc	CP	137,30 /pc	NS	136,30 /pc		
		V-574	■ min 10 pcs	CP	116,30 /pc	NS	115,00 /pc		
C.346		V-569 2FLG	1 pc	CP	143,30 /pc	NS	146,70 /pc		
		V-569 2FLG	■ min 10 pcs	CP	117,50 /pc	NS	119,30 /pc		
C.347									
C.348		LG-516 <ul style="list-style-type: none"> • Contropiastre per serratura V-564 e carrelli LG-510 / LG-520 con montante LG-508 • Strike plate for lock V-564 and rollers LG-510 / LG-520 with "U" side profile LG-508 • Schließblech für Schloss V-564 und Laufwagen LG-510 / LG-520 mit "U"-seitlichem Profil LG-508 	1 pc	IX	21,30 /pc				
C.349		C-010	1 pc	CR	28,00 /pc				
C.350		C-011	1 pc	CP	62,00 /pc				
C.351		C-012	1 pc	CP	68,30 /pc				
C.352		C-015 <ul style="list-style-type: none"> • Mezzo cilindro con un lato cieco • Half cylinder with one blind side • Halb-Zylinder mit einer Seite blind 	1 pc	NS	29,70 /pc				
C.353		V-524	1 pair	CP	60,00 /pair	NS	60,00 /pair	CR	55,70 /pair
		V-524	■ min 10 pairs	CP	47,50 /pair	NS	47,50 /pair	CR	44,70 /pair
C.353.1		LG-533 <ul style="list-style-type: none"> • Sistema scarico acqua laterale per guida inferiore 3 vie • Side drainage system for 3-ways floor profile • Seitliches Entwässerungssystem für 3-läufige Bodenschiene 	2 pcs		36,30 /set				
C.353.2		LG-534 <ul style="list-style-type: none"> • Sistema scarico acqua laterale per guida inferiore 4 vie • Side drainage system for 4-ways floor profile • Seitliches Entwässerungssystem für 4-läufige Bodenschiene 	2 pcs		36,30 /set				
C.353.3		LG-535 <ul style="list-style-type: none"> • Sistema scarico acqua laterale per guida inferiore 5 vie • Side drainage system for 5-ways floor profile • Seitliches Entwässerungssystem für 5-läufige Bodenschiene 	2 pcs		36,30 /set				

■ min

- Prezzi speciali per l'acquisto delle quantità minime indicate dell'articolo. NB eventuali riordini o aggiunte per completamenti se di quantità inferiore alla minima, saranno fatturati al prezzo normale
- Special prices for the purchase of the minimum quantities indicated of the article. Note Well: any reorders or additions for completions of quantity less than the minimum will be invoiced at the normal price.
- Artikel mit Sonderpreisen bei Mindestabnahmemengen sind mit gekennzeichnet. Nachbestellungen oder Ergänzungen unter der Mindestabnahmemenge werden mit dem Normalpreis verrechnet.

POS.	PROD.	ART.	Q.TÀ	FIN.	EURO	FIN.	EURO	FIN.	EURO
<p>CATENACCIOLI SENZA VITI A VISTA LOCKING BOLT WITH NOT VISIBLE SCREWS / FESTSTELLER OHNE SICHTBAREN SCHRAUBEN</p>									
	V-784	1 pc	CR	124,30 /pc	NS	123,00 /pc	CP	115,70 /pc	
	V-784	■ min 10 pcs	CR	110,00 /pc	NS	110,00 /pc	CP	103,00 /pc	
<ul style="list-style-type: none"> • Tappo cieco • Blind • Blind 	V-784 PO-TC	1 pc			NS	180,30 /pc	CP	168,70 /pc	
	V-784 PO-TC	■ min 10 pcs			NS	162,30 /pc	CP	148,50 /pc	
	V-789 2FLG	1 pc	CR	 SVY /pc	NS	 SVZ /pc	CP	 SWA /pc	
	V-789 2FLG	■ min 10 pcs	CR	 SWB /pc	NS	 SWC /pc	CP	 SWD /pc	
		LG-516-N	1 pc	IX	23,50 /pc				
	<ul style="list-style-type: none"> • Lavorazione vetro standard • Standard glass preparation • Standard Gasbearbeitung 				<ul style="list-style-type: none"> • Lavorazione vetro per montante LG-508 • Glass preparation for U-profile LG-508 • Gasbearbeitung für U-Profil LG-508 				

POS.	PROD.	ART.	Q.TÀ	FIN.	EURO	FIN.	EURO	FIN.	EURO
CATENACCIOLI CON VITI A VISTA LOCKING BOLT WITH VISIBLE SCREWS / FESTSTELLER MIT SICHTABAREN SCHRAUBEN									
		V-764	1 pc	CP	100,30 /pc				
		V-764	■ min 10 pcs	CP	90,30 /pc				
	<ul style="list-style-type: none"> • Tappo cieco • Blind • Blind 	V-764 PO-TC	1 pc	CP	139,00 /pc				
		V-764 PO-TC	■ min 10 pcs	CP	122,00 /pc				
		V-769 2FLG	1 pc	CP	54,30 /pc				
		V-769 2FLG	■ min 10 pcs	CP	45,70 /pc				
		LG-516-N	1 pc	IX	23,50 /pc				
	<ul style="list-style-type: none"> • Lavorazione vetro standard • Standard glass preparation • Standard Gasbearbeitung 					<ul style="list-style-type: none"> • Lavorazione vetro per montante LG-508 • Glass preparation for U-profile LG-508 • Gasbearbeitung für U-Profil LG-508 			

min











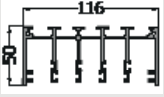

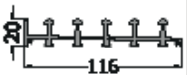

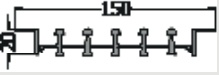

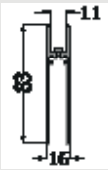





- Prezzi speciali per l'acquisto delle quantità minime indicate dell'articolo. NB eventuali riordini o aggiunte per completamenti se di quantità inferiore alla minima, saranno fatturati al prezzo normale
- Special prices for the purchase of the minimum quantities indicated of the article. Note Well: any reorders or additions for completions of quantity less than the minimum will be invoiced at the normal price.
- Artikel mit Sonderpreisen bei Mindestabnahmemengen sind mit gekennzeichnet. Nachbestellungen oder Ergänzungen unter der Mindestabnahmemenge werden mit dem Normalpreis verrechnet.

PROD.	ART.	MIS.	Q.TÀ	EURO	EURO	
LG-500-MIX industriali - industrial packaging - Industrieverpackungen				FINITURE FINISHES OBERFLÄCHEN	AN - BI	GR
2 VIE - 2 ways - 2 läufig						
	min ⚠ x2	LG-528-16	6100 mm	■ mix 16 pc	292,30 /pc	261,30 /pc
		LG-528-80	6100 mm	■ mix 80 pc	254,70 /pc	208,70 /pc
	min ⚠ x2	LG-529-16	6100 mm	■ mix 16 pc	184,30 /pc	170,30 /pc
		LG-529-80	6100 mm	■ mix 80 pc	154,30 /pc	131,70 /pc
3 VIE - 3 ways - 3 läufig						
	min ⚠ x2	LG-501-16	6100 mm	■ mix 16 pc	337,30 /pc	297,50 /pc
		LG-501-80	6100 mm	■ mix 80 pc	293,30 /pc	239,70 /pc
	min ⚠ x2	LG-502-16	6100 mm	■ mix 16 pc	211,00 /pc	191,70 /pc
		LG-502-80	6100 mm	■ mix 80 pc	182,00 /pc	147,70 /pc
	min ⚠ x2	LG-503-16	6100 mm	■ mix 16 pc	244,00 /pc	219,50 /pc
		LG-503-80	6100 mm	■ mix 80 pc	213,00 /pc	173,50 /pc
4 VIE - 4 ways - 4 läufig						
	min ⚠ x2	LG-504-16	5100 mm	■ mix 16 pc	343,50 /pc	303,00 /pc
		LG-504-80	5100 mm	■ mix 80 pc	303,00 /pc	248,30 /pc
	min ⚠ x2	LG-506-16	5100 mm	■ mix 16 pc	222,70 /pc	201,30 /pc
		LG-506-80	5100 mm	■ mix 80 pc	190,50 /pc	155,30 /pc
	min ⚠ x2	LG-507-16	5100 mm	■ mix 16 pc	249,50 /pc	223,70 /pc
		LG-507-80	5100 mm	■ mix 80 pc	218,30 /pc	176,70 /pc

- Confezioni industriali
- Industrial packaging
- Industrieverpackungen

- ⚠ Confezioni profili con quantità fissa, disponibili solo in multipli della quantità indicata.
- Packs of profiles with fixed quantity, available only in multiples of the indicated quantity.
- Profilpackungen mit fixer Menge sind nur als Vielfaches der angeführten Menge erhältlich.

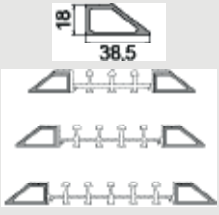
- 🚚 6100 mm
- Trasporto fuori standard. Vedi condizioni di vendita
- Non-standard transport. See sales conditions
- Sondertransport. Siehe AGB

PROD.	ART.	MIS.	Q.TÀ	EURO	EURO			
				FINITURE FINISHES OBERFLÄCHEN				
				AN - BI	GR			
5 VIE - 5 ways - 5 läufig								
	min  x2	LG-513-16	6100 mm	■ mix 16 pc	478,30 /pc	417,30 /pc		
		LG-513-80	6100 mm	■ mix 80 pc	425,00 /pc	349,00 /pc		
	min  x2	LG-514-16	6100 mm	■ mix 16 pc	306,30 /pc	271,00 /pc		
		LG-514-80	6100 mm	■ mix 80 pc	268,70 /pc	218,30 /pc		
solo finitura AN - only finish AN*								
	min  x2	LG-515-16	6100 mm	■ mix 16 pc	337,30 /pc	297,50 /pc		
		LG-515-80	6100 mm	■ mix 80 pc	302,00 /pc	245,30 /pc		
solo finitura AN - only finish AN*								
PROFILI ANTA - panel profile - Profil für Tür								
		LG-505-16	6100 mm	■ mix 16 pc	min  x2	222,70 /pc	min  x3	202,30 /pc
		LG-505-80	6100 mm	■ mix 80 pc	min  x2	175,50 /pc	min  x3	149,00 /pc
		LG-505-12-16	6100 mm	■ mix 16 pc	min  x2	233,30 /pc	min  x3	213,00 /pc
		LG-505-12-80	6100 mm	■ mix 80 pc	min  x2	186,30 /pc	min  x3	159,50 /pc
MONTANTE LATERALE - "U" side profile - "U"-seitliches Profil								
		LG-508-16	6100 mm	■ mix 16 pc	min  x8	119,00 /pc	min  x4	101,70 /pc
		LG-508-80	6100 mm	■ mix 80 pc	min  x8	95,30 /pc	min  x4	78,30 /pc
SCIVOLO - ramp - Rampe								
	min  x8	LG-527-16	6100 mm	■ mix 16 pc	166,00 /pc	150,00 /pc		
		LG-527-80	6100 mm	■ mix 80 pc	141,30 /pc	115,70 /pc		

16 / 80 MIX

- Minimo ordine 16 o 80 pezzi, anche assortiti, fra i vari profili
- Minimum order 16 or 80 pc, also for combinations of various profiles
- Mindestbestellmenge 16 oder 80 Stück, auch sortiert nach verschiedenen Profilen

*
 • Guida a pavimento fornita solo in finitura AN per un migliore scorrimento dei carrelli e per evitare futuri scrostamenti del colore
 • Floor guide available only in AN anodized finishing due to a better slides of the rollers and to prevent the surface from scratching
 • Bodenführung nur in AN eloxierter Oberfläche erhältlich, da die Rollen besser gleiten und die Oberfläche nicht zerkratzt wird

PROD.	ART.	MIS.	Q.TÀ	EURO	EURO
LG-500 PACCHI industriali - industrial packaging - Industriepakete				FINITURE FINISHES OBERFLÄCHEN AN - BI	GR
2 VIE - 2 ways - 2 läufig					
	ELG-528	6100 mm	⚠ 12 pcs	207,70 /pc	-
		6100 mm	⚠ ≈ 35 pcs ^	-	169,30 /pc
	ELG-529	6100 mm	⚠ 12 pcs	134,00 /pc solo finitura AN - only finish AN*	-
		6100 mm	⚠ ≈ 62 pcs ^	-	100,70 /pc
3 VIE - 3 ways - 3 läufig					
	ELG-501	6100 mm	⚠ 18 pcs	258,00 /pc	-
		6100 mm	⚠ ≈ 27 pcs ^	-	208,70 /pc
	ELG-502	6100 mm	⚠ 18 pcs	158,50 /pc solo finitura AN - only finish AN*	-
		6100 mm	⚠ ≈ 46 pcs ^	-	122,00 /pc
	ELG-503	6100 mm	⚠ 18 pcs	187,30 /pc solo finitura AN - only finish AN*	-
		6100 mm	⚠ ≈ 38 pcs ^	-	147,70 /pc
4 VIE - 4 ways - 4 läufig					
	ELG-504	5100 mm	⚠ 18 pcs	266,50 /pc	-
		5100 mm	⚠ ≈ 26 pcs ^	-	216,30 /pc
	ELG-506	5100 mm	⚠ 18 pcs	168,00 /pc solo finitura AN - only finish AN*	-
		5100 mm	⚠ ≈ 43 pcs ^	-	130,70 /pc
	ELG-507	5100 mm	⚠ 18 pcs	191,70 /pc solo finitura AN - only finish AN*	-
		5100 mm	⚠ ≈ 37 pcs ^	-	151,00 /pc



- Confezioni profili con quantità fissa, disponibili solo in multipli della quantità indicata.
- Packs of profiles with fixed quantity, available only in multiples of the indicated quantity.
- Profilpackungen mit fixer Menge sind nur als Vielfaches der angeführten Menge erhältlich.



6100 mm



- Trasporto fuori standard. Vedi condizioni di vendita
- Non-standard transport. See sales conditions
- Sondertransport. Siehe AGB

PROD.	ART.	MIS.	Q.TÀ	EURO	EURO
				FINITURE FINISHES OBERFLÄCHEN	
				AN - BI	GR
5 VIE - 5 ways - 5 läufig					
	ELG-513	6100 mm	⚠ 15 pcs	375,70 /pc	-
		6100 mm	⚠ ≈ 18 pcs ^	-	308,30 /pc
	ELG-514	6100 mm	⚠ 18 pcs	235,50 /pc	-
		6100 mm	⚠ ≈ 30 pcs ^	solo finitura AN - only finish AN*	
	ELG-515	6100 mm	⚠ 18 pcs	263,30 /pc	-
		6100 mm	⚠ ≈ 26 pcs ^	solo finitura AN - only finish AN*	
PROFILI ANTA - panel profile - Profil für Tür					
	ELG-505	6100 mm	⚠ 20 pcs	158,50 /pc	-
		6100 mm	⚠ ≈ 48 pcs ^	-	124,30 /pc
	ELG-505-12	6100 mm	⚠ 20 pcs	169,30 /pc	-
		6100 mm	⚠ ≈ 53 pcs ^	-	135,00 /pc
MONTANTE LATERALE - "U" side profile - "U"-seitliches Profil					
	ELG-508	6100 mm	⚠ 24 pcs	76,00 /pc	-
		6100 mm	⚠ ≈ 104 pcs ^	-	53,50 /pc

^

- La quantità precisa delle barre verrà comunicata prima della partenza del materiale
- The correct quantity of the bars will be communicated at the departure of the material
- Die präzise Menge der Stangen wird bei der Abgabe des Materials mitgeteilt

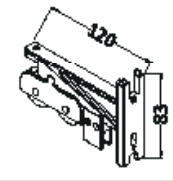
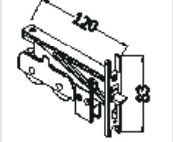
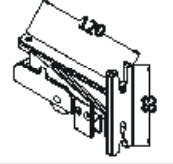
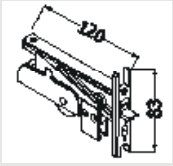





*
 • Guida a pavimento fornita solo in finitura AN per un migliore scorrimento dei carrelli e per evitare futuri scrostamenti del colore
 • Floor guide available only in AN anodized finishing due to a better slides of the rollers and to prevent the surface from scratching
 • Bodenführung nur in AN eloxierter Oberfläche erhältlich, da die Rollen besser gleiten und die Oberfläche nicht zerkratzt wird

PROD.	DESCRIPTION	ART.	MIS.	Q.TÀ	EURO	EURO
LG-500					FINITURE FINISHES OBERFLÄCHEN	
					AG	GR*
2 RUOTE - wheels - Räder						
	<ul style="list-style-type: none"> • Carrello per vetro 10 mm • Roller for glass 10 mm • Laufwagen für Glas 10 mm 	LG-509-30	■ mix 30 pcs	78,00 /pc	76,00 /pc	
		LG-509-100	■ mix 100 pcs	71,50 /pc	69,30 /pc	
		LG-509-300	■ mix 300 pcs	62,00 /pc	60,30 /pc	
	<ul style="list-style-type: none"> • Carrello per vetro 12 mm • Roller for glass 12 mm • Laufwagen für Glas 12 mm 	LG-509-12-30	■ mix 30 pcs	94,70 /pc	92,70 /pc	
		LG-509-12-100	■ mix 100 pcs	88,00 /pc	86,00 /pc	
		LG-509-12-300	■ mix 300 pcs	79,00 /pc	77,00 /pc	
	<ul style="list-style-type: none"> • Catenacciolo per vetro 10 mm • Locking bolt for glass 10 mm • Feststeller für Glas 10 mm 	LG-510-30	■ mix 30 pcs	85,00 /pc	82,50 /pc	
		LG-510-100	■ mix 100 pcs	79,30 /pc	77,00 /pc	
		LG-510-300	■ mix 300 pcs	71,50 /pc	69,30 /pc	
	<ul style="list-style-type: none"> • Catenacciolo per vetro 12 mm • Locking bolt for glass 12 mm • Feststeller für Glas 12 mm 	LG-510-12-30	■ mix 30 pcs	101,50 /pc	99,30 /pc	
		LG-510-12-100	■ mix 100 pcs	96,00 /pc	93,70 /pc	
		LG-510-12-300	■ mix 300 pcs	88,00 /pc	86,00 /pc	
1 RUOTA - wheel - Rad						
	<ul style="list-style-type: none"> • Carrello per vetro 10 mm • Roller for glass 10 mm • Laufwagen für Glas 10 mm 	LG-519-30	■ mix 30 pcs	55,70 /pc	47,00 /pc	
		LG-519-100	■ mix 100 pcs	49,30 /pc	43,50 /pc	
		LG-519-300	■ mix 300 pcs	44,70 /pc	41,50 /pc	
	<ul style="list-style-type: none"> • Catenacciolo per vetro 10 mm • Locking bolt for glass 10 mm • Feststeller für Glas 10 mm 	LG-520-30	■ mix 30 pcs	58,00 /pc	48,30 /pc	
		LG-520-100	■ mix 100 pcs	52,50 /pc	43,50 /pc	
		LG-520-300	■ mix 300 pcs	47,00 /pc	41,50 /pc	
POMOLO - knob - Knopf						
					FINITURE FINISHES OBERFLÄCHEN	
					CP	
	<ul style="list-style-type: none"> • Singolo • Single 	LG-511-30	■ mix 30 pcs	27,00 /pc		
		LG-511-100	■ mix 100 pcs	22,30 /pc		
		LG-511-300	■ mix 300 pcs	18,30 /pc		
	<ul style="list-style-type: none"> • Doppio • Double • Paar 	LG-512-30	■ mix 30 pcs	39,30 /pc		
		LG-512-100	■ mix 100 pcs	28,00 /pc		
		LG-512-300	■ mix 500 pcs	21,30 /pc		

■
 • Confezioni industriali
 • Industrial packaging
 • Industrieverpackungen

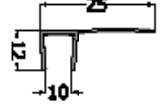
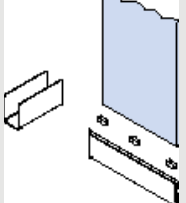
GR*
 • Pezzi forniti smontati per favorire un'eventuale verniciatura
 • Piece supplied not assembled for the lacquering
 • Stück nicht montiert, wegen Lackierung

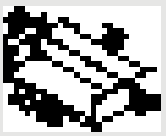
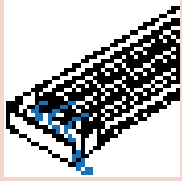
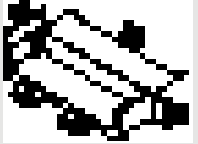
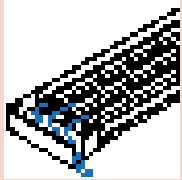
MIX
 • Minimo d'ordine: anche assortiti fra i vari accessori
 • Minimum order: also a combination of various accessories
 • Mindestbestellmenge: auch sortiert nach verschiedenen Zubehören

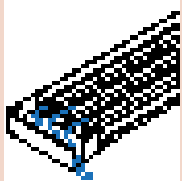
PROD.	DESCRIPTION	ART.	MIS.	Q.TÀ	EURO	EURO
LG-500						
ACCESSORI - accessories - Zubehör						
 L = 550 mt	<ul style="list-style-type: none"> • Setola per binari superiori per vetro 10 mm • Brush seal for track profiles for glass 10 mm • Bürstendichtungen für Laufschieneprofil für Glas 10 mm 	LG-522-550	550 mt	1 pc	1064,30 /pc 1,94 /m	
			550 mt	2 pcs	933,00 /pc 1,70 /m	
			550 mt	■ > 3 pcs	673,50 /pc 1,22 /m	
 L = 550 mt	<ul style="list-style-type: none"> • Setola per montante laterale LG-508 • Brush seal for "U" side profile LG-508 • Bürstendichtungen für "U"-seitliches Profil LG-508 	LG-524-550	550 mt	1 pc	478,70 /pc 0,87 /m	
	<ul style="list-style-type: none"> • Guarnizione per vetro 10 mm • Seal for glass 10 mm • Dichtprofil für Glas 10 mm 	LG-518	2900 mm	■ min 30 pcs	23,50 /pc	
		LG-518-120	2900 mm	■ 120 pcs	20,30 /pc 2436,00 /set	
	<ul style="list-style-type: none"> • "U" trasparenti per incollaggio perpendicolare vetro 10 mm al profilo anta • Transparent "U" support for perpendicular glueing of 10 mm glass to panel profile • Transparenten U-Auflagen für 10 mm Glas zum passgenauen senkrechten einkleben ins Flügelprofil 	ILG-526		■ min 50 pcs	3,50 /pc	
				■ min 200 pcs	2,50 /pc	
	<ul style="list-style-type: none"> • Chiave di manutenzione sgancio ante dal sistema antisollevamento • Maintenance tool to release the panels from the anti-lifting mechanism • Revisionswerkzeug um die Türen aus dem Aushebeschutzsystem zu anheben 	LG-517		1 pc	30,30 /pc	
				1 pc	30,30 /pc	
	<ul style="list-style-type: none"> • Sistema scarico acqua laterale per guida inferiore 3 vie • Side drainage system for 3-ways floor profile • Seitliches Entwässerungssystem für 3-läufige Bodenschiene 	LG-533-30		■ mix 30 pcs	13,50 /pc	
		LG-533-100		■ mix 100 pcs	11,30 /pc	
		LG-533-300		■ mix 300 pcs	9,30 /pc	
	<ul style="list-style-type: none"> • Sistema scarico acqua laterale per guida inferiore 4 vie • Side drainage system for 4-ways floor profile • Seitliches Entwässerungssystem für 4-läufige Bodenschiene 	LG-534-30		■ mix 30 pcs	13,50 /pc	
		LG-534-100		■ mix 100 pcs	11,30 /pc	
		LG-534-300		■ mix 300 pcs	9,30 /pc	
	<ul style="list-style-type: none"> • Sistema scarico acqua laterale per guida inferiore 5 vie • Side drainage system for 5-ways floor profile • Seitliches Entwässerungssystem für 5-läufige Bodenschiene 	LG-535-30		■ mix 30 pcs	13,50 /pc	
		LG-535-100		■ mix 100 pcs	11,30 /pc	
		LG-535-300		■ mix 300 pcs	9,30 /pc	

PROD.	DESCRIPTION	ART.	MIS.	Q.TÀ	EURO	EURO
LG-500					FINITURE FINISHES OBERFLÄCHEN IX	
ACCESSORI - accessories - Zubehör						
	<ul style="list-style-type: none"> • Contropiastra • Strike plate • Schließblech 	LG-516-30		■ mix 30 pcs	17,00 /pc	
		LG-516-100		■ mix 100 pcs	14,70 /pc	
		LG-516-300		■ mix 300 pcs	13,50 /pc	
FINITURE FINISHES OBERFLÄCHEN					AG	GR*
	<p>LG-521 LG-510 not included</p>	LG-521-30		■ mix 30 pcs	108,30 /pc	99,30 /pc
		LG-521-100		■ mix 100 pcs	97,00 /pc	90,50 /pc
		LG-521-300		■ mix 300 pcs	89,30 /pc	81,30 /pc
	<ul style="list-style-type: none"> • Guarnizione per vetro 12 mm • Seal for glass 12 mm • Dichtprofil für Glas 12 mm 	V-040-REG	3000 mm	1 pc	61,50 /pc	

2 RUOTE - wheels - Räder

ESEMPIO DI COSTO AL METRO CON IMBALLI INDUSTRIALI - Example cost per meter in bulk packaging - Beispiel Preis pro Meter mit Industrieverpackung

LG-500 SET 2			Min 16 bars (min 30 carrelli)		Min 80 bars (min 100 carrelli)		Pacchi industriali (min 300 carrelli)	
FINITURE FINISHES OBERFLÄCHEN			AN - BI	GR*	AN - BI	GR*	AN - BI	GR*
LG-528		1 m	TCU /m	TCV /m	TCW /m	TCX /m	TCZ /m	TDA /m
LG-529		1 m	TDB /m	TDC /m	TDD /m	TDE /m	TDF /m	TDG /m
LG-505		1 m	TDH /m	TDI /m	TDJ /m	TDK /m	TDL /m	TDM /m
LG-509		2 pcs	TDN /m	TDO /m	TDP /m	TDQ /m	TDR /m	TDS /m
LG-518		1 pc	TDT /m	TDU /m	TDV /m	TDW /m	TDX /m	TDY /m
LG-522		4 m	TDZ /m	TEA /m	TEB /m	TEC /m	TED /m	TEF /m
TOTALE			 TEG /m	 TEH /m	 TEI /m	 TEJ /m	 TEK /m	 TEL /m





LG-500 SET 3			Min 16 bars (min 30 carrelli)		Min 80 bars (min 100 carrelli)		Pacchi industriali (min 300 carrelli)	
FINITURE FINISHES OBERFLÄCHEN			AN - BI	GR*	AN - BI	GR*	AN - BI	GR*
LG-501		1 m	TEM /m	TEN /m	TEO /m	TEP /m	TEQ /m	TER /m
LG-502		1 m	TES /m	TET /m	TEU /m	TEV /m	TEW /m	TEX /m
LG-505		1 m	TEY /m	TEZ /m	TFA /m	TFB /m	TFC /m	TFD /m
LG-509		2 pcs	TFE /m	TFF /m	TFG /m	TFH /m	TFI /m	TFJ /m
LG-518		1 pc	TFK /m	TFL /m	TFM /m	TFN /m	TFO /m	TFP /m
LG-522		6 m	TFPA /m	TFQ /m	TFR /m	TFS /m	TFT /m	TFU /m
TOTALE			 TFV /m	 TFW /m	 TFX /m	 TFY /m	 TFZ /m	 TGA /m



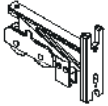

GR*

• Profili forniti grezzi, carrelli LG-509 forniti argento

• xxx



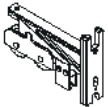

• xxx



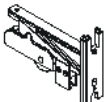

LG-500 SET 4		Min 16 bars (min 30 carrelli)		Min 80 bars (min 100 carrelli)		Pacchi industriali (min 300 carrelli)	
FINITURE FINISHES OBERFLÄCHEN		AN - BI	GR*	AN - BI	GR*	AN - BI	GR*
LG-504	 1 m	TGB /m	TGC /m	TGD /m	TGE /m	TGF /m	TGG /m
LG-506	 1 m	TGH /m	TGI /m	TGJ /m	TGM /m	TGL /m	TGM /m
LG-505	 1 m	TGN /m	TGO /m	TGP /m	TGO /m	TGR /m	TGS /m
LG-509	 2 pcs	TGT /m	TGU /m	TGV /m	TGW /m	TGX /m	TGZ /m
LG-518	 1 pc	THA /m	THB /m	THC /m	THD /m	THE /m	THF /m
LG-522	 8 m	THG /m	THH /m	THI /m	THJ /m	THK /m	THL /m
TOTALE		 THM /m	 THN /m	 THO /m	 THP /m	 THQ /m	 THR /m

LG-500 SET 5		Min 16 bars (min 30 carrelli)		Min 80 bars (min 100 carrelli)		Pacchi industriali (min 300 carrelli)	
FINITURE FINISHES OBERFLÄCHEN		AN - BI	GR*	AN - BI	GR*	AN - BI	GR*
LG-513	 1 m	THS /m	THT /m	THU /m	THV /m	THW /m	THX /m
LG-514	 1 m	THY /m	THZ /m	TIA /m	TIB /m	TIC /m	TID /m
LG-505	 1 m	TIE /m	TIF /m	TIG /m	TIH /m	TII /m	TIL /m
LG-509	 2 pcs	TIJ /m	TIK /m	TILA /m	TIM /m	TIN /m	TIO /m
LG-518	 1 pc	TIP /m	TIQ /m	TIR /m	TIS /m	TIT /m	TIU /m
LG-522	 10 m	TIV /m	TIW /m	TIX /m	TIY /m	TIZ /m	TJA /m
TOTALE		 TJB /m	 TJC /m	 TJD /m	 TJE /m	 TJF /m	 TJG /m

1 RUOTA - wheel - Rad

ESEMPIO DI COSTO AL METRO CON IMBALLI INDUSTRIALI - Example cost per meter in bulk packaging - Beispiel Preis pro Meter mit Industrieverpackung

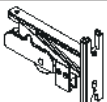
LG-550 SET 2			Min 16 bars (min 30 carrelli)		Min 80 bars (min 100 carrelli)		Pacchi industriali (min 300 carrelli)	
FINITURE FINISHES OBERFLÄCHEN			AN - BI	GR*	AN - BI	GR*	AN - BI	GR*
LG-528		1 m	TJH /m	TJI /m	TJJ /m	TJK /m	TJL /m	TJM /m
LG-529		1 m	TJN /m	TJO /m	TJP /m	TJPA /m	TJR /m	TJS /m
LG-505		1 m	TJT /m	TJU /m	TJV /m	TJW /m	TJX /m	TJY /m
LG-519		2 pcs	TJZ /m	TKA /m	TKB /m	TKC /m	TKD /m	TKE /m
LG-518		1 pc	TKF /m	TKG /m	TKH /m	TKI /m	TKJ /m	TKK /m
LG-522		4 m	TKL /m	TKM /m	TKN /m	TKO /m	TKP /m	TKQ /m
TOTALE			 TKR /m	 TKS /m	 TKT /m	 TKU /m	 TKV /m	 TKW /m





LG-550 SET 3			Min 16 bars (min 30 carrelli)		Min 80 bars (min 100 carrelli)		Pacchi industriali (min 300 carrelli)	
FINITURE FINISHES OBERFLÄCHEN			AN - BI	GR*	AN - BI	GR*	AN - BI	GR*
LG-501		1 m	TKX /m	TKY /m	TKZ /m	TLA /m	TLB /m	TLC /m
LG-502		1 m	TLD /m	TLE /m	TLF /m	TLG /m	TLH /m	TLI /m
LG-505		1 m	TLJ /m	TLK /m	TLL /m	TLM /m	TLN /m	TLO /m
LG-519		2 pcs	TLP /m	TLQ /m	TLR /m	TLS /m	TLT /m	TLU /m
LG-518		1 pc	TLV /m	TLW /m	TLX /m	TLY /m	TLZ /m	TMA /m
LG-522		6 m	TMB /m	TMC /m	TMD /m	TME /m	TMF /m	TMG /m
TOTALE			 TMH /m	 TMI /m	 TMJ /m	21,67 /m	 TML /m	 TMM /m





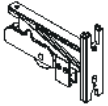

GR*

• Profili forniti grezzi, carrelli LG-519 forniti argento

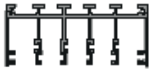
• xxx

• xxx

LG-550 SET 4		Min 16 bars (min 30 carrelli)		Min 80 bars (min 100 carrelli)		Pacchi industriali (min 300 carrelli)	
FINITURE FINISHES OBERFLÄCHEN		AN - BI	GR*	AN - BI	GR*	AN - BI	GR*
LG-504	 1 m	TMN /m	TMO /m	TMP /m	TMQ /m	TMR /m	TMS /m
LG-506	 1 m	TMT /m	TMU /m	TMV /m	TMW /m	TMX /m	TMY /m
LG-505	 1 m	TMZ /m	TNA /m	TNB /m	TNC /m	TND /m	TNE /m
LG-519	 2 pcs	TNF /m	TNG /m	TNH /m	TNI /m	TNJ /m	TNK /m
LG-518	 1 pc	TNL /m	TNM /m	TNN /m	TNO /m	TNP /m	TNQ /m
LG-522	 8 m	TNR /m	TNS /m	TNT /m	TNU /m	TNV /m	TNW /m
TOTALE		 TNX /m	 TNY /m	 TNZ /m	 TOA /m	 TOB /m	 TOC /m

LG-550 SET 5		Min 16 bars (min 30 carrelli)		Min 80 bars (min 100 carrelli)		Pacchi industriali (min 300 carrelli)	
FINITURE FINISHES OBERFLÄCHEN		AN - BI	GR*	AN - BI	GR*	AN - BI	GR*
LG-513	 1 m	TOD /m	TOE /m	TOF /m	TOG /m	TOH /m	TOI /m
LG-514	 1 m	TOJ /m	TOK /m	TOL /m	TOM /m	TON /m	TOO /m
LG-505	 1 m	TOP /m	TOQ /m	TOR /m	TOS /m	TOT /m	TOU /m
LG-519	 2 pcs	TOV /m	TOW /m	TOX /m	TOY /m	TOZ /m	TPA /m
LG-518	 1 pc	TPB /m	TPC /m	TPD /m	TPE /m	TPF /m	TPG /m
LG-522	 10 m	TPH /m	TPI /m	TPJ /m	TPK /m	TPL /m	TPM /m
TOTALE		 TPN /m	 TPO /m	 TPP /m	 TPQ /m	 TPR /m	 TPS /m

LG-200 LOGGIAGLAS

Scorrevole telescopico | Telescopic sliding system | Teleskop SchiebeTürsystem

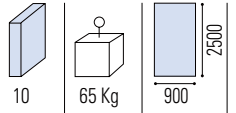

C.354

- Sistema telescopico per ante a trascinamento
- System for telescopic sliding doors
- Teleskopisches SchiebeTürsystem

- Fino ad esaurimento scorte. Contattare ufficio per disponibilità prima di effettuare l'ordine.
 - Article to be discontinued. Available to be checked with sales office.
 - Auslaufartikel Lieferbar solange der vorrat reicht. Die Verfügbarkeit ist mit dem Verkaufsbüro abzustimmen.

**FINE SERIE
 END OF SERIES
 AUSLAUFMODELL**

LG-200 SET 2 DX-SX	AN - RAL 9010
	€ 1007,00

2 ante | panels LB = 2800 mm

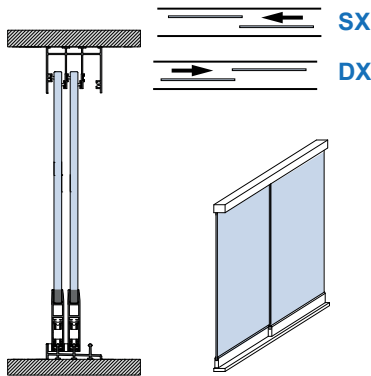

LG-200 C1 SET 2 DX-SX	AN - RAL 9010
	€ 1278,50

2 ante | panels LB = 2800 mm

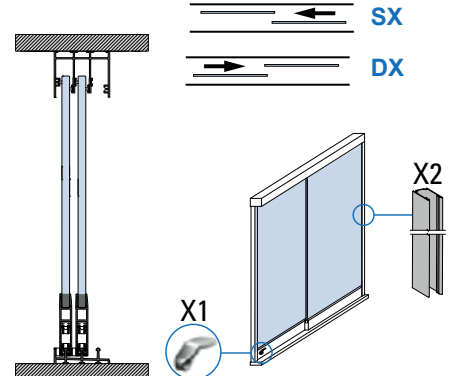

LG-200 C2 SET 2 DX-SX	AN - RAL 9010
	€ 1360,00

2 ante | panels LB = 2800 mm

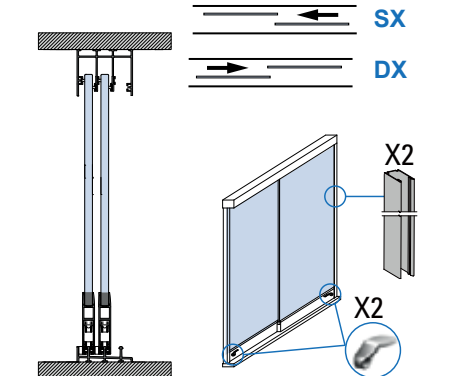

LG-200 SET 3 DX-SX	AN - RAL 9010
	€ 1196,00

3 ante | panels LB = 2800 mm

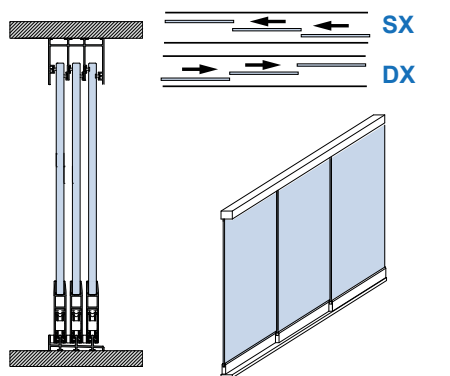

LG-200 C1 SET 3 DX-SX	AN - RAL 9010
	€ 1460,70

3 ante | panels LB = 2800 mm

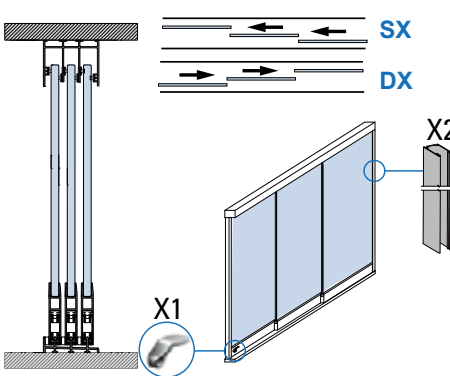

LG-200 C2 SET 3 DX-SX	AN - RAL 9010
	€ 1521,70

3 ante | panels LB = 2800 mm

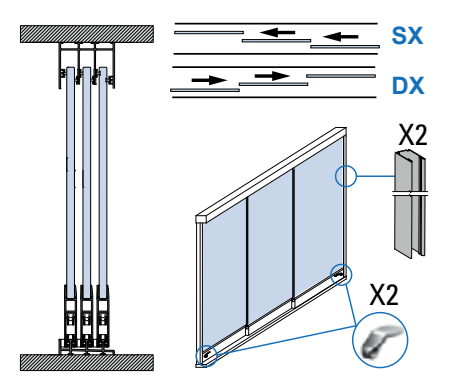

C1 = con 1 catenacciolo | with 1 locking bolt | mit 1 Feststellriegel
C2 = con 2 catenaccioli 1 | with 2 locking bolts | mit 2 Feststellriegel

- Specificare se per apertura a destra o a sinistra
 • Please specify always opening direction
 • Bitte immer Öffnungsrichtung angeben

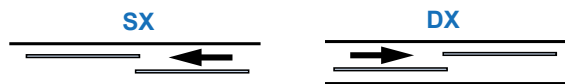

- Tagliato dal cliente
 • Cut by installer
 • Schnitt bauseitig

- Trasporto fuori standard. Vedi condizioni di vendita
 • Non-standard trasport. See sales conditions
 • Sondertransport. Siehe AGB

TAGLIO-LG-SET

- Il costo per n° 3 tagli dei 3 profili componenti il set Loggiaglas è di € 62,00 a set
- The cost for 3 cuts of the 3 profiles composing the Loggiaglas set is € 62,00 per set
- Der Preis für 3 Schnitte der Profile, die zum Set Loggiaglas gehören, beträgt € 62,00 pro Set

- Fino ad esaurimento scorte. Contattare ufficio per disponibilità prima di effettuare l'ordine.
 - Article to be discontinued. Available to be checked with sales office.
 - Auslaufartikel Lieferbar solange der vorrat reicht. Die Verfügbarkeit ist mit dem Verkaufsbüro abzustimmen.

**FINE SERIE
 END OF SERIES
 AUSLAUFMODELL**

LG-200 SET 4 DX-SX	AN - RAL 9010
	€ 1829,00
4 ante panels	LB = 4500 mm

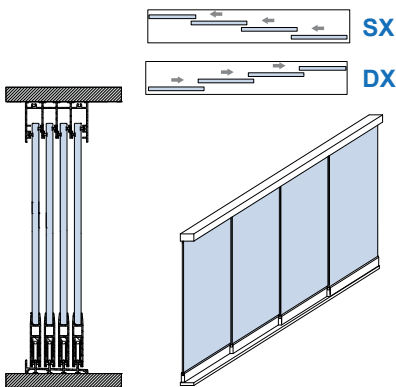

LG-200 C1 SET 4 DX-SX	AN - RAL 9010
	€ 2091,50
4 ante panels	LB = 4500 mm

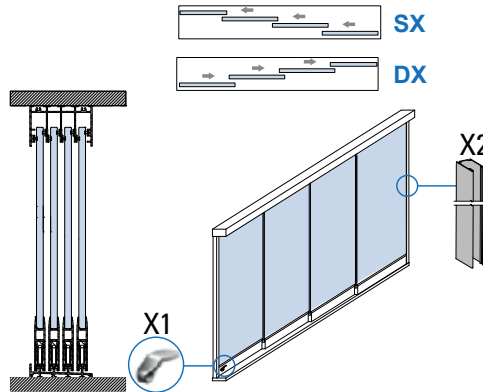

LG-200 C2 SET 4 DX-SX	AN - RAL 9010
	€ 2152,30
4 ante panels	LB = 4500 mm

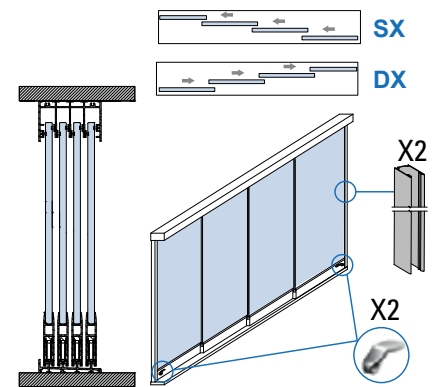

LG-200 SET 5 DX-SX	AN - RAL 9010
	€ 2413,70
5 ante panels	LB = 5800 mm

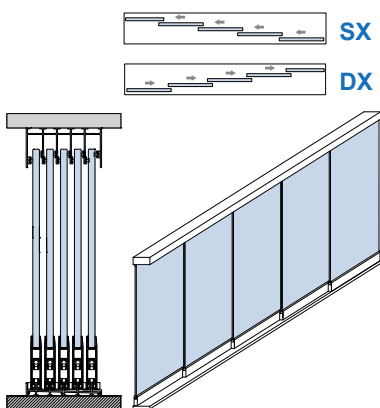

LG-200 C1 SET 5 DX-SX	AN - RAL 9010
	€ 2656,70
5 ante panels	LB = 5800 mm

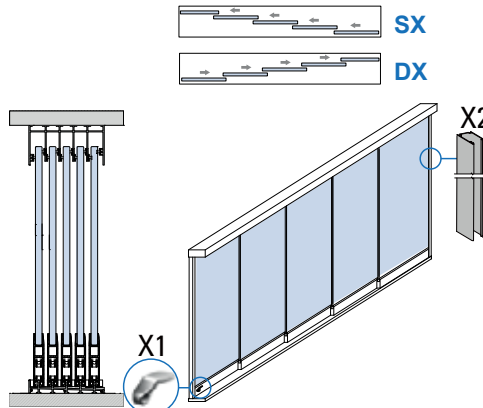

LG-200 C2 SET 5 DX-SX	AN - RAL 9010
	€ 2716,30
5 ante panels	LB = 5800 mm

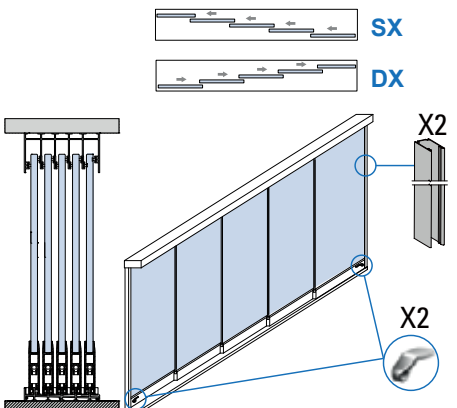

C1 = con 1 catenacciolo | with 1 locking bolt | mit 1 Feststellriegel
C2 = con 2 catenaccioli | with 2 locking bolts | mit 2 Feststellriegel



- Specificare se per apertura a destra o a sinistra
- Please specify always opening direction
- Bitte immer Öffnungsrichtung angeben

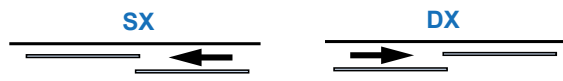

do-it-yourself

- Binario superiore, profili anta e canalina forniti in misura FIX da tagliare cliente secondo schema [MY METALGLAS](#)
- Top track profile, panel profiles and floor profile supplied in FIX length cut by installer according to [MY METALGLAS](#) configurator
- Laufschienenprofil, Flügelprofile und Bodenschiene in Fixlängen schnitt bauseitig gemäss Konfigurator [MY METALGLAS](#)

LG-210 LOGGIAGLAS

Scorrevole telescopico | Telescopic sliding system | Teleskop SchiebeTürsystem

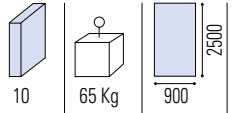

C.355

- Sistema telescopico per ante a trascinamento, con guida incassata
- System for telescopic sliding doors, with recessed floor profile
- Teleskopisches SchiebeTürsystem, mit versenkter Bodenschiene

**FINE SERIE
END OF SERIES
AUSLAUFMODELL**

- Fino ad esaurimento scorte. Contattare ufficio per disponibilità prima di effettuare l'ordine.
- Article to be discontinued. Available to be checked with sales office.
- Auslaufartikel Lieferbar solange der vorrat reicht. Die Verfügbarkeit ist mit dem Verkaufsbüro abzustimmen.

LG-210 SET 2 DX-SX	AN - RAL 9010
	€ 1026,50

2 ante | panels LB = 2800 mm

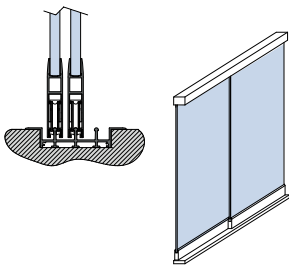

LG-210 C1 SET 2 DX-SX	AN - RAL 9010
	€ 1283,30

2 ante | panels LB = 2800 mm

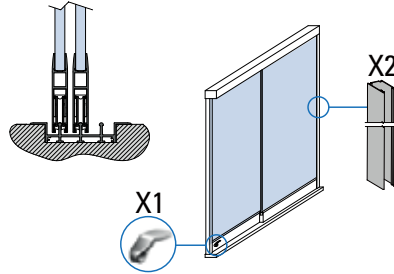
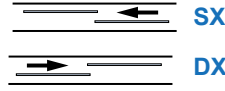

LG-210 C2 SET 2 DX-SX	AN - RAL 9010
	€ 1301,70

2 ante | panels LB = 2800 mm

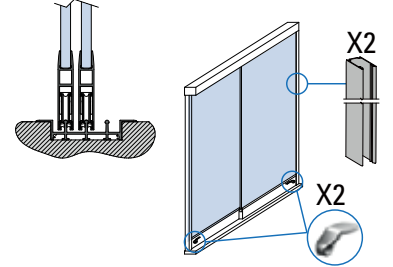
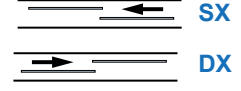

LG-210 SET 3 DX-SX	AN - RAL 9010
	€ 1216,70

3 ante | panels LB = 2800 mm

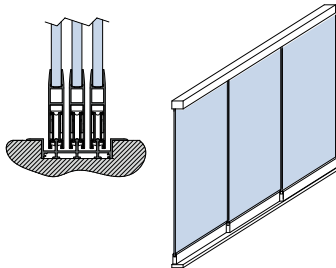
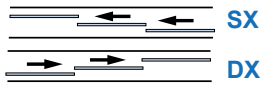

LG-210 C1 SET 3 DX-SX	AN - RAL 9010
	€ 1481,70

3 ante | panels LB = 2800 mm

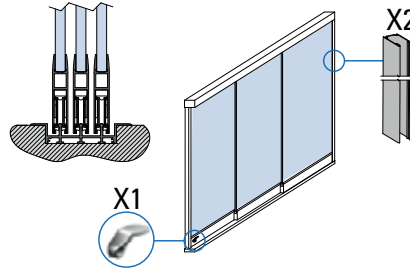
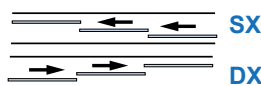

LG-210 C2 SET 3 DX-SX	AN - RAL 9010
	€ 1542,30

3 ante | panels LB = 2800 mm

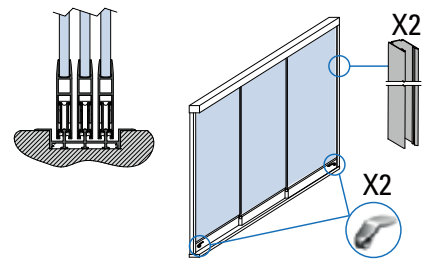
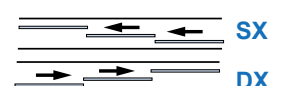

C1 = con 1 catenacciolo | with 1 locking bolt | mit 1 Feststellriegel
C2 = con 2 catenaccioli 1 | with 2 locking bolts | mit 2 Feststellriegel



- Specificare se per apertura a destra o a sinistra
- Please specify always opening direction
- Bitte immer Öffnungsrichtung angeben

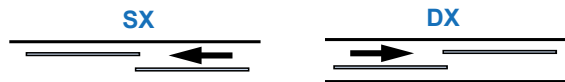

- Tagliato dal cliente
- Cut by installer
- Schnitt bauseitig



- Trasporto fuori standard. Vedi condizioni di vendita
- Non-standard trasport. See sales conditions
- Sondertransport. Siehe AGB



TAGLIO-LG-SET

- Il costo per n° 3 tagli dei 3 profili componenti il set Loggiaglas è di € 62,00 a set
- The cost for 3 cuts of the 3 profiles composing the Loggiaglas set is € 62,00 per set
- Der Preis für 3 Schnitte der Profile, die zum Set Loggiaglas gehören, beträgt € 62,00 pro Set

- Fino ad esaurimento scorte. Contattare ufficio per disponibilità prima di effettuare l'ordine.
 - Article to be discontinued. Available to be checked with sales office.
 - Auslaufartikel Lieferbar solange der vorrat reicht. Die Verfügbarkeit ist mit dem Verkaufsbüro abzustimmen.

**FINE SERIE
 END OF SERIES
 AUSLAUFMODELL**

LG-210 SET 4 DX-SX	AN - RAL 9010
	€ 1869,00

4 ante | panels LB = 4500 mm

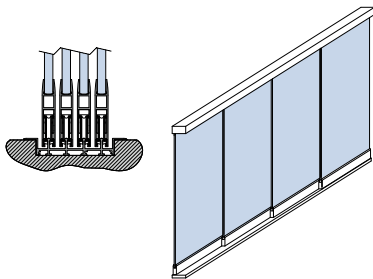
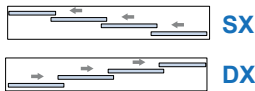

LG-210 C1 SET 4 DX-SX	AN - RAL 9010
	€ 2130,30

4 ante | panels LB = 4500 mm

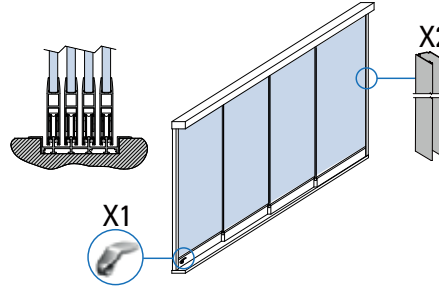
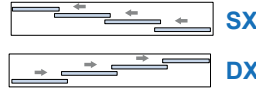

LG-210 C2 SET 4 DX-SX	AN - RAL 9010
	€ 2189,70

4 ante | panels LB = 4500 mm

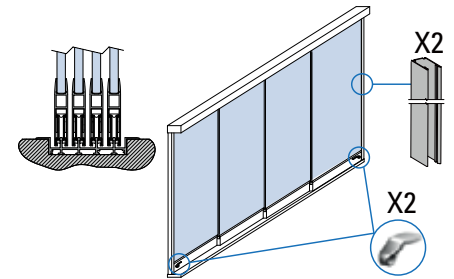
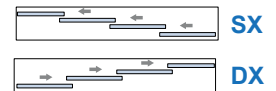

LG-210 SET 5 DX-SX	AN - RAL 9010
	€ 2426,00

5 ante | panels LB = 5800 mm

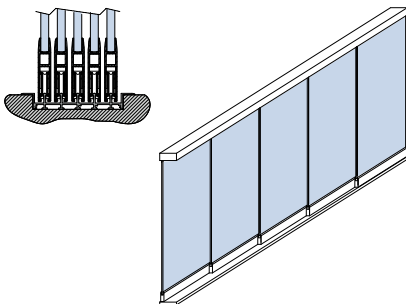
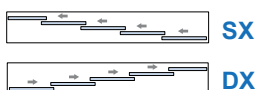

LG-210 C1 SET 5 DX-SX	AN - RAL 9010
	€ 2668,30

5 ante | panels LB = 5800 mm

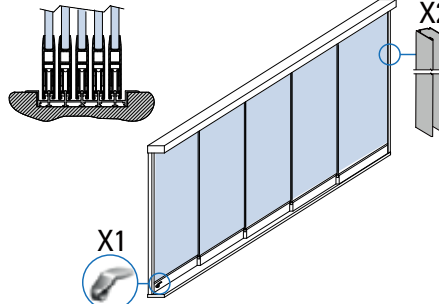
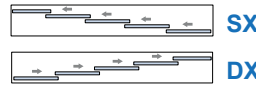

LG-210 C2 SET 5 DX-SX	AN - RAL 9010
	€ 2729,00

5 ante | panels LB = 5800 mm

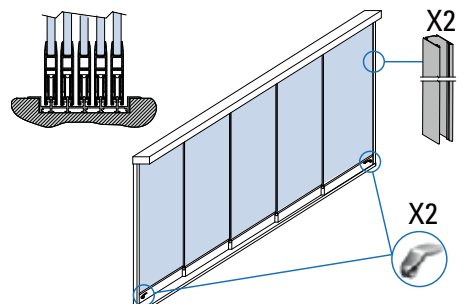
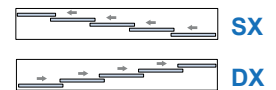

C1 = con 1 catenacciolo | with 1 locking bolt | mit 1 Feststellriegel
C2 = con 2 catenaccioli 1 | with 2 locking bolts | mit 2 Feststellriegel



- Specificare se per apertura a destra o a sinistra
- Please specify always opening direction
- Bitte immer Öffnungsrichtung angeben

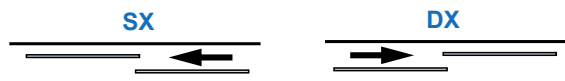

do-it-yourself

- Binario superiore, profili anta e canalina forniti in misura FIX da tagliare cliente secondo schema [MY METALGLAS](#)
- Top track profile, panel profiles and floor profile supplied in FIX length cut by installer according to [MY METALGLAS](#) configurator
- Laufschienenprofil, Flügelprofile und Bodenschiene in Fixlängen schnitt bauseitig gemäss Konfigurator [MY METALGLAS](#)

POS.	PROD.	ART.	MIS.	Q.TÀ	FIN.	EURO	FIN.	EURO
LG-200 LOGGIAGLAS COMPONENTI / COMPONENTS / EINZELTEILE								
C.356		LG-201	2800 mm	1 pc	AN	331,50 /pc	RAL 9010	331,50 /pc
			5800 mm	1 pc	AN	615,00 /pc	RAL 9010	615,00 /pc
		LG-201 MIS	2800 → 5800 mm	1 pc	AN	641,30 /pc	RAL 9010	641,30 /pc
C.357		LG-206	4500 mm	1 pc	AN	551,70 /pc	RAL 9010	551,70 /pc
C.358		LG-203	5800 mm	1 pc	AN	818,70 /pc	RAL 9010	818,70 /pc
		LG-203 MIS	2800 → 5800 mm	1 pc	AN	837,00 /pc	RAL 9010	837,00 /pc
C.359		LG-202	2800 mm	1 pc	AN	171,00 /pc	RAL 9010	171,00 /pc
			5800 mm	1 pc	AN	296,30 /pc	RAL 9010	296,30 /pc
		LG-202 MIS	2800 → 5800 mm	1 pc	AN	322,30 /pc	RAL 9010	322,30 /pc
C.360		LG-213	2800 mm	1 pc	AN	192,00 /pc	RAL 9010	192,00 /pc
			5800 mm	1 pc	AN	337,50 /pc	RAL 9010	337,50 /pc
		LG-213 MIS	2800 → 5800 mm	1 pc	AN	364,00 /pc	RAL 9010	364,00 /pc
C.361		LG-207	4500 mm	1 pc	AN	259,50 /pc	RAL 9010	259,50 /pc
C.362		LG-214	4500 mm	1 pc	AN	298,50 /pc	RAL 9010	298,50 /pc
C.363		LG-204	5800 mm	1 pc	AN	389,30 /pc	RAL 9010	389,30 /pc
		LG-204 MIS	2800 → 5800 mm	1 pc	AN	416,30 /pc	RAL 9010	416,30 /pc
C.364		LG-215	5800 mm	1 pc	AN	425,70 /pc	RAL 9010	425,70 /pc
		LG-215 MIS	2800 → 5800 mm	1 pc	AN	452,00 /pc	RAL 9010	452,00 /pc
C.365		LG-205-4,5	4500 mm	1 pc	AN	/pc	RAL 9010	/pc
		LG-205	5800 mm	1 pc	AN	283,50 /pc	RAL 9010	283,50 /pc
		LG-205 MIS	2800 → 5800 mm	1 pc	AN	311,00 /pc	RAL 9010	311,00 /pc
C.366		LG-208	2900 mm	1 pc	AN	144,70 /pc	RAL 9010	144,70 /pc

FINE SERIE
END OF SERIES
AUSLAUFMODELL

- Fino ad esaurimento scorte. Contattare ufficio per disponibilità prima di effettuare l'ordine.
- Article to be discontinued. Available to be checked with sales office.
- Auslaufartikel Lieferbar solange der vorrat reicht. Die Verfügbarkeit ist mit dem Verkaufsbüro abzustimmen.



- Tagliato dal cliente
- Cut by installer
- Schnitt bauseitig



- Tagliato a misura del cliente
- Custom length
- Nach Mass geschnitten



- Minimo ordine quantità indicata
- Minimum order indicated quantity
- Mindestbestellmenge angeführten Menge



- Trasporto fuori standard. Vedi condizioni di vendita
- Non-standard trasport. See sales conditions
- Sondertransport. Siehe AGB

POS.	PROD.	ART.	MIS.	Q.TÀ	FIN.	EURO	FIN.	EURO
LG-200 LOGGIAGLAS COMPONENTI / COMPONENTS / EINZELTEILE								
C.367		LG-209-DX		1 pc	AN	86,00 /pc	RAL 9010	86,00 /pc
C.368		LG-209-SX		1 pc	AN	86,00 /pc	RAL 9010	86,00 /pc
C.369		LG-210		1 pc	AN	86,00 /pc	RAL 9010	86,00 /pc
C.370		LG-211 • Single locking bolt		1 pc	AN	78,50 /pc		
C.371		LG-212 • Double locking bolt		1 pc	AN	108,30 /pc		
C.372		LG-217 • Locking bolt for corner solutions		1 pc	AN	188,30 /pc		
C.373		LG-GUARN	2900 mm	1 pc		72,50 /pc		
		LG-GUARN-MIX	2900 mm	min 10 pcs		47,30 /pc		
C.374		V-563 • Strike plate for locks V-574 / V-564 with "U" side profile LG-208		1 pc	IX	29,50 /pc		
C.375		V-564		1 pc	CP	143,30 /pc		
C.376		V-574		1 pc	CP	137,30 /pc		
C.377		C-010		1 pc	CR	28,00 /pc		



- Specificare se per apertura a destra o a sinistra
- Please specify always opening direction
- Bitte immer Öffnungsrichtung angeben

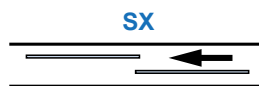

do-it-yourself

- Binario superiore, profili anta e canalina forniti in misura FIX da tagliare cliente secondo schema [MY METALGLAS](#)
- Top track profile, panel profiles and floor profile supplied in FIX length cut by installer according to [MY METALGLAS](#) configurator
- Laufschienenprofil, Flügelprofile und Bodenschiene in Fixlängen schnitt bauseitig gemäss Konfigurator [MY METALGLAS](#)

LG-100 LOGGIAGLAS

Scorrevole telescopico | Telescopic sliding system | Teleskop SchiebeTürsystem

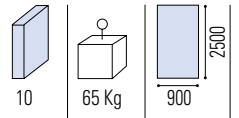

- Sistema telescopico per ante a trascinamento
- System for telescopic sliding doors
- Teleskopisches SchiebeTürsystem

**FINE SERIE
END OF SERIES
AUSLAUFMODELL**

- Fino ad esaurimento scorte. Contattare ufficio per disponibilità prima di effettuare l'ordine.
- Article to be discontinued. Available to be checked with sales office.
- Auslaufartikel Lieferbar solange der vorrat reicht. Die Verfügbarkeit ist mit dem Verkaufsbüro abzustimmen.

LG-100 SET 2 DX-SX

AN

€ 1004,50

2 ante | panels

LB = 2950 mm

LG-100 SET 3 DX-SX

AN

€ 1810,00

3 ante | panels

LB = 5900 mm

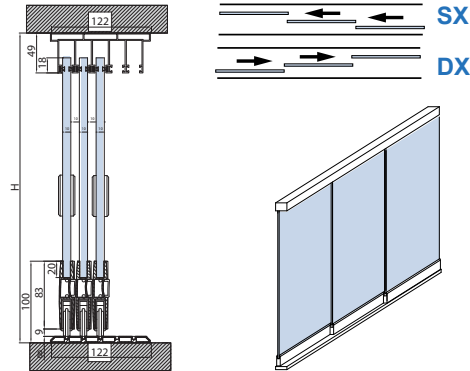
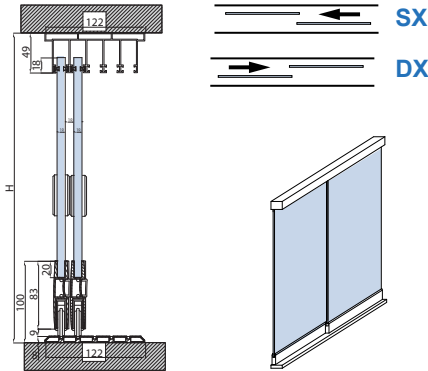

LG-100 SET 4 DX-SX

AN

€ 2001,00

4 ante | panels

LB = 5900 mm

LG-100 SET 5 DX-SX

AN

€ 2259,00

5 ante | panels

LB = 5900 mm

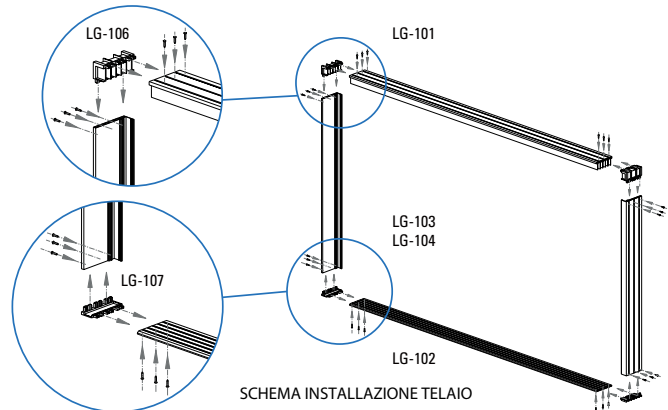
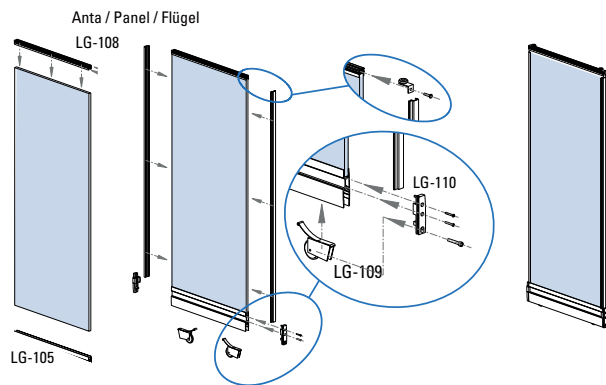
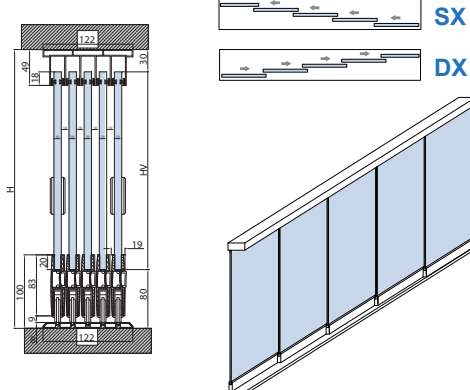
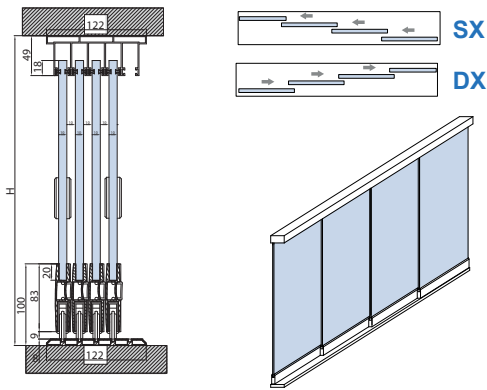

- Tagliato dal cliente
- Cut by installer
- Schnitt bauseitig

- Trasporto fuori standard. Vedi condizioni di vendita
- Non-standard transport. See sales conditions
- Sondertransport. Siehe AGB

- Specificare se per apertura a destra o a sinistra
- Please specify always opening direction
- Bitte immer Öffnungsrichtung angeben

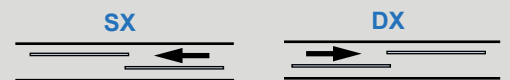

POS.	PROD.	ART.	MIS.	Q.TÀ	FIN.	EURO	FIN.	EURO
LG-100 LOGGIAGLAS COMPONENTI / COMPONENTS / EINZELTEILE								
		LG-101/LG-102	5900 mm	1 pc	AN	1054,30 /pc		
		LG-103	3000 mm	1 pc	AN	244,70 /pc		
		LG-104	3000 mm	1 pc	AN	132,50 /pc		
		LG-105	5900 mm	1 pc	AN	375,00 /pc		
		LG-108	2500 mm	1 pc	AN	39,70 /pc		
		LG-109		2 pcs		84,30 /set		
		LG-110 DX		2 pcs		74,00 /set		
		LG-110 SX		2 pcs		74,00 /set		
		LG-106		2 pcs		62,00 /set		
		LG-107		2 pcs		62,00 /set		
		LG-111		1 pc		135,30 /pc		

do-it-yourself

- Binario superiore, profili anta e canalina forniti in misura FIX da tagliare cliente secondo schema [MY METALGLAS](#)
- Top track profile, panel profiles and floor profile supplied in FIX length cut by installer according to [MY METALGLAS](#) configurator
- Laufschienenprofil, Flügelprofile und Bodenschiene in Fixlängen schnitt bauseitig gemäss Konfigurator [MY METALGLAS](#)

GUIDA TECNICA PER LA SCELTA DEL VOSTRO SISTEMA
TECHNICAL GUIDE FOR THE CHOICE OF YOUR SYSTEM
AUSWAHL VON DUSCHKABINEN NACH VORHANDENEN KRITERIEN

PROFILI PER VETRI FISSI
PROFILES FOR FIXED PANELS
PROFIE FÜR FESTVERGLASUNGEN



PROFILI A SCATTO
CLIP-ON PROFILES
KLIPSPROFIE
P-065 | P-01 | P-02 P-058 | P-059 | P-050 | P-055

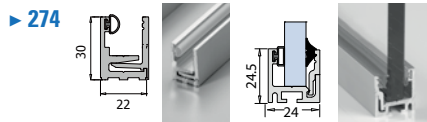

CANALINE "U" IN ALLUMINIO
U PROFILES IN ALUMINIUM
U-PROFILE AUS ALUMINIUM



CANALINE IN ACCIAIO
"U" PROFILES IN INOX
"U" PROFILE AUS INOX



CANALINE "U" CON BORDO RIPIEGATO
"U" PROFILES WITH FOLDED EDGE
"U" PROFILE MIT ABGERUNDET



CANALINE CON ALETTA
U PROFILES WITH PLATE
U-PROFILE MIT PLATTE



ANGOLARI
L PROFILES
L PROFILE



PARETI DIVISORIE CON TRATTA FISSA E STIPIE COORDINATI
PARTITION WALLS WITH COORDINATED FRAMES
TRENNWÄNDE MIT KOORDINIERTEN ZARGEN



EASY PARETE
MONOVETRO



DUAL GLASS
DOPPIO VETRO

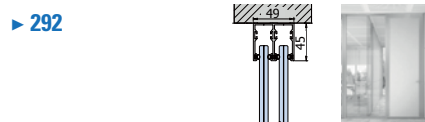

TP-010

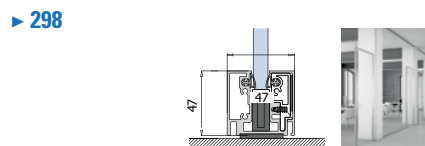

PPS EVOLUTION
MINI SOFT CLOSE



PROFILI IN POLICARBONATO
POLYCARBONATE PROFILES
POLYCARBONATPROFILE

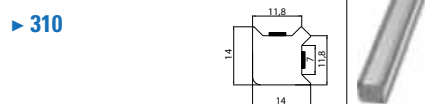

STIPITI SU VETRO
ALUMINIUM FRAMES WITH FIXED SIDE PANELS
ALUZARGEN MIT SEITENTEILEN



TP-201
STIPIE EASY PARETE

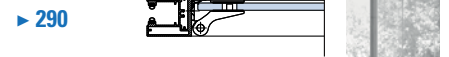

TP-401
STIPIE DUAL GLASS



TP-100

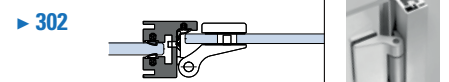

P-030-V

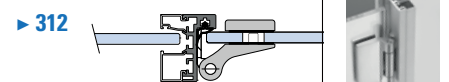

P-080-V

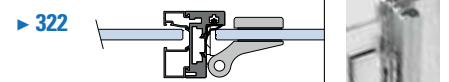

P-085-V

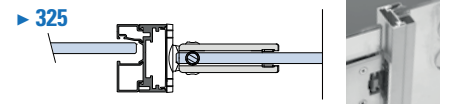

TP-110

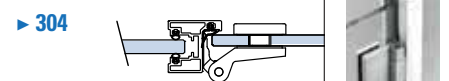

STIPITI SU MURO
ALUMINIUM FRAMES
ALUZARGEN



P-010

▶ 315

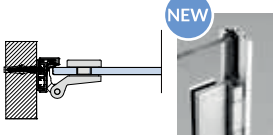

NEW

P-030

▶ 312

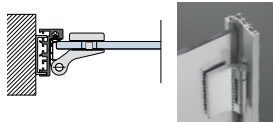

P-080-SL

▶ 322

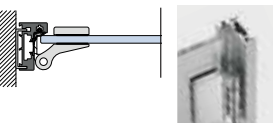

P-040

▶ 317

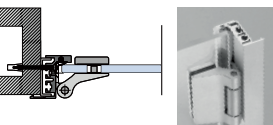

P-085

▶ 325

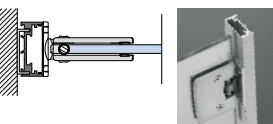

TP-300 IMBOTTE

▶ 319



TP-250

▶ 321



STIPITI RASOMURO E ANTE IN ALLUMINIO
ALIGNED WITH THE WALL FRAMES
AND DOORS WITH ALUMINIUM PANEL
WANDBÜNDIGE ALUZARGE
UND ALUMINIUM FLÜGELRAHMEN



P0-100

▶ 332



P0-200

▶ 330



P-060

▶ 339

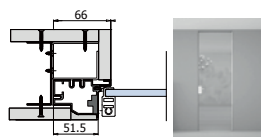

P-070

▶ 340

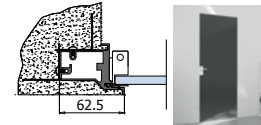

BRIXIA P0-290

▶ 335

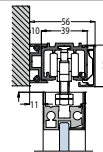

ANTE A SCOMPARSA
FLUSH SLIDING DOORS
SCHIEBETÜREN IN DER WAND LAUFEND

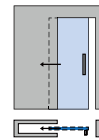

TS-04

▶ 328

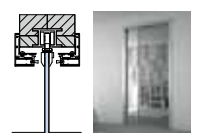

V-1664, TS-03

▶ 329

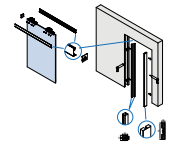

POS.	PROD.	ART.	MIS.	Q.TÀ	FIN.	EURO	FIN.	EURO
<p>PROFILI A SCATTO PER VETRI FISSI CLIP-ON PROFILES FOR FIXED PANELS / KLIPSPROFIE FÜR FESTVERGLASUNGEN</p>								
<p>P-065 ▶ INDOOR 14</p>								
D. 01		P-065-3	3000 mm	1 pc	AN	140,70 /pc		
		P-065-3-MIX	3000 mm	min 3 pc	AN	123,70 /pc		
		P-065-6-MIX	6000 mm	min 3 pc	AN	192,00 /pc		
		MIX	<ul style="list-style-type: none"> • Minimo ordine 3 pezzi, anche assortiti, fra i vari modelli della stessa misura • Minimum order 3 pcs also for combinations of various profiles of equal length • Mindestbestellmenge 3 Stück, auch sortiert nach verschiedenen Profilen und Dichtungen 					
D. 02		SECTOR M	IP-065-PROF	3000 mm	8 pcs	AN	61,50 /pc 20,50 /mtl	GR 54,30 /pc 18,10 /mtl
			6000 mm	4 pcs	AN	115,00 /pc 19,17 /mtl	GR 100,70 /pc 16,78 /mtl	
D. 03		SECTOR M	IP-065-CART	3000 mm	16 pcs	AN	29,00 /pc 9,67 /mtl	GR 22,00 /pc 7,33 /mtl
			6000 mm	8 pcs	AN	50,70 /pc 8,45 /mtl	GR 36,30 /pc 6,05 /mtl	
		<p>MINIMO D'ORDINE: 8 profili da 6 mt o 16 profili da 3 mt (o multipli), anche assortiti tra i vari modelli, dello stesso settore di magazzino indicato in tabella (SECTOR).</p> <p>MINIMUM ORDER: No. 8 - 6 m profiles, or No. 16 - 3 m profiles, or No. 24 - 2 m profiles (or multiples), also in combination of different models, as long as they belong to the same warehouse sector indicated in the table (SECTOR).</p> <p>MINDESTBESTELLMENGE: 8 Profile mit 6 m oder 16 Profile mit 3 m (nur als Vielfaches), auch sortiert nach den verschiedenen Modellen, aber aus demselben Lagerort, der in der Tabelle angeführt ist (SECTOR).</p>						
D. 04		B-146	3000 mm	1 pc		32,00 /pc		
		IB-146	3000 mm	min 24 pcs		10,00 /pc		
		IB-146-CF140	3000 mm	140 pcs		7,74 /pc 1083,50 /set		
D. 05		P-065-TA-CF4	Tappo Endcap Endkappe	4 pcs	AN	10,08 /pc 40,30 /set		

- Confezioni industriali
- Industrial packaging
- Industrieverpackungen

- Confezioni profili con quantità fissa, disponibili solo in multipli della quantità indicata
- Packs of profiles with fixed quantity, available only in multiples of the indicated quantity
- Profilpackungen mit fixer Menge sind nur als Vielfaches der angeführten Menge erhältlich

CF

- Prezzi speciali per l'acquisto delle quantità minime indicate (CF) dell'articolo.
- NB: eventuali riordini o aggiunte per completamenti se di quantità inferiore alla minima, saranno fatturati al prezzo normale
- Special prices for the purchase of the minimum quantities indicated (CF) of the article.
- Note Well: any reorders or additions for completions of quantity less than the minimum will be invoiced at the normal price.
- Artikel mit Sonderpreisen bei Mindestabnahmemengen sind mit (CF) gekennzeichnet.
- Nachbestellungen oder Ergänzungen unter der Mindestabnahmemenge werden mit dem Normalpreis verrechnet.

POS.	PROD.	ART.	MIS.	Q.TÀ	FIN.	EURO	FIN.	EURO	
D. 06	P-065 P-050	VP-016	VP-017	VP-018	VP-019	VP-018			
		VP-016 5 mm	VP-016 5 mm	VP-017 4 mm	VP-017 4 mm	VP-018 3 mm	VP-018 3 mm	VP-019 2 mm	VP-019 2 mm
	5 mm	VP-016			20 mtl		3,14 /mtl 62,70 /pc		
		VP-016-CF150			■ 150 mtl		2,75 /mtl 412,00 /pc		
	4 mm	VP-017			20 mtl		2,27 /mtl 45,30 /pc		
		VP-017-CF250			■ 250 mtl		1,81 /mtl 453,50 /pc		
	3 mm	VP-018			20 mtl		1,93 /mtl 38,50 /pc		
		VP-018-CF300			■ 300 mtl		1,49 /mtl 447,50 /pc		
	2 mm	VP-019			20 mtl		1,93 /mtl 38,50 /pc		
		VP-019-CF400			■ 400 mtl		1,49 /mtl 596,30 /pc		
	D. 07	P-050 FINE SERIE END OF SERIES AUSLAUFMODELL	P-050-3-MIX	3000 mm	min 3 pcs	AN	47,30 /pc	Prezzi netti Net prices Nettopreise	
			P-050-6-MIX	6000 mm	min 3 pcs	AN	73,50 /pc	Prezzi netti Net prices Nettopreise	
MIX			<ul style="list-style-type: none"> • Minimo ordine 3 pezzi, anche assortiti, fra i vari modelli della stessa misura • Minimum order 3 pcs also for combinations of various profiles of equal length • Mindestbestellmenge 3 Stück, auch sortiert nach verschiedenen Profilen und Dichtungen 						
D. 08		P-052	Squadretta collegamento verticale Vertical connecting bracket Eckverbinder			11,70 /pc			
D. 09		P-051	Tappo Endcap Endkappe	1 pcs	AN	11,30 /pc			

MIX

- Minimo ordine quantità indicata, anche assortiti
- Minimum order indicated quantity, also a mixture
- Mindestbestellmenge angeführten Menge, sortiert



- Trasporto fuori standard. Vedi condizioni di vendita
- Non-standard transport. See sales conditions
- Sondertransport. Siehe AGB

POS.	PROD.	ART.	MIS.	Q.TÀ	FIN.	EURO	FIN.	EURO	
P-058		▶ INDOOR 15							
D. 10		P-058-3	3000 mm	1 pc	AN	161,50 /pc	IXE	191,30 /pc	
					NO	194,00 /pc	XO	232,00 /pc	
					BI-BC-BS	254,00 pc			
		P-058-3-MIX	3000 mm	■ min 3 pcs	AN	122,00 /pc	IXE	156,50 /pc	
					NO	146,30 /pc	XO	208,00 /pc	
					BI-BC-BS	226,50 pc			
		P-058-6-MIX	6000 mm	■ min 3 pcs	AN	222,00 /pc	IXE	291,50 /pc	
					NO	266,50 /pc	XO	350,00 /pc	
					BI-BC-BS	382,00 pc			
		MIX	<ul style="list-style-type: none"> • Minimo ordine 3 pezzi, anche assortiti, fra i vari modelli della stessa misura • Minimum order 3 pcs also for combinations of various profiles of equal length • Mindestbestellmenge 3 Stück, auch sortiert nach verschiedenen Profilen und Dichtungen 						
D. 11		SECTOR M	IP-058-PROF ⚠	3000 mm	■ 8 pcs	AN	72,30 /pc 24,10 /mtl	GR	64,70 /pc 21,57 /mtl
				6000 mm	■ 4 pcs	AN	136,30 /pc 22,72 /mtl	GR	122,00 /pc 20,33 /mtl
D. 12		SECTOR M	IP-058-CART ⚠	3000 mm	■ 16 pcs	AN	36,30 /pc 12,10 /mtl	GR	29,00 /pc 9,67 /mtl
				6000 mm	■ 8 pcs	AN	64,70 /pc 10,78 /mtl	GR	50,70 /pc 8,45 /mtl
		<p>MINIMO D'ORDINE: 8 profili da 6 mt o 16 profili da 3 mt (o multipli ⚠), anche assortiti tra i vari modelli, dello stesso settore di magazzino indicato in tabella (SECTOR).</p> <p>MINIMUM ORDER: No. 8 - 6 m profiles, or No. 16 - 3 m profiles, or No. 24 - 2 m profiles (or multiples ⚠), also in combination of different models, as long as they belong to the same warehouse sector indicated in the table (SECTOR).</p> <p>MINDESTBESTELLMENGE: 8 Profile mit 6 m oder 16 Profile mit 3 m (nur als Vielfaches ⚠), auch sortiert nach den verschiedenen Modellen, aber aus demselben Lagerort, der in der Tabelle angeführt ist (SECTOR).</p>							
D. 13		B-146	3000 mm	1 pc		32,00 /pc			
		IB-146	3000 mm	■ min 24 pcs		10,00 /pc			
		IB-146-CF140	3000 mm	■ 140 pcs		7,74 /pc 1083,50 /set			
D. 14		P-068-CF4	Tappo Endcap Endkappe	4 pc	AN	10,63 /pc 42,50 /set	IXE	14,33 /pc 57,30 /set	

- Confezioni industriali
- Industrial packaging
- Industrieverpackungen

- ⚠ Confezioni profili con quantità fissa, disponibili solo in multipli della quantità indicata
- Packs of profiles with fixed quantity, available only in multiples of the indicated quantity
- Profilpackungen mit fixer Menge sind nur als Vielfaches der angeführten Menge erhältlich

CF

- Prezzi speciali per l'acquisto delle quantità minime indicate (CF) dell'articolo.
- NB: eventuali riordini o aggiunte per completamenti se di quantità inferiore alla minima, saranno fatturati al prezzo normale
- Special prices for the purchase of the minimum quantities indicated (CF) of the article.
- Note Well: any reorders or additions for completions of quantity less than the minimum will be invoiced at the normal price.
- Artikel mit Sonderpreisen bei Mindestabnahmemengen sind mit (CF) gekennzeichnet.
- Nachbestellungen oder Ergänzungen unter der Mindestabnahmemenge werden mit dem Normalpreis verrechnet.

POS.	PROD.	ART.	MIS.	Q.TÀ	FIN.	EURO	FIN.	EURO
D. 15								
	5 mm	VP-016		20 mtl		3,14 /mtl 62,70 /pc		
		VP-016-CF150		■ 150 mtl		2,75 /mtl 412,00 /pc		
	4 mm	VP-017		20 mtl		2,27 /mtl 45,30 /pc		
		VP-017-CF250		■ 250 mtl		1,81 /mtl 453,50 /pc		
	3 mm	VP-018		20 mtl		1,93 /mtl 38,50 /pc		
		VP-018-CF300		■ 300 mtl		1,49 /mtl 447,50 /pc		
	2 mm	VP-019		20 mtl		1,93 /mtl 38,50 /pc		
		VP-019-CF400		■ 400 mtl		1,49 /mtl 596,30 /pc		

MIX

- Minimo ordine quantità indicata, anche assortiti
- Minimum order indicated quantity, also a mixture
- Mindestbestellmenge angeführten Menge, sortiert



- Trasporto fuori standard. Vedi condizioni di vendita
- Non-standard transport. See sales conditions
- Sondertransport. Siehe AGB

NO* Nero opaco - Matt black - Schwarz matt

- Disponibilità da verificare con ufficio commerciale
- Available to be checked with sales office
- Die Verfügbarkeit ist mit dem Verkaufsbüro abzustimmen

POS.	PROD.	ART.	MIS.	Q.TÀ	FIN.	EURO	FIN.	EURO
	P-059							▶ INDOOR 15
D. 17		P-059-3	3000 mm	1 pc	AN	106,50 /pc	IXE	126,70 /pc
		P-059-3-MIX	3000 mm	min 3 pc	AN	75,70 /pc	IXE	98,00 /pc
		P-059-6-MIX	6000 mm	min 3 pc	AN	134,70 /pc	IXE	177,50 /pc
		MIX	<ul style="list-style-type: none"> • Minimo ordine 3 pezzi, anche assortiti, fra i vari modelli della stessa misura • Minimum order 3 pcs also for combinations of various profiles of equal length • Mindestbestellmenge 3 Stück, auch sortiert nach verschiedenen Profilen und Dichtungen 					
D. 18		SECTOR M	3000 mm	12 pcs	AN	57,70 /pc 19,23 /mtl	GR	50,70 /pc 16,90 /mtl
			6000 mm	6 pcs	AN	108,00 /pc 18,00 /mtl	GR	93,70 /pc 15,62 /mtl
<p>MINIMO D'ORDINE: 8 profili da 6 mt o 16 profili da 3 mt (o multipli), anche assortiti tra i vari modelli, dello stesso settore di magazzino indicato in tabella (SECTOR).</p> <p>MINIMUM ORDER: No. 8 - 6 m profiles, or No. 16 - 3 m profiles, or No. 24 - 2 m profiles (or multiples), also in combination of different models, as long as they belong to the same warehouse sector indicated in the table (SECTOR).</p> <p>MINDESTBESTELLMENGE: 8 Profile mit 6 m oder 16 Profile mit 3 m (nur als Vielfaches), auch sortiert nach den verschiedenen Modellen, aber aus demselben Lagerort, der in der Tabelle angeführt ist (SECTOR).</p>								
D. 19		B-146	3000 mm	1 pc		32,00 /pc		
		IB-146	3000 mm	min 24 pcs		10,00 /pc		
		IB-146-CF140	3000 mm	140 pcs		7,74 /pc 1083,50 /set		
D. 20		P-069-CF4	Tappo Endcap Endkappe	4 pc	AN	10,58 /pc 42,30 /set	IXE	14,33 /pc 57,30 /set
D. 21		P-067-CF6		6 pc		45,30 /set		

- Confezioni industriali
- Industrial packaging
- Industrieverpackungen

- Confezioni profili con quantità fissa, disponibili solo in multipli della quantità indicata
- Packs of profiles with fixed quantity, available only in multiples of the indicated quantity
- Profilpackungen mit fixer Menge sind nur als Vielfaches der angeführten Menge erhältlich

CF

- Prezzi speciali per l'acquisto delle quantità minime indicate (CF) dell'articolo.
- NB: eventuali riordini o aggiunte per completamenti se di quantità inferiore alla minima, saranno fatturati al prezzo normale
- Special prices for the purchase of the minimum quantities indicated (CF) of the article.
- Note Well: any reorders or additions for completions of quantity less than the minimum will be invoiced at the normal price.
- Artikel mit Sonderpreisen bei Mindestabnahmemengen sind mit (CF) gekennzeichnet.
- Nachbestellungen oder Ergänzungen unter der Mindestabnahmemenge werden mit dem Normalpreis verrechnet.

POS.	PROD.	ART.	MIS.	Q.TÀ	FIN.	EURO	FIN.	EURO	
D. 22	 P-059 VP-016 (8 mm) VP-017 (10 mm) VP-018 (12 mm) VP-019 (12.76 mm)	VP-016	5 mm	20 mtl		3,14 /mtl 62,70 /pc			
		VP-016-CF150	5 mm	150 mtl		2,75 /mtl 412,00 /pc			
	 P-055 VP-017 (4 mm) VP-018 (3 mm) VP-019 (2 mm) VP-018 (3 mm) VP-018 (3 mm) VP-019 (2 mm) VP-019 (2 mm)	VP-017	4 mm	20 mtl		2,27 /mtl 45,30 /pc			
		VP-017-CF250	4 mm	250 mtl		1,81 /mtl 453,50 /pc			
	 VP-018 (3 mm) VP-018 (3 mm) VP-018 (3 mm) VP-019 (2 mm)	VP-018	3 mm	20 mtl		1,93 /mtl 38,50 /pc			
		VP-018-CF300	3 mm	300 mtl		1,49 /mtl 447,50 /pc			
	 VP-019 (2 mm) VP-019 (2 mm) VP-019 (2 mm) VP-019 (2 mm)	VP-019	2 mm	20 mtl		1,93 /mtl 38,50 /pc			
		VP-019-CF400	2 mm	400 mtl		1,49 /mtl 596,30 /pc			
	P-055 ▶ INDOOR 17								
	D. 23	 Dimensions: 6.13.5, 16.5, 21, 34	P-055-3-MIX	3000 mm	min 3 pcs	AN	68,30 /pc		
P-055-6-MIX			6000 mm	min 3 pcs	AN	121,50 /pc			
MIX			<ul style="list-style-type: none"> • Minimo ordine 3 pezzi, anche assortiti, fra i vari modelli della stessa misura • Minimum order 3 pcs also for combinations of various profiles of equal length • Mindestbestellmenge 3 Stück, auch sortiert nach verschiedenen Profilen und Dichtungen 						
D. 24		P-056	Profilo di chiusura da premontare per angolo Closing profile piece Endstück Profil			11,70 /pc			
D. 25		P-057	Tappo Endcap Endkappe	1 pcs	AN	11,30 /pc			

MIX

- Minimo ordine quantità indicata, anche assortiti
- Minimum order indicated quantity, also a mixture
- Mindestbestellmenge angeführten Menge, sortiert



- Trasporto fuori standard. Vedi condizioni di vendita
- Non-standard transport. See sales conditions
- Sondertransport. Siehe AGB

POS.	PROD.	ART.	MIS.	Q.TÀ	FIN.	EURO	FIN.	EURO
P-01								▶ INDOOR 16
D. 26		P-01-3	3000 mm	1 pc	AN	232,50 /pc	IXE	275,30 /pc
		P-01-3-MIX	3000 mm	min 3 pcs	AN	196,30 /pc	IXE	240,70 /pc
		P-01-6-MIX	6000 mm	min 3 pcs	AN	369,30 /pc	IXE	436,50 /pc
		MIX	<ul style="list-style-type: none"> • Minimo ordine 3 pezzi, anche assortiti, fra i vari modelli della stessa misura • Minimum order 3 pcs also for combinations of various profiles of equal length • Mindestbestellmenge 3 Stück, auch sortiert nach verschiedenen Profilen und Dichtungen 					
P-02								▶ INDOOR 16
D. 27		P-02-3	3000 mm	1 pc	AN	153,00 /pc	IXE	176,70 /pc
		P-02-3-MIX	3000 mm	min 3 pcs	AN	112,50 /pc	IXE	131,50 /pc
		P-02-6-MIX	6000 mm	min 3 pcs	AN	205,50 /pc	IXE	248,50 /pc
		MIX	<ul style="list-style-type: none"> • Minimo ordine 3 pezzi, anche assortiti, fra i vari modelli della stessa misura • Minimum order 3 pcs also for combinations of various profiles of equal length • Mindestbestellmenge 3 Stück, auch sortiert nach verschiedenen Profilen und Dichtungen 					
D. 28		P-01/02-TA-CF4	Tappo Endcap Endkappe	4 pcs	AN	10,75 /pc 43,00 /set	IXE	14,33 /pc 57,30 /set
D. 29		B-146	3000 mm	1 pc		32,00 /pc		
		IB-146	3000 mm	min 24 pcs		10,00 /pc		
		IB-146-CF140	3000 mm	140 pcs		7,74 /pc 1083,50 /set		
D. 30		P-067-CF6		6 pcs		45,30 /set		

- Confezioni industriali
- Industrial packaging
- Industrieverpackungen

- Confezioni profili con quantità fissa, disponibili solo in multipli della quantità indicata
- Packs of profiles with fixed quantity, available only in multiples of the indicated quantity
- Profilpackungen mit fixer Menge sind nur als Vielfaches der angeführten Menge erhältlich

CF

- Prezzi speciali per l'acquisto delle quantità minime indicate (CF) dell'articolo.
- NB: eventuali riordini o aggiunte per completamenti se di quantità inferiore alla minima, saranno fatturati al prezzo normale
- Special prices for the purchase of the minimum quantities indicated (CF) of the article.
- Note Well: any reorders or additions for completions of quantity less than the minimum will be invoiced at the normal price.
- Artikel mit Sonderpreisen bei Mindestabnahmemengen sind mit (CF) gekennzeichnet.
- Nachbestellungen oder Ergänzungen unter der Mindestabnahmemenge werden mit dem Normalpreis verrechnet.

POS.	PROD.	ART.	MIS.	Q.TÀ	FIN.	EURO	FIN.	EURO
------	-------	------	------	------	------	------	------	------

COMBINAZIONE P-01 CON P-02

COMBINATION P-01 WITH P-02 / KOMBINATION P-01 MIT P-02

▶ INDOOR 16

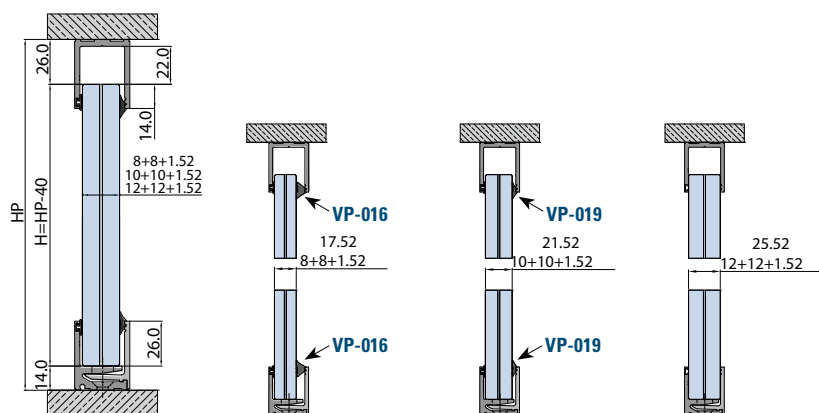

D. 31	 5 mm	VP-016	20 mtl	3,14 /mtl 62,70 /pc	
		VP-016-CF150	150 mtl	2,75 /mtl 412,00 /pc	
	 2 mm	VP-019	20 mtl	1,93 /mtl 38,50 /pc	
		VP-019-CF400	400 mtl	1,49 /mtl 596,30 /pc	

MIX

- Minimo ordine quantità indicata, anche assortiti
- Minimum order indicated quantity, also a mixture
- Mindestbestellmenge angeführten Menge, sortiert



- Trasporto fuori standard. Vedi condizioni di vendita
- Non-standard transport. See sales conditions
- Sondertransport. Siehe AGB

POS.	PROD.	ART.	MIS.	Q.TÀ	FIN.	EURO	FIN.	EURO	FIN.	EURO
CANALINE <i>U PROFILES / U-PROFILE</i>										
CANALINE "U" IN ALLUMINIO <i>U PROFILES IN ALUMINIUM / U-PROFILE AUS ALUMINIUM</i>										▶ INDOOR 18
D. 32		V-2036-MIX	3000 mm	min 5 pcs	CR	94,70 /pc	IXE	106,50 /pc	AN	97,00 /pc
		V-2036-CF8 ⚠	3000 mm	■ 8 pcs	CR	92,09 /pc 736,70 /8 pcs	IXE	103,79 /pc 830,30 /8 pcs	AN	94,41 /pc 755,30 /8 pcs
		V-2036-T	Tappo Endcap Endkappe	1 pc	IL	16,30 /pc	IX	18,70 /pc	AN	16,30 /pc
D. 33		V-2037-MIX	3000 mm	min 5 pcs	CR	93,70 /pc	IXE	103,00 /pc	AN	96,00 /pc
		V-2037-CF8 ⚠	3000 mm	■ 8 pcs	CR	91,21 /pc 729,70 /8 pcs	IXE	100,38 /pc 803,00 /8 pcs	AN	93,25 /pc 746,00 /8 pcs
		V-2037-T	Tappo Endcap Endkappe	1 pc	IL	16,30 /pc	IX	18,70 /pc	AN	16,30 /pc
D. 34		V-2038-MIX	3000 mm	min 5 pcs	CR	70,70 /pc	IXE	74,30 /pc	AN	68,50 /pc
		V-2038-CF10 ⚠	3000 mm	■ 10 pcs	CR	68,03 /pc 680,30 /10 pcs	IXE	71,70 /pc 717,00 /10 pcs	AN	64,57 /pc 645,70 /10 pcs
		V-2038-T	Tappo Endcap Endkappe	1 pc	IL	14,30 /pc	IX	16,30 /pc	AN	13,30 /pc
D. 35		V-2039-MIX	3000 mm	min 5 pcs	CR	68,50 /pc	IXE	72,30 /pc	AN	64,70 /pc
		V-2039-CF10 ⚠	3000 mm	■ 10 pcs	CR	65,07 /pc 650,70 /10 pcs	IXE	68,80 /pc 688,00 /10 pcs	AN	61,13 /pc 611,30 /10 pcs
		V-2039-T	Tappo Endcap Endkappe	1 pc	IL	14,30 /pc	IX	16,30 /pc	AN	13,30 /pc

- Confezioni industriali
- Industrial packaging
- Industrieverpackungen

- ⚠ Confezioni profili con quantità fissa, disponibili solo in multipli della quantità indicata
- Packs of profiles with fixed quantity, available only in multiples of the indicated quantity
- Profilpackungen mit fixer Menge sind nur als Vielfaches der angeführten Menge erhältlich

CF

- Prezzi speciali per l'acquisto delle quantità minime indicate (CF) dell'articolo.
- NB: eventuali riordini o aggiunte per completamenti se di quantità inferiore alla minima, saranno fatturati al prezzo normale
- Special prices for the purchase of the minimum quantities indicated (CF) of the article.
- Note Well: any reorders or additions for completions of quantity less than the minimum will be invoiced at the normal price.
- Artikel mit Sonderpreisen bei Mindestabnahmemengen sind mit (CF) gekennzeichnet.
- Nachbestellungen oder Ergänzungen unter der Mindestabnahmemenge werden mit dem Normalpreis verrechnet.

POS.	PROD.	ART.	MIS.	Q.TÀ	FIN.	EURO	FIN.	EURO	FIN.	EURO
D. 36		V-2040-MIX	3000 mm	min 5 pcs	CR	46,70 /pc	IXE	46,70 /pc	AN	35,00 /pc
		V-2040-CF14 ⚠	3000 mm	■ 14 pcs	CR	41,88 /pc 586,30 /14 pcs	IXE	41,88 /pc 586,30 /14 pcs	AN	30,64 /pc 429,00 /14 pcs
		V-2040-T	Tappo Endcap Endkappe	1 pc	IL	14,30 /pc	IX	16,30 /pc	AN	13,30 /pc
D. 37		V-2041-MIX	3000 mm	min 5 pcs	CR	45,70 /pc	IXE	45,70 /pc	AN	34,30 /pc
		V-2041-CF14 ⚠	3000 mm	■ 14 pcs	CR	41,31 /pc 578,30 /14 pcs	IXE	41,31 /pc 578,30 /14 pcs	AN	29,84 /pc 417,70 /14 pcs
		V-2041-T	Tappo Endcap Endkappe	1 pc	IL	14,30 /pc	IX	16,30 /pc	AN	13,30 /pc
D. 38		B-138-MIX	3000 mm	min 5 pcs	CR	47,30 /pc	AN	41,00 /pc		
		B-138-CF10 ⚠	3000 mm	■ 10 pcs	CR	43,93 /pc 439,30 /10 pcs	AN	37,33 /pc 373,30 /10 pcs		
D. 39		B-137-MIX	3000 mm	min 5 pcs	CR	46,70 /pc	AN	39,70 /pc		
		B-137-CF10 ⚠	3000 mm	■ 10 pcs	CR	42,80 /pc 428,00 /10 pcs	AN	35,93 /pc 359,30 /10 pcs		
D. 40		B-136-MIX	3000 mm	min 5 pcs	CR	42,30 /pc	NO	54,70 /pc		
		B-136-CF12 ⚠	3000 mm	■ 12 pcs	CR	38,19 /pc 458,30 /12 pcs	NO	50,83 /pc 610,00 /12 pcs		

MIX

- Minimo ordine quantità indicata, anche assortiti
- Minimum order indicated quantity, also a mixture
- Mindestbestellmenge angeführten Menge, sortiert

POS.	PROD.	ART.	MIS.	Q.TÀ	FIN.	EURO	FIN.	EURO	FIN.	EURO	
D. 41		V-2014-MIX	2000 mm	1 pc	AN	34,30 /pc	IXE	47,30 /pc	NO	44,30 /pc	
			3000 mm	1 pc	AN	41,70 /pc	IXE	62,30 /pc	NO	54,30 /pc	
			6000 mm	1 pc	AN	62,30 /pc	IXE	103,50 /pc	NO	81,00 /pc	
			MIX <ul style="list-style-type: none"> • Minimo ordine 5 pezzi, anche assortiti, fra i vari profili e guarnizioni • Minimum order 5 pcs also for combinations of various profiles and gaskets • Mindestbestellmenge 5 Stück, auch sortiert nach verschiedenen Profilen und Dichtungen 								
			V-2014-1500	1500	1 pc	AN	22,70 /pc	IXE	34,30 /pc	NO	30,00 /pc
			V-2014-3000	3000	1 pc	AN	46,00 /pc	IXE	68,50 /pc	NO	59,70 /pc
	<ul style="list-style-type: none"> • 1 pc da 1500 mm o 3000 mm acquistabile solo con sistema scorrevole • 1 pc of 1500 mm or 3000 mm purchasable just with sliding system • 1 Stück 1500 mm oder 3000 mm nur mit Schiebetürsystem käuflich 										
			VP-018	3 mm	20 mt		38,50 /pc				
			VP-019	2 mm	20 mt		38,50 /pc				
D. 42		V-2015-MIX	2000 mm	1 pc	AN	40,00 /pc	IXE	53,00 /pc			
			3000 mm	1 pc	AN	49,30 /pc	IXE	68,50 /pc			
			6000 mm	1 pc	AN	71,50 /pc	IXE	110,30 /pc			
			MIX <ul style="list-style-type: none"> • Minimo ordine 5 pezzi, anche assortiti, fra i vari profili e guarnizioni • Minimum order 5 pcs also for combinations of various profiles and gaskets • Mindestbestellmenge 5 Stück, auch sortiert nach verschiedenen Profilen und Dichtungen 								
		VP-019	2 mm	20 mt		38,50 /pc					

- Confezioni industriali
- Industrial packaging
- Industrieverpackungen

-
- Confezioni profili con quantità fissa, disponibili solo in multipli della quantità indicata
 - Packs of profiles with fixed quantity, available only in multiples of the indicated quantity
 - Profilpackungen mit fixer Menge sind nur als Vielfaches der angeführten Menge erhältlich

CF

- Prezzi speciali per l'acquisto delle quantità minime indicate (CF) dell'articolo.
- NB: eventuali riordini o aggiunte per completamenti se di quantità inferiore alla minima, saranno fatturati al prezzo normale
- Special prices for the purchase of the minimum quantities indicated (CF) of the article.
- Note Well: any reorders or additions for completions of quantity less than the minimum will be invoiced at the normal price.
- Artikel mit Sonderpreisen bei Mindestabnahmemengen sind mit (CF) gekennzeichnet.
- Nachbestellungen oder Ergänzungen unter der Mindestabnahmemenge werden mit dem Normalpreis verrechnet.

POS.	PROD.	ART.	MIS.	Q.TÀ	FIN.	EURO	FIN.	EURO	FIN.	EURO
CANALINE "U" INOX SPIGOLO VIVO <i>U PROFILES / U-PROFILE</i> ▶ INDOOR 20										
D. 43		V-2021-MIX	2500 mm	min 5 pcs	IX	49,30 /pc	IL	51,00 /pc		
		V-2021-CF10	2500 mm	■ 10 pcs	IX	45,53 /pc 455,30 /10 pcs	IL	47,40 /pc 474,00 /10 pcs		
D. 44		V-2020-MIX	2500 mm	min 5 pcs	IX	47,30 /pc	IL	49,30 /pc		
		V-2020-CF10	2500 mm	■ 10 pcs	IX	43,60 /pc 436,00 /10 pcs	IL	45,53 /pc 455,30 /10 pcs		
D. 45		V-2016-MIX	2500 mm	min 5 pcs	IX	45,70 /pc	IL	46,70 /pc		
		V-2016-CF10	2500 mm	■ 10 pcs	IX	41,87 /pc 418,70 /10 pcs	IL	42,80 /pc 428,00 /10 pcs		
D. 46		V-2017-MIX	2500 mm	min 5 pcs	IX	45,30 /pc	IL	46,30 /pc		
		V-2017-CF10	2500 mm	■ 10 pcs	IX	41,33 /pc 413,30 /10 pcs	IL	42,47 /pc 424,70 /10 pcs		
D. 47		V-2019-MIX	2500 mm	min 5 pcs	IX	44,00 /pc	IL	45,30 /pc		
		V-2019-CF10	2500 mm	■ 10 pcs	IX	40,50 /pc 405,00 /10 pcs	IL	41,33 /pc 413,30 /10 pcs		

MIX

- Minimo ordine quantità indicata, anche assortiti
- Minimum order indicated quantity, also a mixture
- Mindestbestellmenge angeführten Menge, sortiert



- Trasporto fuori standard. Vedi condizioni di vendita
- Non-standard transport. See sales conditions
- Sondertransport. Siehe AGB

POS.	PROD.	ART.	MIS.	Q.TÀ	FIN.	EURO	FIN.	EURO	FIN.	EURO
CANALINE "U" BORDO RIPIEGATO <i>U PROFILES WITH FOLDED EDGE / U-PROFILE MIT ABGERUNDETER KANTE</i> ▶ INDOOR 20										
D. 48		V-2030-MIX 	2500 mm	min 5 pcs	IX	77,50 /pc	IL	75,00 /pc		
		V-2030-CF10 ⚠️ 	2500 mm	■ 10 pcs	IX	73,40 /pc 734,00 /10 pcs	IL	71,10 /pc 711,00 /10 pcs		
D. 49		V-2016-R-MIX 	2500 mm	min 5 pcs	IX	71,50 /pc	IL	76,00 /pc		
		V-2016-R-CF10 ⚠️ 	2500 mm	■ 10 pcs	IX	68,03 /pc 680,30 /10 pcs	IL	72,25 /pc 722,50 /10 pcs		
D. 50		V-2017-R-MIX 	2500 mm	min 5 pcs	IX	71,50 /pc	IL	74,00 /pc		
		V-2017-R-CF10 ⚠️ 	2500 mm	■ 10 pcs	IX	67,10 /pc 671,00 /10 pcs	IL	70,33 /pc 703,30 /10 pcs		
D. 51		V-2029-MIX 	2500 mm	min 5 pcs	IX	69,50 /pc	IL	71,50 /pc		
		V-2029-CF10 ⚠️ 	2500 mm	■ 10 pcs	IX	65,73 /pc 657,30 /10 pcs	IL	67,67 /pc 676,70 /10 pcs		
ANGOLARI <i>L PROFILES / L-PROFILE</i> ▶ INDOOR 20										
D. 52		V-2025-MIX 	2500 mm	min 5 pcs	IX	51,70 /pc	IL	51,70 /pc		
		V-2025-CF10 ⚠️ 	2500 mm	■ 10 pcs	IX	47,60 /pc 476,00 /10 pcs	IL	47,60 /pc 476,00 /10 pcs		
D. 53		V-2024-MIX 	2500 mm	min 5 pcs	IX	38,00 /pc	IL	38,50 /pc		
		V-2024-CF10 ⚠️ 	2500 mm	■ 10 pcs	IX	34,40 /pc 344,00 /10 pcs	IL	34,77 /pc 347,70 /10 pcs		
D. 54		V-2023-MIX 	2500 mm	min 5 pcs	IX	35,30 /pc	IL	36,30 /pc		
		V-2023-CF10 ⚠️ 	2500 mm	■ 10 pcs	IX	31,33 /pc 313,30 /10 pcs	IL	32,13 /pc 321,30 /10 pcs		
D. 55		V-2022-MIX 	2500 mm	min 5 pcs	IX	34,30 /pc	IL	34,30 /pc		
		V-2022-CF10 ⚠️ 	2500 mm	■ 10 pcs	IX	29,05 /pc 290,50 /10 pcs	IL	29,05 /pc 290,50 /10 pcs		

- Confezioni industriali
- Industrial packaging
- Industrieverpackungen

- ⚠️ Confezioni profili con quantità fissa, disponibili solo in multipli della quantità indicata
- Packs of profiles with fixed quantity, available only in multiples of the indicated quantity
- Profilpackungen mit fixer Menge sind nur als Vielfaches der angeführten Menge erhältlich

CF

- Prezzi speciali per l'acquisto delle quantità minime indicate (CF) dell'articolo.
- NB: eventuali riordini o aggiunte per completamenti se di quantità inferiore alla minima, saranno fatturati al prezzo normale
- Special prices for the purchase of the minimum quantities indicated (CF) of the article.
- Note Well: any reorders or additions for completions of quantity less than the minimum will be invoiced at the normal price.
- Artikel mit Sonderpreisen bei Mindestabnahmemengen sind mit (CF) gekennzeichnet.
- Nachbestellungen oder Ergänzungen unter der Mindestabnahmemenge werden mit dem Normalpreis verrechnet.

POS.	PROD.	ART.	MIS.	Q.TÀ	FIN.	EURO	FIN.	EURO	FIN.	EURO
CANALINE CON ALETTA LATERALE										
<i>U PROFILES WITH SIDE PLATE / U-PROFILE MIT SEITLICHER PLATTE</i>										
▶ INDOOR 21										
D. 56		V-2028-MIX	2500 mm	min 5 pcs	IX	107,70 /pc	IL	107,70 /pc		
		V-2028-CF10	2500 mm	■ 10 pcs	IX	104,70 /pc 1047,00 /10 pcs	IL	104,70 /pc 1047,00 /10 pcs		
D. 57		V-2027-MIX	2500 mm	min 5 pcs	IX	109,50 /pc	IL	109,50 /pc		
		V-2027-CF10	2500 mm	■ 10 pcs	IX	106,33 /pc 1063,30 /10 pcs	IL	106,33 /pc 1063,30 /10 pcs		
D. 58		V-2026-MIX	2500 mm	min 5 pcs	IX	102,50 /pc	IL	104,00 /pc		
		V-2026-CF10	2500 mm	■ 10 pcs	IX	99,80 /pc 998,00 /10 pcs	IL	100,93 /pc 1009,30 /10 pcs		
CANALINE CON ALETTA										
<i>U PROFILES WITH PLATE / U-PROFILE MIT PLATTE</i>										
▶ INDOOR 21										
D. 59		V-2033-MIX	2500 mm	min 5 pcs	IX	106,50 /pc	IL	106,50 /pc		
		V-2033-CF10	2500 mm	■ 10 pcs	IX	103,80 /pc 1038,00 /10 pcs	IL	103,80 /pc 1038,00 /10 pcs		
D. 60		V-2032-MIX	2500 mm	min 5 pcs	IX	104,70 /pc	IL	104,70 /pc		
		V-2032-CF10	2500 mm	■ 10 pcs	IX	102,05 /pc 1020,50 /10 pcs	IL	102,05 /pc 1020,50 /10 pcs		
D. 61		V-2031-MIX	2500 mm	min 5 pcs	IX	104,00 /pc	IL	104,00 /pc		
		V-2031-CF10	2500 mm	■ 10 pcs	IX	100,93 /pc 1009,30 /10 pcs	IL	100,93 /pc 1009,30 /10 pcs		

MIX

- Minimo ordine quantità indicata, anche assortiti
- Minimum order indicated quantity, also a mixture
- Mindestbestellmenge angeführten Menge, sortiert

POS.	PROD.	ART.	MIS.	Q.TÀ	FIN.	EURO	FIN.	EURO	
PARETI DIVISORIE CON TRATTA FISSA E STIPITE COORDINATI <i>PARTITION WALLS WITH COORDINATED FRAMES / TRENNWÄNDE MIT KOORDINIERTEN ZARGEN</i>									
TP-210 EASY PARETE								INDOOR 24	
D. 62		TP-210 FIX	3000 mm	1 pc	AN	142,70 /pc 47,57 /mtl			
			6000 mm	1 pc	AN	218,70 /pc 36,45 /mtl	GR	190,30 /pc 31,72 /mtl	
		TP-210 MIS	3000 → 6000 mm	1 pc	AN	250,30 /pc	GR	221,70 /pc	
			SECTOR 4P		3000 mm	■ 8 pcs	AN	97,00 /pc 32,33 /mtl	
		6000 mm	■ 4 pcs	AN	179,30 /pc 29,88 /mtl				
<p>MINIMO D'ORDINE: 8 profili da 6 mt o 16 profili da 3 mt (o multipli ▲), anche assortiti tra i vari modelli, dello stesso settore di magazzino indicato in tabella (SECTOR).</p> <p>MINIMUM ORDER: No. 8 - 6 m profiles, or No. 16 - 3 m profiles, or No. 24 - 2 m profiles (or multiples ▲), also in combination of different models, as long as they belong to the same warehouse sector indicated in the table (SECTOR).</p> <p>MINDESTBESTELLMENGE: 8 Profile mit 6 m oder 16 Profile mit 3 m (nur als Vielfaches ▲), auch sortiert nach den verschiedenen Modellen, aber aus demselben Lagerort, der in der Tabelle angeführt ist (SECTOR).</p>									
D. 63		TP-211 FIX	3000 mm	1 pc	AN	237,50 /pc 79,17 /mtl			
D. 64		SECTOR 4P	3000 mm	■ 8 pcs	AN	104,00 /pc 34,67 /mtl			
			6000 mm	■ 4 pcs	AN	201,00 /pc 33,50 /mtl			
D. 65		SECTOR 4P	3000 mm	■ 8 pcs	AN	79,50 /pc 26,50 /mtl			
			6000 mm	■ 4 pcs	AN	151,70 /pc 25,28 /mtl			
<p>MINIMO D'ORDINE: 8 profili da 6 mt o 16 profili da 3 mt (o multipli ▲), anche assortiti tra i vari modelli, dello stesso settore di magazzino indicato in tabella (SECTOR).</p> <p>MINIMUM ORDER: No. 8 - 6 m profiles, or No. 16 - 3 m profiles, or No. 24 - 2 m profiles (or multiples ▲), also in combination of different models, as long as they belong to the same warehouse sector indicated in the table (SECTOR).</p> <p>MINDESTBESTELLMENGE: 8 Profile mit 6 m oder 16 Profile mit 3 m (nur als Vielfaches ▲), auch sortiert nach den verschiedenen Modellen, aber aus demselben Lagerort, der in der Tabelle angeführt ist (SECTOR).</p>									

- Confezioni industriali
- Industrial packaging
- Industrieverpackungen

- ▲ Confezioni profili con quantità fissa, disponibili solo in multipli della quantità indicata
- Packs of profiles with fixed quantity, available only in multiples of the indicated quantity
- Profilpackungen mit fixer Menge sind nur als Vielfaches der angeführten Menge erhältlich

CF

- Prezzi speciali per l'acquisto delle quantità minime indicate (CF) dell'articolo.
- NB: eventuali riordini o aggiunte per completamenti se di quantità inferiore alla minima, saranno fatturati al prezzo normale
- Special prices for the purchase of the minimum quantities indicated (CF) of the article.
- Note Well: any reorders or additions for completions of quantity less than the minimum will be invoiced at the normal price.
- Artikel mit Sonderpreisen bei Mindestabnahmemengen sind mit (CF) gekennzeichnet.
- Nachbestellungen oder Ergänzungen unter der Mindestabnahmemenge werden mit dem Normalpreis verrechnet.

POS.	PROD.	ART.	MIS.	Q.TÀ	FIN.	EURO	FIN.	EURO
D. 66		VP-210	Per vetro / For glass / Für Glas 10 mm, 5+5 (pvb 0,38 o 0,76)	24 mtl		3,51 /mtl 84,30 /set		
		IVP-210		■ min 100 mtl		3,30 /mtl		
		VP-210-12	Per vetro / For glass / Für Glas 6+6 (pvb 0,38), 5+5 (pvb 1,52)	24 mtl		3,51 /mtl 84,30 /set		
		IVP-210-12		■ min 100 mtl		3,30 /mtl		
D. 67		VP-200		10 pcs		58,30 /set 11,66 /mtl (2 pcs x mtl)		
		IVP-200		■ min 50 pcs		5,30 /pc		
D. 68		VP-221		1 pc		14,30 /pc		
		IVP-221		■ min 10 pcs		8,00 /pc		
D. 69		VP-220		1 pc		29,70 /pc		
		IVP-220		■ min 10 pcs		19,50 /pc		
D. 70		VP-222		1 pc		37,00 /pc		
		IVP-222		■ min 10 pcs		26,00 /pc		
D. 71		VP-223		1 pc		44,30 /pc		
		IVP-223		■ min 10 pcs		32,50 /pc		
D. 72		VP-30	Tappo Endcap Endkappe	1 pc		21,00 /pc		
D. 73	 OPTIONAL	VP-21-MIX		3000 mm	1 pc	32,50 /pc 10,83 /mtl		
		VP-21-CF100		3000 mm	100 pcs	28,66 /pc 2866,30 /set 9,55 /mtl		
D. 74	 OPTIONAL	VP-23-MIX		3000 mm	1 pc	74,00 /pc 24,67 /mtl		
		VP-23-CF50		3000 mm	50 pcs	70,28 /pc 3514,00 /set 23,43 /mtl		
D. 75	 OPTIONAL	VP-24-MIX		3000 mm	1 pc	84,30 /pc 28,10 /mtl		
		VP-24-CF50		3000 mm	50 pcs	80,25 /pc 4012,50 /set 26,75 /mtl		
D. 76	 OPTIONAL	VP-31-MIX		3000 mm	1 pc	Prezzo su richiesta Price on request Preis auf Anfrage		
		VP-31-CF50		3000 mm	50 pcs	Prezzo su richiesta Price on request Preis auf Anfrage		

MIX

- Minimo ordine quantità indicata, anche assortiti
- Minimum order indicated quantity, also a mixture
- Mindestbestellmenge angeführten Menge, sortiert



- Trasporto fuori standard. Vedi condizioni di vendita
- Non-standard transport. See sales conditions
- Sondertransport. Siehe AGB

POS.	PROD.	ART.	MIS.	Q.TÀ	FIN.	EURO	FIN.	EURO
EASY PARETE STIPITE COORDINATO COORDINATED FRAMES / KOORDINIERTEN ZARGEN						▶ INDOOR 32		
D. 77		TP-201	max 950 x 2500 mm	1 pc	AN	630,00 /pc	GR	551,30 /pc
			max 1000 x 2800 mm	1 pc	AN	740,00 /pc	GR	643,30 /pc
					NO*	+ 30%		
<ul style="list-style-type: none"> • Obbligatorio comunicare misure H e LS • Please always specify sizes H and LS • Bitte immer Maßen H und LS angeben 								
D. 78		TP-202 FIX	1500 mm	1 pc	AN	138,00 /pc	GR	121,00 /pc
			3000 mm	1 pc	AN	250,30 /pc	GR	212,50 /pc
			6000 mm	1 pc	AN	452,30 /pc	GR	380,00 /pc
		TP-202 MIS	3000 → 6000 mm	1 pc	AN	482,00 /pc	GR	409,70 /pc
					NO*	+ 30%		
SECTOR 4P		ITP-202	3000 mm	8 pcs	AN	222,30 /pc 74,10 /mtl		
			6000 mm	4 pcs	AN	408,30 /pc 68,05 /mtl		
<p>MINIMO D'ORDINE: 8 profili da 6 mt o 16 profili da 3 mt (o multipli), anche assortiti tra i vari modelli, dello stesso settore di magazzino indicato in tabella (SECTOR).</p> <p>MINIMUM ORDER: No. 8 - 6 m profiles, or No. 16 - 3 m profiles, or No. 24 - 2 m profiles (or multiples), also in combination of different models, as long as they belong to the same warehouse sector indicated in the table (SECTOR).</p> <p>MINDESTBESTELLMENGE: 8 Profile mit 6 m oder 16 Profile mit 3 m (nur als Vielfaches), auch sortiert nach den verschiedenen Modellen, aber aus demselben Lagerort, der in der Tabelle angeführt ist (SECTOR).</p>								
D. 79		VP-250		2 pcs		67,70 /set		
		IVP-250		min 10 set		47,00 /set		
D. 80		VP-251		4 pcs		37,00 /set		
		IVP-251		min 10 set		17,30 /set		

Confezioni industriali
• Industrial packaging
• Industrieverpackungen

Confezioni profili con quantità fissa, disponibili solo in multipli della quantità indicata
• Packs of profiles with fixed quantity, available only in multiples of the indicated quantity
• Profilpackungen mit fixer Menge sind nur als Vielfaches der angeführten Menge erhältlich

Trasporto fuori standard. Vedi condizioni di vendita
• Non-standard transport. See sales conditions
• Sondertransport. Siehe AGB

POS.	PROD.	ART.	MIS.	Q.TÀ	FIN.	EURO	FIN.	EURO
D. 81		VP-240		1 pcs		34,70 /pcs		
		IVP-240		■ min 10 pcs		27,30 /pcs		
D. 82		VP-015			AG	4,70 /mtl		
					NO	6,00 /mtl		
		IVP-015		■ min 100 mtl	AG	4,00 /mtl		
					NO	5,00 /mtl		
IVP-015-240 mt		■ 240 mtl	AG	2,70 /mtl 648,00 /set				
			NO	3,50 /mtl 840,00 /set				
D. 83		VP-210	Per vetro / For glass / Für Glas 10 mm, 5+5 (pvb 0,38 o 0,76)	24 mtl		3,51 /mtl 84,30 /set		
		IVP-210		■ min 100 mtl		3,30 /mtl		
		VP-210-12	Per vetro / For glass / Für Glas 6+6 (pvb 0,38), 5+5 (pvb 1,52)	24 mtl		3,51 /mtl 84,30 /set		
		IVP-210-12		■ min 100 mtl		3,30 /mtl		
D. 84		TP-203	<ul style="list-style-type: none"> Vite per regolazione profilo verticale stipite muro. Profilo tubolare 15 x 30 non fornito. Vertical leveler for adjustment door frame/wall. Profile 15 x 30 not included. Vertikal Stellfüß für die Einrichtung von Tüorzarge. Profil 15 x 30 nicht inkl. 	8 pcs		148,30 /set		
D. 85		LAV-200	<ul style="list-style-type: none"> Lavorazione stipite TP-201. Obbligatorio completare formulario per quote. Profiles preparation TP-201. Please complete obligatory scheme. Profilbearbeitung TP-201. Bitte obligatorische Formular ausfüllen. <p>▶ 542</p> <p>CP-015 incluso / included / enthalten</p>			190,30		
D. 86	<p>Fori filettati Threaded holes Gewindebohrungen</p> <p>Fresatura per scrocco Milling for latch Fräsung Schlosstalle</p>	LAV-200-M	<ul style="list-style-type: none"> Lavorazione stipite TP-201 per serrature magnetiche. Profiles preparation TP-201 for magnetic locks. Profilbearbeitung TP-201 für magnetische Schlösser. <p>CP-015-M incluso / included / enthalten</p>			203,30		
			<ul style="list-style-type: none"> Fresatura per regolazione a cura del cliente Milling for adjustment by the customer Fräsung für Verstellung bauseits 					

NO* Nero opaco - Matt black - Schwarz matt

- Disponibilità da verificare con ufficio commerciale
- Available to be checked with sales office
- Die Verfügbarkeit ist mit dem Verkaufsbüro abzustimmen

POS.	PROD.	ART.	MIS.	Q.TÀ	FIN.	EURO		
TP-410 DUAL GLASS						▶ INDOOR 25		
D. 87		TP-410 FIX	3000 mm	1 pc	AN	233,30 /pc 77,77 /mtl		
			6000 mm	1 pc	AN	378,30 /pc 63,05 /mtl		
		TP-410 MIS	3000 → 6000 mm	1 pc	AN	411,00 /pc		
			SECTOR 4P		3000 mm	■ 8 pcs	AN	154,30 /pc 51,43 /mtl
				ITP-410 ⚠	6000 mm	■ 4 pcs	AN	301,30 /pc 50,22 /mtl
		<p>MINIMO D'ORDINE: 8 profili da 6 mt o 16 profili da 3 mt (o multipli ⚠), anche assortiti tra i vari modelli, dello stesso settore di magazzino indicato in tabella (SECTOR).</p> <p>MINIMUM ORDER: No. 8 - 6 m profiles, or No. 16 - 3 m profiles, or No. 24 - 2 m profiles (or multiples ⚠), also in combination of different models, as long as they belong to the same warehouse sector indicated in the table (SECTOR).</p> <p>MINDESTBESTELLMENGE: 8 Profile mit 6 m oder 16 Profile mit 3 m (nur als Vielfaches ⚠), auch sortiert nach den verschiedenen Modellen, aber aus demselben Lagerort, der in der Tabelle angeführt ist (SECTOR).</p>						
D. 88		TP-411 FIX	3000 mm	1 pc	AN	297,50 /pc 99,17 /mtl		
D. 89		SECTOR 4P	3000 mm	■ 8 pcs	AN	129,50 /pc 43,17 /mtl		
			6000 mm	■ 4 pcs	AN	243,50 /pc 40,58 /mtl		
D. 90		SECTOR 4P	3000 mm	■ 8 pcs	AN	79,50 /pc 26,50 /mtl		
			6000 mm	■ 4 pcs	AN	151,70 /pc 25,28 /mtl		
<p>MINIMO D'ORDINE: 8 profili da 6 mt o 16 profili da 3 mt (o multipli ⚠), anche assortiti tra i vari modelli, dello stesso settore di magazzino indicato in tabella (SECTOR).</p> <p>MINIMUM ORDER: No. 8 - 6 m profiles, or No. 16 - 3 m profiles, or No. 24 - 2 m profiles (or multiples ⚠), also in combination of different models, as long as they belong to the same warehouse sector indicated in the table (SECTOR).</p> <p>MINDESTBESTELLMENGE: 8 Profile mit 6 m oder 16 Profile mit 3 m (nur als Vielfaches ⚠), auch sortiert nach den verschiedenen Modellen, aber aus demselben Lagerort, der in der Tabelle angeführt ist (SECTOR).</p>								

- Confezioni industriali
- Industrial packaging
- Industrieverpackungen

- ⚠ Confezioni profili con quantità fissa, disponibili solo in multipli della quantità indicata
- Packs of profiles with fixed quantity, available only in multiples of the indicated quantity
- Profilpackungen mit fixer Menge sind nur als Vielfaches der angeführten Menge erhältlich

CF

- Prezzi speciali per l'acquisto delle quantità minime indicate (CF) dell'articolo.
- NB: eventuali riordini o aggiunte per completamenti se di quantità inferiore alla minima, saranno fatturati al prezzo normale
- Special prices for the purchase of the minimum quantities indicated (CF) of the article.
- Note Well: any reorders or additions for completions of quantity less than the minimum will be invoiced at the normal price.
- Artikel mit Sonderpreisen bei Mindestabnahmemengen sind mit (CF) gekennzeichnet.
- Nachbestellungen oder Ergänzungen unter der Mindestabnahmemenge werden mit dem Normalpreis verrechnet.

POS.	PROD.	ART.	MIS.	Q.TÀ	FIN.	EURO
D. 91		VP-210	Per vetro / For glass / Für Glas 10 mm, 5+5 (pvb 0,38 o 0,76)	24 mtl		3,51 /mtl 84,30 /set
		IVP-210		■ min 100 mtl		3,30 /mtl
		VP-210-12	Per vetro / For glass / Für Glas 6+6 (pvb 0,38), 5+5 (pvb 1,52)	24 mtl		3,51 /mtl 84,30 /set
		IVP-210-12		■ min 100 mtl		3,30 /mtl
D. 92		VP-200		10 pcs		58,30 /set 23,32 /mtl (4 pcs x mtl)
		IVP-200		■ min 50 pcs		5,30 /pc
D. 93		VP-221		1 pc		14,30 /pc
		IVP-221		■ min 10 pcs		8,00 /pc
D. 94		VP-220		1 pc		29,70 /pc
		IVP-220		■ min 10 pcs		19,50 /pc
D. 95		VP-222		1 pc		37,00 /pc
		IVP-222		■ min 10 pcs		26,00 /pcs
D. 96		VP-32	Tappo Endcap Endkappe	1 pc		34,30 /pc
D. 97		VP-21-MIX		3000 mm	1 pc	32,50 /pc 10,83 /mtl
		VP-21-CF100		3000 mm	100 pcs	
D. 98		VP-23-MIX		3000 mm	1 pc	74,00 /pc 24,67 /mtl
		VP-23-CF50		3000 mm	50 pcs	
D. 99		VP-24-MIX		3000 mm	1 pc	84,30 /pc 28,10 /mtl
		VP-24-CF50		3000 mm	50 pcs	

MIX

- Minimo ordine quantità indicata, anche assortiti
- Minimum order indicated quantity, also a mixture
- Mindestbestellmenge angeführten Menge, sortiert



- Trasporto fuori standard. Vedi condizioni di vendita
- Non-standard transport. See sales conditions
- Sondertransport. Siehe AGB

POS.	PROD.	ART.	MIS.	Q.TÀ	FIN.	EURO			
DUAL GLASS STIPIE COORDINATO COORDINATED FRAMES / KOORDINIERTEN ZARGEN						▶ INDOOR 33			
D. 100		TP-401	max 1000 x 2800 mm	1 pc	AN	937,70 /pc			
							<ul style="list-style-type: none"> • Obbligatorio comunicare misure H e LS • Please always specify sizes H and LS • Bitte immer Maßen H und LS angeben 		
D. 101	<p>non incluso not included nicht enthalten</p> <p>VP-015</p> <p>VP-210 non incluso not included nicht enthalten</p>	TP-402	1500 mm 3000 mm 6000 mm 3000 → 6000 mm	1 pc 1 pc 1 pc 1 pc	AN	224,00 /pc			
						362,70 /pc			
						596,30 /pc			
						629,70 /pc			
						SECTOR 4P ITP-402 ⚠️	3000 mm	■ 8 pcs	AN 251,00 /pc 83,67 /mtl
						6000 mm	■ 4 pcs	AN 494,00 /pc 82,33 /mtl	
<p>MINIMO D'ORDINE: 8 profili da 6 mt o 16 profili da 3 mt (o multipli ⚠️), anche assortiti tra i vari modelli, dello stesso settore di magazzino indicato in tabella (SECTOR).</p> <p>MINIMUM ORDER: No. 8 - 6 m profiles, or No. 16 - 3 m profiles, or No. 24 - 2 m profiles (or multiples ⚠️), also in combination of different models, as long as they belong to the same warehouse sector indicated in the table (SECTOR).</p> <p>MINDESTBESTELLMENGE: 8 Profile mit 6 m oder 16 Profile mit 3 m (nur als Vielfaches ⚠️), auch sortiert nach den verschiedenen Modellen, aber aus demselben Lagerort, der in der Tabelle angeführt ist (SECTOR).</p>									
D. 102		VP-450	4 pc	■ min 10 set	AN	135,00 /set			
						93,70 /set			
D. 103		VP-440	1 pc	■ min 10 pcs	AN	34,70 /pc			
						27,30 /pc			

- Confezioni industriali
- Industrial packaging
- Industrieverpackungen

- ⚠️ Confezioni profili con quantità fissa, disponibili solo in multipli della quantità indicata
- Packs of profiles with fixed quantity, available only in multiples of the indicated quantity
- Profilpackungen mit fixer Menge sind nur als Vielfaches der angeführten Menge erhältlich

- Trasporto fuori standard. Vedi condizioni di vendita
- Non-standard transport. See sales conditions
- Sondertransport. Siehe AGB

POS.	PROD.	ART.	MIS.	Q.TÀ	FIN.	EURO
D. 104		VP-015			AG	4,70 /mtl
					NO	6,00 /mtl
		IVP-015		■ min 100 mtl	AG	4,00 /mtl
					NO	5,00 /mtl
		IVP-015-240 mt		■ 240 mtl	AG	2,70 /mtl 648,00 /set
					NO	3,50 /mtl 840,00 /set
D. 105		VP-210	Per vetro / For glass / Für Glas 10 mm, 5+5 (pvb 0,38 o 0,76)	24 mtl		3,51 /mtl 84,30 /set
		IVP-210		■ min 100 mtl		3,30 /mtl
		VP-210-12	Per vetro / For glass / Für Glas 6+6 (pvb 0,38), 5+5 (pvb 1,52)	24 mtl		3,51 /mtl 84,30 /set
		IVP-210-12		■ min 100 mtl		3,30 /mtl
D. 106		TP-203	<ul style="list-style-type: none"> Vite per regolazione profilo verticale stipite muro. Profilo tubolare 15 x 30 non fornito. Vertical leveler for adjustment door frame/wall. Profile 15 x 30 not included. Vertikal Stellfüß für die Einrichtung von Türzarge. Profil 15 x 30 nicht inkl. 	8 pcs		148,30 /set
			<ul style="list-style-type: none"> Fresatura per regolazione a cura del cliente Milling for adjustment by the customer Fräsung für Verstellung bauseits 			

POS.	PROD.	ART.	MIS.	Q.TÀ	FIN.	EURO
DUAL GLASS PORTA DOOR / TÜR						▶ INDOOR 33
D. 107		TP-405 DX 	max 950 x 2700 mm B DESTRA - RECHTS - RIGHT D DESTRA - RECHTS - RIGHT 	1 set	AN	2182,30 /set
		TP-405 SX 	max 950 x 2700 mm A SINISTRA - LINKS - LEFT C SINISTRA - LINKS - LEFT 			
<ul style="list-style-type: none"> • Obbligatorio comunicare misure HM, LA e senso di apertura • Please always specify sizes HM, LA and opening direction • Bitte immer Maßen HM, LA und Öffnungsrichtung angeben 						

D. 108		TP-412 FIX Con guarnizioni With gaskets Mit Dichtungen	3000 mm	1 pc	AN	392,00 /pc
		6000 mm	1 pc	AN	639,00 /pc	
		TP-412 MIS Con guarnizioni With gaskets Mit Dichtungen	3000 → 6000 mm	1 pc	AN	673,30 /pc
SECTOR 4P	ITP-412 Senza guarnizioni Without gaskets Ohne Dichtungen	6000 mm	min 8 pcs	AN	487,00 /pc 81,17 /mtl	
<p>MINIMO D'ORDINE: 8 profili da 6 mt o 16 profili da 3 mt (o multipli ▲), anche assortiti tra i vari modelli, dello stesso settore di magazzino indicato in tabella (SECTOR).</p> <p>MINIMUM ORDER: No. 8 - 6 m profiles, or No. 16 - 3 m profiles, or No. 24 - 2 m profiles (or multiples ▲), also in combination of different models, as long as they belong to the same warehouse sector indicated in the table (SECTOR).</p> <p>MINDESTBESTELLMENGE: 8 Profile mit 6 m oder 16 Profile mit 3 m (nur als Vielfaches ▲), auch sortiert nach den verschiedenen Modellen, aber aus demselben Lagerort, der in der Tabelle angeführt ist (SECTOR).</p>						

- Confezioni industriali
- Industrial packaging
- Industrieverpackungen

- Confezioni profili con quantità fissa, disponibili solo in multipli della quantità indicata
- Packs of profiles with fixed quantity, available only in multiples of the indicated quantity
- Profilpackungen mit fixer Menge sind nur als Vielfaches der angeführten Menge erhältlich

- Trasporto fuori standard. Vedi condizioni di vendita
- Non-standard transport. See sales conditions
- Sondertransport. Siehe AGB















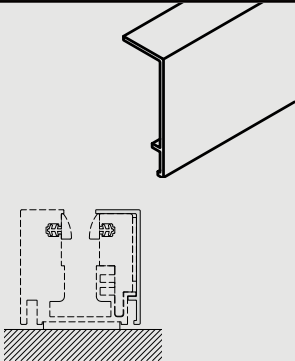
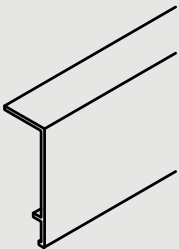

POS.	PROD.	ART.	MIS.	Q.TÀ	FIN.	EURO
D. 109		TP-411-PS Con guarnizioni With gaskets Mit Dichtungen	2000 mm	1 pc	AN	238,00 /pc
			6000 mm	1 pc	AN	524,70 /pc
		TP-411-PS MIS Con guarnizioni With gaskets Mit Dichtungen	3000 → 6000 mm	1 pc	AN	558,70 /pc
		SECTOR 4P ITP-411-PS-TRAV Senza guarnizioni Without gaskets Ohne Dichtungen	6000 mm	■ min 8 pcs	AN	386,70 /pc 64,45 /mtl
<p>MINIMO D'ORDINE: 8 profili da 6 mt o 16 profili da 3 mt (o multipli ▲), anche assortiti tra i vari modelli, dello stesso settore di magazzino indicato in tabella (SECTOR). MINIMUM ORDER: No. 8 - 6 m profiles, or No. 16 - 3 m profiles, or No. 24 - 2 m profiles (or multiples ▲), also in combination of different models, as long as they belong to the same warehouse sector indicated in the table (SECTOR). MINDESTBESTELLMENGE: 8 Profile mit 6 m oder 16 Profile mit 3 m (nur als Vielfaches ▲), auch sortiert nach den verschiedenen Modellen, aber aus demselben Lagerort, der in der Tabelle angeführt ist (SECTOR).</p>						
D. 110		IVP-401-GUARN	3400 mm	■ min 20 pcs		13,50 /pc
D. 111		P-F28		1 set		61,00 /set
		IP-F28		■ min 5 set		48,30 /set
D. 112		V-765 PZ DX (B - D) V-765 PZ SX (A - C)		1 pc		168,00 /pc
		V-765 PZ DX (B - D) V-765 PZ SX (A - C)		■ min 5 pcs		96,00 /pc
D. 113		C-023		1 pc		47,70 /pc
D. 114		V-123-SD		1 pair		152,50 /pair
		V-123-SD		■ min 5 pairs		111,30 /pair
D. 115		P-F29		1 pc		Prezzo su richiesta Price on request Preis auf Anfrage

POS.	PROD.	ART.	MIS.	Q.TÀ	FIN.	EURO	
	TP-010					▶ INDOOR 26	
D. 116		TP-010		1 pc	AN	85,70 /mtl	
D. 117		TP-002 FIX	3000 mm	1 pc	AN	175,70 /pc	
			6000 mm	1 pc	AN	296,30 /pc	
		TP-002 MIS	3000 → 6000 mm	1 pc	AN	324,70 /pc	
		SECTOR 4P	ITP-002	6000 mm	4 pcs	AN	251,00 /pc 41,83 /mtl
		<p>MINIMO D'ORDINE: 8 profili da 6 mt o 16 profili da 3 mt (o multipli), anche assortiti tra i vari modelli, dello stesso settore di magazzino indicato in tabella (SECTOR).</p> <p>MINIMUM ORDER: No. 8 - 6 m profiles, or No. 16 - 3 m profiles, or No. 24 - 2 m profiles (or multiples), also in combination of different models, as long as they belong to the same warehouse sector indicated in the table (SECTOR).</p> <p>MINDESTBESTELLMENGE: 8 Profile mit 6 m oder 16 Profile mit 3 m (nur als Vielfaches), auch sortiert nach den verschiedenen Modellen, aber aus demselben Lagerort, der in der Tabelle angeführt ist (SECTOR).</p>					
D. 118		TP-020	200 mm	1 pc	AN	27,70 /pc	
		SECTOR 4P	ITP-020	200 mm	min 50 pcs	AN	18,30 /pc
		<p>MINIMO D'ORDINE: 8 profili da 6 mt o 16 profili da 3 mt (o multipli), anche assortiti tra i vari modelli, dello stesso settore di magazzino indicato in tabella (SECTOR).</p> <p>MINIMUM ORDER: No. 8 - 6 m profiles, or No. 16 - 3 m profiles, or No. 24 - 2 m profiles (or multiples), also in combination of different models, as long as they belong to the same warehouse sector indicated in the table (SECTOR).</p> <p>MINDESTBESTELLMENGE: 8 Profile mit 6 m oder 16 Profile mit 3 m (nur als Vielfaches), auch sortiert nach den verschiedenen Modellen, aber aus demselben Lagerort, der in der Tabelle angeführt ist (SECTOR).</p>					

- Confezioni industriali
- Industrial packaging
- Industrieverpackungen

- Confezioni profili con quantità fissa, disponibili solo in multipli della quantità indicata
- Packs of profiles with fixed quantity, available only in multiples of the indicated quantity
- Profilpackungen mit fixer Menge sind nur als Vielfaches der angeführten Menge erhältlich

- Trasporto fuori standard. Vedi condizioni di vendita
- Non-standard transport. See sales conditions
- Sondertransport. Siehe AGB

POS.	PROD.	ART.	MIS.	Q.TÀ	FIN.	EURO
D. 119		TP-015 FIX	3000 mm	1 pc	AN	114,00 /pc
			 6000 mm	1 pc	AN	169,70 /pc
		TP-015 MIS	3000 → 6000 mm	1 pc	AN	197,50 /pc
		SECTOR 4P	ITP-015 	 6000 mm	 4 pcs	AN
<p>MINIMO D'ORDINE: 8 profili da 6 mt o 16 profili da 3 mt (o multipli ), anche assortiti tra i vari modelli, dello stesso settore di magazzino indicato in tabella (SECTOR).</p> <p>MINIMUM ORDER: No. 8 - 6 m profiles, or No. 16 - 3 m profiles, or No. 24 - 2 m profiles (or multiples ), also in combination of different models, as long as they belong to the same warehouse sector indicated in the table (SECTOR).</p> <p>MINDESTBESTELLMENGE: 8 Profile mit 6 m oder 16 Profile mit 3 m (nur als Vielfaches ), auch sortiert nach den verschiedenen Modellen, aber aus demselben Lagerort, der in der Tabelle angeführt ist (SECTOR).</p>						
D. 120		TP-030		1 pc	AN	51,00 /mtl
D. 121		TP-008 FIX	3000 mm	1 pc	AN	86,30 /pc
			 6000 mm	1 pc	AN	139,00 /pc
		TP-008 MIS	3000 → 6000 mm	1 pc	AN	168,00 /pc
		SECTOR 4P	ITP-008 	 6000 mm	 4 pcs	AN
<p>MINIMO D'ORDINE: 8 profili da 6 mt o 16 profili da 3 mt (o multipli ), anche assortiti tra i vari modelli, dello stesso settore di magazzino indicato in tabella (SECTOR).</p> <p>MINIMUM ORDER: No. 8 - 6 m profiles, or No. 16 - 3 m profiles, or No. 24 - 2 m profiles (or multiples ), also in combination of different models, as long as they belong to the same warehouse sector indicated in the table (SECTOR).</p> <p>MINDESTBESTELLMENGE: 8 Profile mit 6 m oder 16 Profile mit 3 m (nur als Vielfaches ), auch sortiert nach den verschiedenen Modellen, aber aus demselben Lagerort, der in der Tabelle angeführt ist (SECTOR).</p>						

POS.	PROD.	ART.	MIS.	Q.TÀ	FIN.	EURO
D. 122		VP-010		24 mtl		59,00 2,46 /mtl
D. 123		TP-006		20 mtl		97,00 4,85 /mtl
D. 124		VP-105		2 pcs		6,50 /2 pcs (4 pcs x mtl)
D. 125		VP-100		10 pcs		9,70 /pc 97,00 /set 19,40 /mtl (2 pcs x mtl)
		IVP-100		■ min 50 pcs		10,00 /pc
D. 126		VP-130		1 pc		34,70 /pc
		IVP-130		■ min 10 pcs		24,50 /pc
D. 127		VP-120		1 pc		27,00 /pc
		IVP-120		■ min 10 pcs		17,30 /pc
D. 128		VP-122		1 pc		32,00 /pc
		IVP-122		■ min 10 pcs		20,50 /pc
D. 129		VP-124		1 pc		40,30 /pc
		IVP-124		■ min 10 pcs		25,50 /pc
D. 130		VP-126		1 pc		51,00 /pc
		IVP-126		■ min 10 pcs		30,30 /pc

- Confezioni industriali
- Industrial packaging
- Industrieverpackungen

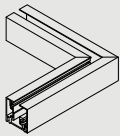
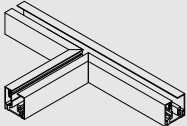
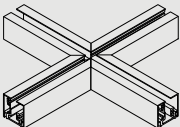
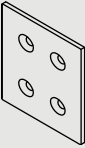
POS.	PROD.	ART.	MIS.	Q.TÀ	FIN.	EURO
D. 131		TP-050		1 pc	AN	238,00 /pc
D. 132		TP-060		1 pc	AN	349,00 /pc
D. 133		TP-070		1 pc	AN	412,00 /pc
D. 134		VP-20S		1 pc	AN	21,00 /pc

POS.	PROD.	ART.	MIS.	Q.TÀ	FIN.	EURO
TP-100 STIPITE COORDINATO COORDINATED FRAMES / KOORDINIERTEN ZARGEN ▶ INDOOR 35						
D. 135		TP-100	max 950 x 2500 mm	1 pc	AN	583,50 /pc
			max 1000 x 2800 mm	1 pc	AN	699,30 /pc
<ul style="list-style-type: none"> • Obbligatorio comunicare misure H e LP • Please always specify sizes H and LP • Bitte immer Maßen H und LP angeben 						
D. 136	<p>Fori filettati Threaded holes Gewindebohrungen</p> <p>Fresatura per scrocco Milling for latch Fräsung Schlossfalle</p>	LAV-100 <ul style="list-style-type: none"> • Lavorazione stipite TP-100. Obbligatorio completare formulario per quote. • Profiles preparation TP-100. Please complete obligatory scheme. • Profilbearbeitung TP-100. Bitte obligatorische Formular ausfüllen. <p>▶ 541</p> <p>CP-015 incluso / included / enthalten</p>				190,30
D. 137		LAV-100-M <ul style="list-style-type: none"> • Lavorazione stipite TP-100 per serrature magnetiche. • Profiles preparation TP-100 for magnetic locks. • Profilbearbeitung TP-100 für magnetische Schlösser. <p>CP-015-M incluso / included / enthalten</p>				203,30
D. 138		VP-140		1 pc		34,70 /pc
		IVP-140		■ min 10 pcs		24,50 /pc
D. 139	<p>VP-010 VP-015</p> <p>VP-210 / VP-015 not included</p>	TP-102 B FIX	3000 mm	1 pc	AN	232,30 /pc
			6000 mm	1 pc	AN	420,30 /pc
		TP-102 B MIS	3000 → 6000 mm	1 pc	AN	450,00 /pc
		SECTOR 4P ITP-102	3000 mm	■ 8 pcs	AN	193,50 /pc 64,50 /mtl
			6000 mm	■ 4 pcs	AN	372,50 /pc 62,08 /mtl
<p>MINIMO D'ORDINE: 8 profili da 6 mt o 16 profili da 3 mt (o multipli), anche assortiti tra i vari modelli, dello stesso settore di magazzino indicato in tabella (SECTOR).</p> <p>MINIMUM ORDER: No. 8 - 6 m profiles, or No. 16 - 3 m profiles, or No. 24 - 2 m profiles (or multiples), also in combination of different models, as long as they belong to the same warehouse sector indicated in the table (SECTOR).</p> <p>MINDESTBESTELLMENGE: 8 Profile mit 6 m oder 16 Profile mit 3 m (nur als Vielfaches), auch sortiert nach den verschiedenen Modellen, aber aus demselben Lagerort, der in der Tabelle angeführt ist (SECTOR).</p>						

■ Confezioni industriali
• Industrial packaging
• Industrieverpackungen

Confezioni profili con quantità fissa, disponibili solo in multipli della quantità indicata
• Packs of profiles with fixed quantity, available only in multiples of the indicated quantity
• Profilpackungen mit fixer Menge sind nur als Vielfaches der angeführten Menge erhältlich

Trasporto fuori standard. Vedi condizioni di vendita
• Non-standard transport. See sales conditions
• Sondertransport. Siehe AGB

POS.	PROD.	ART.	MIS.	Q.TÀ	FIN.	EURO	
D. 140		P-033 FIX	1500 mm	1 pc	AN	57,70 /pc	
			3000 mm	1 pc	AN	77,50 /pc	
			6000 mm	1 pc	AN	133,30 /pc	
		P-033 MIS	3000 → 6000 mm	1 pc	AN	162,00 /pc	
			SECTOR 4P	IP-033	3000 mm	8 pcs	AN
		6000 mm			4 pcs	AN	100,70 /pc 16,78 /mtl
		<p>MINIMO D'ORDINE: 8 profili da 6 mt o 16 profili da 3 mt (o multipli), anche assortiti tra i vari modelli, dello stesso settore di magazzino indicato in tabella (SECTOR).</p> <p>MINIMUM ORDER: No. 8 - 6 m profiles, or No. 16 - 3 m profiles, or No. 24 - 2 m profiles (or multiples), also in combination of different models, as long as they belong to the same warehouse sector indicated in the table (SECTOR).</p> <p>MINDESTBESTELLMENGE: 8 Profile mit 6 m oder 16 Profile mit 3 m (nur als Vielfaches), auch sortiert nach den verschiedenen Modellen, aber aus demselben Lagerort, der in der Tabelle angeführt ist (SECTOR).</p>					
D. 141		VP-010		24 mtl		59,00 2,46 /mtl	
D. 142		VP-015			AG	4,70 /mtl	
					NO	6,00 /mtl	
		IVP-015		min 100 mtl	AG	4,00 /mtl	
					NO	5,00 /mtl	
			IVP-015-240 mt		240 mtl	AG	2,70 /mtl 648,00 /set
		NO		3,50 /mtl 840,00 /set			
D. 143		VP-150		2 pcs		68,70 /set	
		IVP-150		min 10 set		44,00 /set	

POS.	PROD.	ART.	MIS.	Q.TÀ	FIN.	EURO
------	-------	------	------	------	------	------

D. 144		TP-110	max 950 x 2500 mm max 1000 x 2800 mm	1 pc	AN	457,30 /pc
				1 pc	GR	420,30 /pc
				1 pc	AN	544,00 /pc
				1 pc	GR	499,30 /pc
				NO*		+ 30%

• Obbligatorio comunicare misure H e LS
 • Please always specify sizes H and LS
 • Bitte immer Maßen H und LS angeben

D. 145	<p>Fori filettati / Threaded holes / Gewindebohrungen Fresatura per scrocco / Milling for latch / Fräsung Schlossfalle</p>	LAV-110	<ul style="list-style-type: none"> Lavorazione stipite TP-110. Obbligatorio completare formulario per quote. Profiles preparation TP-110. Please complete obligatory scheme. Profilbearbeitung TP-110. Bitte obligatorische Formular ausfüllen. ▶ 543 CP-015 incluso / included / enthalten			190,30
--------	--	----------------	--	--	--	--------

D. 146	<p>VP-210 / VP-015 not included</p>	TP-111 FIX	1500 mm 3000 mm 6000 mm	1 pc	AN	122,00 /pc
					GR	114,00 /pc
				1 pc	AN	179,30 /pc
					GR	161,50 /pc
				1 pc	AN	286,70 /pc
					GR	251,00 /pc
TP-111 MIS	3000 → 6000 mm	1 pc	AN	320,30 /pc		
			GR	283,50 /pc		
				NO*		+ 30%
SECTOR 4P	TP-111	3000 mm	6000 mm	8 pcs	AN	118,50 /pc 39,50 /mtl
				4 pcs	AN	229,00 /pc 38,17 /mtl

MINIMO D'ORDINE: 8 profili da 6 mt o 16 profili da 3 mt (o multipli), anche assortiti tra i vari modelli, dello stesso settore di magazzino indicato in tabella (SECTOR).
MINIMUM ORDER: No. 8 - 6 m profiles, or No. 16 - 3 m profiles, or No. 24 - 2 m profiles (or multiples), also in combination of different models, as long as they belong to the same warehouse sector indicated in the table (SECTOR).
MINDESTBESTELLMENGE: 8 Profile mit 6 m oder 16 Profile mit 3 m (nur als Vielfaches), auch sortiert nach den verschiedenen Modellen, aber aus demselben Lagerort, der in der Tabelle angeführt ist (SECTOR).

- Confezioni industriali / Industrial packaging / Industrieverpackungen

- Confezioni profili con quantità fissa, disponibili solo in multipli della quantità indicata / Packs of profiles with fixed quantity, available only in multiples of the indicated quantity / Profilpackungen mit fixer Menge sind nur als Vielfaches der angeführten Menge erhältlich

CF

- Prezzi speciali per l'acquisto delle quantità minime indicate (CF) dell'articolo. NB: eventuali riordini o aggiunte per completamenti se di quantità inferiore alla minima, saranno fatturati al prezzo normale.
- Special prices for the purchase of the minimum quantities indicated (CF) of the article. Note Well: any reorders or additions for completions of quantity less than the minimum will be invoiced at the normal price.
- Artikel mit Sonderpreisen bei Mindestabnahmemengen sind mit (CF) gekennzeichnet. Nachbestellungen oder Ergänzungen unter der Mindestabnahmemenge werden mit dem Normalpreis verrechnet.

POS.	PROD.	ART.	MIS.	Q.TÀ	FIN.	EURO
D. 147		VP-015			AG	4,70 /mtl
					NO	6,00 /mtl
		IVP-015		■ min 100 mtl	AG	4,00 /mtl
					NO	5,00 /mtl
		IVP-015-240 mt		■ 240 mtl	AG	2,70 /mtl 648,00 /set
					NO	3,50 /mtl 840,00 /set
D. 148		P-115-CF2		2 pcs		57,70 set
		P-115-CF2		■ min 5 set		43,30 /set
D. 149		P-114		1 pc		35,00 pc
		P-114		■ min 5 pcs		24,50 /pc
D. 150		VP-210		24 mtl		3,51 /mtl 84,30 /set
		IVP-210		■ min 100 mtl		3,30 /mtl
D. 151		V-037		1 pc	IX	11,30 /pc
		V-037-CF10		■ 10 pcs	IX	6,30 /pc



- Trasporto fuori standard. Vedi condizioni di vendita
- Non-standard transport. See sales conditions
- Sondertransport. Siehe AGB

NO* Nero opaco - Matt black - Schwarz matt

- Disponibilità da verificare con ufficio commerciale
- Available to be checked with sales office
- Die Verfügbarkeit ist mit dem Verkaufsbüro abzustimmen

POS.	PROD.	ART.
------	-------	------

PPS EVOLUTION ▶ INDOOR 27

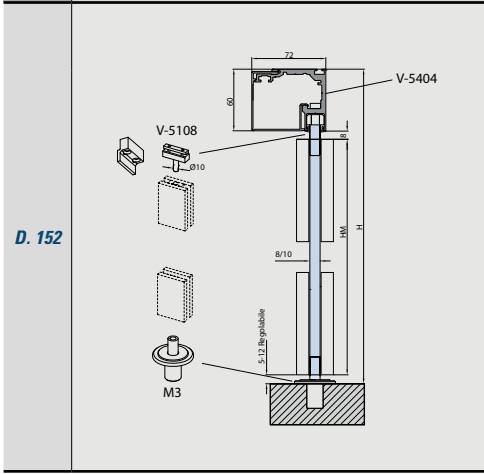

P1 PORTA / PIVOT DOOR / DREHTÜR

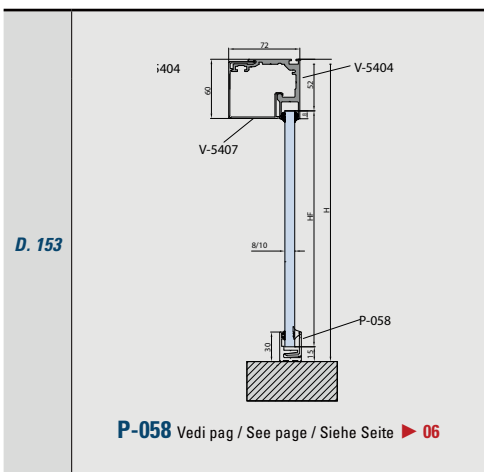
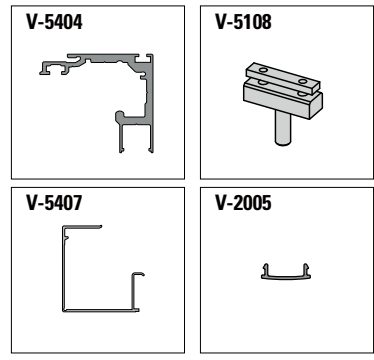

P2 PORTA / PIVOT DOOR / DREHTÜR

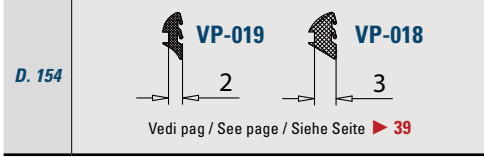
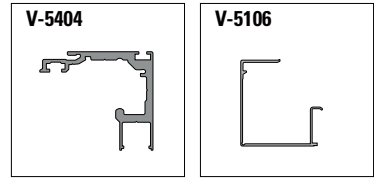

OPTIONAL

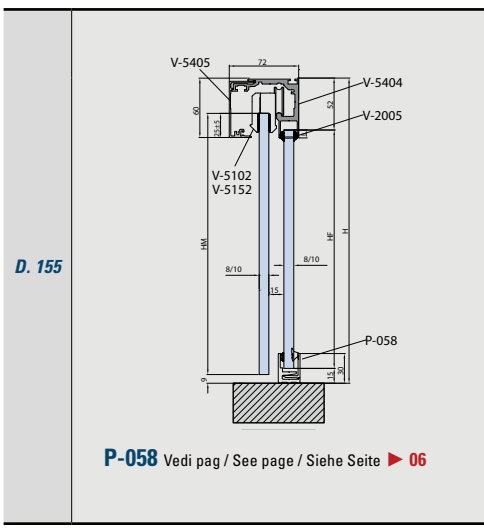

S3 SCORREVOLE / SLIDING DOOR / SCHIEBETÜR

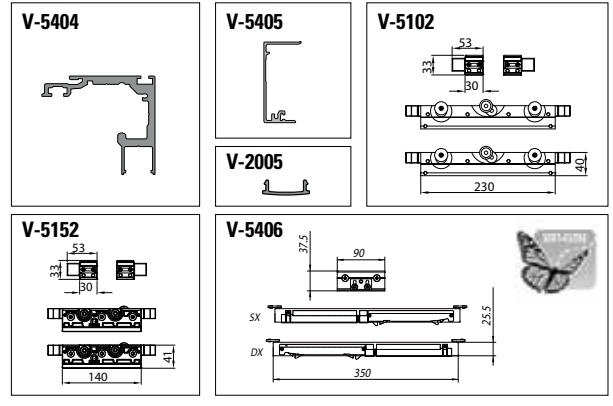

- Confezioni industriali
 - Industrial packaging
 - Industrieverpackungen
- !**
- Confezioni profili con quantità fissa, disponibili solo in multipli della quantità indicata
 - Packs of profiles with fixed quantity, available only in multiples of the indicated quantity
 - Profilpackungen mit fixer Menge sind nur als Vielfaches der angeführten Menge erhältlich

- 🚚**
- Trasporto fuori standard. Vedi condizioni di vendita
 - Non-standard transport. See sales conditions
 - Sondertransport. Siehe AGB

POS.	PROD.	ART.	MIS.	Q.TÀ	FIN.	EURO	FIN.	EURO
D. 156		V-5404			AN	125,00 /mtl		
		V-5404 B FIX	6000 mm		AN	103,50 /mtl		
		IV-5403-BIN-FIX	6000 mm	■ 2 pcs	AN	434,30 /pc 72,38 /mtl	IXE	555,50 /pc 92,58 /mtl
		MINIMO D'ORDINE: 2 profili da 6 mt (o multipli) MINIMUM ORDER: No. 2 - 6 m profiles (or multiples) MINDESTBESTELLMENGE: 2 Profile mit 6 m (nur als Vielfaches)						
D. 158		V-5405			AN	61,50 /mtl		
		V-5405 B FIX	6000 mm		AN	44,00 /mtl		
		<ul style="list-style-type: none"> • Velella vendibile solo con binario di pari lunghezza. • Cover profile available only packed with rail profile. • Profilabdeckung lieferbar nur mit Laufschiene verpackt. 						
		IV-5400-VELETTA	6000 mm	■ 2 pcs	AN	114,00 /pc 19,00 /mtl	IXE	185,00 /pc 30,83 /mtl
MINIMO D'ORDINE: 2 profili da 6 mt (o multipli) MINIMUM ORDER: No. 2 - 6 m profiles (or multiples) MINDESTBESTELLMENGE: 2 Profile mit 6 m (nur als Vielfaches)								
D. 159		V-5407			AN	71,30 /mtl		
		V-5407 B FIX	6000 mm		AN	47,00 /mtl		
		<ul style="list-style-type: none"> • Velella vendibile solo con binario di pari lunghezza. • Cover profile available only packed with rail profile. • Profilabdeckung lieferbar nur mit Laufschiene verpackt. 						
		IV-5407-VELETTA	6000 mm	■ 2 pcs	AN	140,30 /pc 23,38 /mtl		
MINIMO D'ORDINE: 2 profili da 6 mt (o multipli) MINIMUM ORDER: No. 2 - 6 m profiles (or multiples) MINDESTBESTELLMENGE: 2 Profile mit 6 m (nur als Vielfaches)								
D. 160		V-2005			AN	29,70 /mtl		

POS.	PROD.	ART.	MIS.	Q.TÀ	FIN.	EURO	FIN.	EURO	FIN.	EURO	
D. 161		V-5102		1 set		183,50/set					
		V-5102	■	min 10 set		170,50/set					
D. 162		V-5152		1 set		111,30/set					
		V-5152	■	min 10 set		93,70/set					
D. 163		V-5406-70 C		1 set		91,70/set					
		V-5406-70 C	■	min 10 set		67,00/set					
		V-5406		1 set		121,30/set					
		V-5406	■	min 10 set		114,00/set					
		V-5406-120		1 set		247,30/set					
		V-5406-120	■	min 10 set		232,70/set					
D. 164		V-012		1 pc	AN	18,30/pc	NS	21,70/pc	CR	21,70/pc	
		V-012	■	min 10 pcs	AN	12,50/pc	NS	15,70/pc	CR	15,70/pc	
D. 165		MQ-1		1 pc	AN	144,30/pc			CR	181,00/pc	
D. 166		M-3		1 pc	NS	59,50/pc					
D. 167		V-5108		1 pc		58,00/pc					
D. 168		V-5109		1 pc		86,70/pc					

- Confezioni industriali
- Industrial packaging
- Industrieverpackungen



- Confezioni profili con quantità fissa, disponibili solo in multipli della quantità indicata
- Packs of profiles with fixed quantity, available only in multiples of the indicated quantity
- Profilpackungen mit fixer Menge sind nur als Vielfaches der angeführten Menge erhältlich

CF

- Prezzi speciali per l'acquisto delle quantità minime indicate (CF) dell'articolo.
- NB: eventuali riordini o aggiunte per completamenti se di quantità inferiore alla minima, saranno fatturati al prezzo normale
- Special prices for the purchase of the minimum quantities indicated (CF) of the article.
- Note Well: any reorders or additions for completions of quantity less than the minimum will be invoiced at the normal price.
- Artikel mit Sonderpreisen bei Mindestabnahmemengen sind mit (CF) gekennzeichnet.
- Nachbestellungen oder Ergänzungen unter der Mindestabnahmemenge werden mit dem Normalpreis verrechnet.

POS.	PROD.	ART.	MIS.	Q.TÀ	FIN.	EURO	FIN.	EURO	
D. 169		P-058-3	3000 mm	1 pc	AN	161,50 /pc	IXE	191,30 /pc	
					NO	194,00 /pc	XO	232,00 /pc	
					BI BC BS	254,00 pc			
		P-058-3-MIX	3000 mm	■ min 3 pcs	AN	122,00 /pc	IXE	156,50 /pc	
					NO	146,30 /pc	XO	208,00 /pc	
					BI BC BS	226,50 pc			
		P-058-6-MIX	6000 mm	■ min 3 pcs	AN	222,00 /pc	IXE	291,50 /pc	
					NO	266,50 /pc	XO	350,00 /pc	
					BI BC BS	382,00 pc			
MIX <ul style="list-style-type: none"> • Minimo ordine 3 pezzi, anche assortiti, fra i vari modelli della stessa misura • Minimum order 3 pcs also for combinations of various profiles of equal length • Mindestbestellmenge 3 Stück, auch sortiert nach verschiedenen Profilen und Dichtungen 									

D. 170		SECTOR M	IP-058-PROF	3000 mm	■ 8 pcs	AN	72,30 /pc 24,10 /mtl	GR	64,70 /pc 21,57 /mtl
				6000 mm	■ 4 pcs	AN	136,30 /pc 22,72 /mtl	GR	122,00 /pc 20,33 /mtl
D. 171		SECTOR M	IP-058-CART	3000 mm	■ 16 pcs	AN	36,30 /pc 12,10 /mtl	GR	29,00 /pc 9,67 /mtl
				6000 mm	■ 8 pcs	AN	64,70 /pc 10,78 /mtl	GR	50,70 /pc 8,45 /mtl
<p>MINIMO D'ORDINE: 8 profili da 6 mt o 16 profili da 3 mt (o multipli), anche assortiti tra i vari modelli, dello stesso settore di magazzino indicato in tabella (SECTOR).</p> <p>MINIMUM ORDER: No. 8 - 6 m profiles, or No. 16 - 3 m profiles, or No. 24 - 2 m profiles (or multiples), also in combination of different models, as long as they belong to the same warehouse sector indicated in the table (SECTOR).</p> <p>MINDESTBESTELLMENGE: 8 Profile mit 6 m oder 16 Profile mit 3 m (nur als Vielfaches), auch sortiert nach den verschiedenen Modellen, aber aus demselben Lagerort, der in der Tabelle angeführt ist (SECTOR).</p>									

D. 172		VP-016	20 mtl	3,14 /mtl 62,70 /pc	
		VP-016-CF150	■ 150 mtl	2,75 /mtl 412,00 /pc	
D. 173		VP-017	20 mtl	2,27 /mtl 45,30 /pc	
		VP-017-CF250	■ 250 mtl	1,81 /mtl 453,50 /pc	
D. 174		VP-018	20 mtl	1,93 /mtl 38,50 /pc	
		VP-018-CF300	■ 300 mtl	1,49 /mtl 447,50 /pc	
D. 175		VP-019	20 mtl	1,93 /mtl 38,50 /pc	
		VP-019-CF400	■ 400 mtl	1,49 /mtl 596,30 /pc	

MIX

- Minimo ordine quantità indicata, anche assortiti
- Minimum order indicated quantity, also a mixture
- Mindestbestellmenge angeführten Menge, sortiert



- Trasporto fuori standard. Vedi condizioni di vendita
- Non-standard transport. See sales conditions
- Sondertransport. Siehe AGB

POS.	PROD.	ART.	MIS.		Q.TÀ	FIN.	EURO	
PROFILI IN POLICARBONATO		POLYCARBONAT PROFILES / POLYCARBONATE PROFILE					► INDOOR 28	
D. 176		VP-40-MIX	3000 mm	mm 8	min 5 pcs	26,30 /pc 8,77 /mtl		
		VP-40-CF100	3000 mm	mm 8	■ 100 pcs	21,44 /pc 7,15 /mtl 2144,30 /100 pcs		
D. 177		VP-41-MIX	3000 mm	mm 10	min 5 pcs	27,30 /pc 9,10 /mtl		
		VP-41-CF100	3000 mm	mm 10	■ 100 pcs	22,13 /pc 7,38 /mtl 2213,00 /100 pcs		
D. 178		VP-42-MIX	3000 mm	mm 5+5+1,52 pvb	min 5 pcs	27,70 /pc 9,23 /mtl		
		VP-42-CF100	3000 mm	mm 5+5+1,52 pvb	■ 100 pcs	22,13 /pc 7,38 /mtl 2213,00 /100 pcs		
D. 179		VP-43-MIX	3000 mm	12 mm	min 5 pcs	28,00 /pc 9,33 /mtl		
		VP-43-CF100	3000 mm	12 mm	■ 100 pcs	22,36 /pc 7,45 /mtl 2235,70 /100 pcs		
D. 180		VP-44-MIX	3000 mm	mm 6+6+1,52 pvb	min 5 pcs	49,50 /pc 16,50 /mtl		
		VP-44-CF100	3000 mm	mm 6+6+1,52 pvb	■ 100 pcs	42,99 /pc 14,33 /mtl 4299,30 /100 pcs		
D. 181		VP-21-MIX	3000 mm	10 mm	min 5 pcs	32,50 /pc 10,83 /mtl		
		VP-21-CF100	3000 mm	10 mm	■ 100 pcs	28,66 /pc 9,55 /mtl 2866,30 /100 pcs		
D. 182		VP-22-MIX	3000 mm	mm 12 mm 6+6+1,52 pvb	min 5 pcs	39,70 /pc 13,23 /mtl		
		VP-22-CF100	3000 mm	mm 12 mm 6+6+1,52 pvb	■ 100 pcs	35,20 /pc 11,73 /mtl 3520,00 /100 pcs		

- Confezioni industriali
- Industrial packaging
- Industrieverpackungen



- Confezioni profili con quantità fissa, disponibili solo in multipli della quantità indicata
- Packs of profiles with fixed quantity, available only in multiples of the indicated quantity
- Profilpackungen mit fixer Menge sind nur als Vielfaches der angeführten Menge erhältlich

CF

- Prezzi speciali per l'acquisto delle quantità minime indicate (CF) dell'articolo.
- NB: eventuali riordini o aggiunte per completamenti se di quantità inferiore alla minima, saranno fatturati al prezzo normale
- Special prices for the purchase of the minimum quantities indicated (CF) of the article.
- Note Well: any reorders or additions for completions of quantity less than the minimum will be invoiced at the normal price.
- Artikel mit Sonderpreisen bei Mindestabnahmemengen sind mit (CF) gekennzeichnet.
- Nachbestellungen oder Ergänzungen unter der Mindestabnahmemenge werden mit dem Normalpreis verrechnet.

POS.	PROD.	ART.	MIS.		Q.TÀ	FIN.	EURO
D. 183		VP-23-MIX	3000 mm	mm 10 - 12 mm 6+6+1,52 pvb	min 5 pcs		74,00 /pc 24,67 /mtl
		VP-23-CF50	3000 mm	mm 10 - 12 mm 6+6+1,52 pvb	■ 50 pcs		70,28 /pc 23,43 /mtl 3514,00 /50 pcs
D. 184		VP-24-MIX	3000 mm	mm 10 - 12 mm 6+6+1,52 pvb	min 5 pcs		84,30 /pc 28,10 /mtl
		VP-24-CF50	3000 mm	mm 10 - 12 mm 6+6+1,52 pvb	■ 50 pcs		80,25 /pc 26,75 /mtl 4012,50 /50 pcs
D. 185							
D. 186							
D. 186.1		WRU-C-BUMP-MT12			12 mt		247,30 /12 m 20,61 /mt
D. 187		WRU-M 80/50 MT5		8 mm	5 mt		77,50 /pc 15,50 /mt

MIX

- Minimo ordine quantità indicata, anche assortiti
- Minimum order indicated quantity, also a mixture
- Mindestbestellmenge angeführten Menge, sortiert







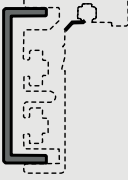

POS.	PROD.	ART.	MIS.	Q.TÀ	FIN.	EURO	
STIPI TI SU MURO (CON PROFILI OPTIONAL PER FISSAGGIO VETRO FISSO) ALUMINIUM FRAMES (WITH OPTIONAL CLIP-ON PROFILES FOR FIXED SIDE PANELS) ALUZARGEN (MIT OPTIONALEN KLIPS PROFILE FÜR SEITENTEILEN)							
						▶ INDOOR 30	
P-030 / P-030-V						▶ INDOOR 36 ▶ INDOOR 42	
D. 188		P-030	max 950 x 2500 mm	1 pc	AN	413,30 /pc	
			max 1000 x 2800 mm	1 pc	AN	477,00 /pc	
					NO*	+ 30%	
<ul style="list-style-type: none"> • Obbligatorio comunicare misure H e LP • Please always specify sizes H and LP • Bitte immer Maßen H und LP angeben 							
D. 189		LAV-030	<ul style="list-style-type: none"> • Lavorazione stipse P-030. Obbligatorio completare formulario per quote. • Profiles preparation P-030. Please complete obligatory scheme. • Profilbearbeitung P-030. Bitte obligatorische Formular ausfüllen. 		2 Cerniere 2 Hinges 2 Bänder	190,30	
			<ul style="list-style-type: none"> ▶ 536 		3 Cerniere 3 Hinges 3 Bänder	221,00	
D. 190		LAV-030-M	<ul style="list-style-type: none"> • Lavorazione stipse P-030 per serrature magnetiche. • Profiles preparation P-030 for magnetic locks. • Profilbearbeitung P-030 für magnetische Schlösser. 		2 Cerniere 2 Hinges 2 Bänder	203,30	
			<ul style="list-style-type: none"> ▶ CP-015-M incluso / included / enthalten 		3 Cerniere 3 Hinges 3 Bänder	234,30	
D. 191		P-031	<ul style="list-style-type: none"> • Preforato a passo per fissaggio a muro • Pre-drilled for wall installation • Vorgebohrt für Wandmontage 				
			P-031 FIX	1500 mm	1 pc	AN	109,30 /pc
				3000 mm	1 pc	AN	176,70 /pc
				6000 mm	1 pc	AN	320,30 /pc
			P-031 MIS	3000 → 6000 mm	1 pc	AN	350,30 /pc
						NO* + 30%	
<ul style="list-style-type: none"> • Preforato a passo per fissaggio a muro • Pre-drilled for wall installation • Vorgebohrt für Wandmontage 							
SECTOR 4P		IP-031			AN	143,70 /pc 47,90 /mtl	
				3000 mm	4 pcs		
			6000 mm	2 pcs	AN	279,70 /pc 46,62 /mtl	
MINIMO D'ORDINE: 8 profili da 6 mt o 16 profili da 3 mt (o multipli), anche assortiti tra i vari modelli, dello stesso settore di magazzino indicato in tabella (SECTOR). MINIMUM ORDER: No. 8 - 6 m profiles, or No. 16 - 3 m profiles, or No. 24 - 2 m profiles (or multiples), also in combination of different models, as long as they belong to the same warehouse sector indicated in the table (SECTOR). MINDESTBESTELLMENGE: 8 Profile mit 6 m oder 16 Profile mit 3 m (nur als Vielfaches), auch sortiert nach den verschiedenen Modellen, aber aus demselben Lagerort, der in der Tabelle angeführt ist (SECTOR).							

Confezioni industriali
Industrial packaging
Industrieverpackungen

Confezioni profili con quantità fissa, disponibili solo in multipli della quantità indicata
Packs of profiles with fixed quantity, available only in multiples of the indicated quantity
Profilpackungen mit fixer Menge sind nur als Vielfaches der angeführten Menge erhältlich

CF

Prezzi speciali per l'acquisto delle quantità minime indicate (CF) dell'articolo.
NB: eventuali riordini o aggiunte per completamenti se di quantità inferiore alla minima, saranno fatturati al prezzo normale.
Special prices for the purchase of the minimum quantities indicated (CF) of the article.
Note Well: any reorders or additions for completions of quantity less than the minimum will be invoiced at the normal price.
Artikel mit Sonderpreisen bei Mindestabnahmemengen sind mit (CF) gekennzeichnet.
Nachbestellungen oder Ergänzungen unter der Mindestabnahmemenge werden mit dem Normalpreis verrechnet.

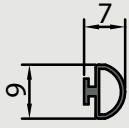
POS.	PROD.	ART.	MIS.	Q.TÀ	FIN.	EURO
D. 192	 <p>OPTIONAL</p>	P-033 FIX	1500 mm	1 pc	AN	57,70 /pc
			3000 mm	1 pc	AN	77,50 /pc
			 6000 mm	1 pc	AN	133,30 /pc
		P-033 MIS	3000 → 6000 mm	1 pc	AN	162,00 /pc
					NO*	+ 30%
		SECTOR 4P		IP-033 	3000 mm	■ 8 pcs
 6000 mm	■ 4 pcs				AN	100,70 /pc 16,78 /mtl
<p>MINIMO D'ORDINE: 8 profili da 6 mt o 16 profili da 3 mt (o multipli ), anche assortiti tra i vari modelli, dello stesso settore di magazzino indicato in tabella (SECTOR).</p> <p>MINIMUM ORDER: No. 8 - 6 m profiles, or No. 16 - 3 m profiles, or No. 24 - 2 m profiles (or multiples ), also in combination of different models, as long as they belong to the same warehouse sector indicated in the table (SECTOR).</p> <p>MINDESTBESTELLMENGE: 8 Profile mit 6 m oder 16 Profile mit 3 m (nur als Vielfaches ), auch sortiert nach den verschiedenen Modellen, aber aus demselben Lagerort, der in der Tabelle angeführt ist (SECTOR).</p>						
D. 193		P-012-CF4		■ 4 pcs		46,30 /set
D. 194		VP-015			AG	4,70 /mtl
					NO	6,00 /mtl
		IVP-015		■ min 100 mtl	AG	4,00 /mtl
					NO	5,00 /mtl
		IVP-015-240 mt		■ 240 mtl	AG	2,70 /mtl 648,00 /set
					NO	3,50 /mtl 840,00 /set
D. 195		B-146	3000 mm	1 pc		32,00 /pc
		IB-146	3000 mm	■ min 24 pcs		10,00 /set
		IB-146-CF140	3000 mm	■ 140 pcs		7,74 /pc 1083,50 /set



- Trasporto fuori standard. Vedi condizioni di vendita
- Non-standard transport. See sales conditions
- Sondertransport. Siehe AGB

NO* Nero opaco - Matt black - Schwarz matt

- Disponibilità da verificare con ufficio commerciale
- Available to be checked with sales office
- Die Verfügbarkeit ist mit dem Verkaufsbüro abzustimmen

POS.	PROD.	ART.	MIS.	Q.TÀ	FIN.	EURO
D. 196		P-088-3	3000 mm	1 pc	AN	117,50 /set
		P-088-6	6000 mm	1 pc	AN	173,50 /set

D. 197		SECTOR 4P	IP-088-A	3000 mm	8 pcs	AN	40,00 /pc 13,33 /mtl
			6000 mm	4 pcs	AN	72,30 /pc 12,05 /mtl	
D. 198		SECTOR 4P	IP-088-B	3000 mm	8 pcs	AN	43,30 /pc 14,43 /mtl
			6000 mm	4 pcs	AN	79,30 /pc 13,22 /mtl	

MINIMO D'ORDINE: 8 profili da 6 mt o 16 profili da 3 mt (o multipli), anche assortiti tra i vari modelli, dello stesso settore di magazzino indicato in tabella (SECTOR).
MINIMUM ORDER: No. 8 - 6 m profiles, or No. 16 - 3 m profiles, or No. 24 - 2 m profiles (or multiples), also in combination of different models, as long as they belong to the same warehouse sector indicated in the table (SECTOR).
MINDESTBESTELLMENGE: 8 Profile mit 6 m oder 16 Profile mit 3 m (nur als Vielfaches), auch sortiert nach den verschiedenen Modellen, aber aus demselben Lagerort, der in der Tabelle angeführt ist (SECTOR).

D. 199					
		VP-016		20 mtl	3,14 /mtl 62,70 /pc
		VP-016-CF150		150 mtl	2,75 /mtl 412,00 /pc
		VP-017		20 mtl	2,27 /mtl 45,30 /pc
		VP-017-CF250		250 mtl	1,81 /mtl 453,50 /pc
		VP-019		20 mtl	1,93 /mtl 38,50 /pc
VP-019-CF400			400 mtl	1,49 /mtl 596,30 /pc	

- Confezioni industriali
- Industrial packaging
- Industrieverpackungen

- Confezioni profili con quantità fissa, disponibili solo in multipli della quantità indicata
- Packs of profiles with fixed quantity, available only in multiples of the indicated quantity
- Profilpackungen mit fixer Menge sind nur als Vielfaches der angeführten Menge erhältlich

CF

- Prezzi speciali per l'acquisto delle quantità minime indicate (CF) dell'articolo.
- NB: eventuali riordini o aggiunte per completamenti se di quantità inferiore alla minima, saranno fatturati al prezzo normale
- Special prices for the purchase of the minimum quantities indicated (CF) of the article.
- Note Well: any reorders or additions for completions of quantity less than the minimum will be invoiced at the normal price.
- Artikel mit Sonderpreisen bei Mindestabnahmemengen sind mit (CF) gekennzeichnet.
- Nachbestellungen oder Ergänzungen unter der Mindestabnahmemenge werden mit dem Normalpreis verrechnet.

POS.	PROD.	ART.	MIS.	Q.TÀ	FIN.	EURO	
STIPITI SU MURO <i>ALUMINIUM FRAMES / ALUZARGEN</i>							
	P-010					► INDOOR 44	
D. 200		P-010	max 950 x 2500 mm	1 pc	AN	345,30 /pc	
				1 pc	GR	320,30 /pc	
			max 1000 x 2800 mm	1 pc	AN	414,30 /pc	
				1 pc	GR	382,00 /pc	
<ul style="list-style-type: none"> • Obbligatorio comunicare misure H e LS • Please always specify sizes H and LS • Bitte immer Maßen H und LS angeben 							
D. 201		LAV-010	<ul style="list-style-type: none"> • Lavorazione stipite P-010. Obbligatorio completare formulario per quote. • Profiles preparation P-010. Please complete obligatory scheme. • Profilbearbeitung P-010. Bitte obligatorische Formular ausfüllen. 			190,30	
	<p>Fori filettati Threaded holes Gewindebohrungen</p> <p>Fresatura per scrocco Milling for latch Fräsung Schlossfalle</p>		V-037 incluso / included / enthalten				
D. 202		P-011 FIX	1500 mm	1 pc	AN	97,00 /pc	
					GR	91,30 /pc	
			3000 mm	1 pc	AN	151,30 /pc	
					GR	140,30 /pc	
			6000 mm	1 pc	AN	244,70 /pc	
					GR	222,70 /pc	
			P-011 MIS	3000 → 6000 mm	1 pc	AN	274,30 /pc
					GR	252,70 /pc	
SECTOR 4P			3000 mm	4 pcs	AN	108,00 /pc 36,00 /mtl	
			6000 mm	2 pcs	AN	208,00 /pc 34,67 /mtl	
<p>MINIMO D'ORDINE: 8 profili da 6 mt o 16 profili da 3 mt (o multipli), anche assortiti tra i vari modelli, dello stesso settore di magazzino indicato in tabella (SECTOR).</p> <p>MINIMUM ORDER: No. 8 - 6 m profiles, or No. 16 - 3 m profiles, or No. 24 - 2 m profiles (or multiples), also in combination of different models, as long as they belong to the same warehouse sector indicated in the table (SECTOR).</p> <p>MINDESTBESTELLMENGE: 8 Profile mit 6 m oder 16 Profile mit 3 m (nur als Vielfaches), auch sortiert nach den verschiedenen Modellen, aber aus demselben Lagerort, der in der Tabelle angeführt ist (SECTOR).</p>							

- Trasporto fuori standard. Vedi condizioni di vendita
- Non-standard transport. See sales conditions
- Sondertransport. Siehe AGB

POS.	PROD.	ART.	MIS.	Q.TÀ	FIN.	EURO		
D. 203		VP-015			AG	4,70 /mtl		
					NO	6,00 /mtl		
		IVP-015	■ min 100 mtl		AG	4,00 /mtl		
					NO	5,00 /mtl		
		IVP-015-240 mt	■ 240 mtl		AG	2,70 /mtl 648,00 /set		
					NO	3,50 /mtl 840,00 /set		
D. 204		P-034 FIX	1500 mm	1 pc	AN	52,30 /pc		
			3000 mm	1 pc	AN	74,30 /pc		
			6000 mm	1 pc	AN	111,30 /pc		
			P-034 MIS	3000 → 6000 mm	1 pc	AN	134,70 /pc	
		SECTOR 4P	IP-034 ⚠	3000 mm	■ 4 pcs	AN	43,30 /pc 14,43 /mtl	
				6000 mm	■ 2 pcs	AN	79,30 /pc 13,22 /mtl	
		<p>MINIMO D'ORDINE: 8 profili da 6 mt o 16 profili da 3 mt (o multipli ⚠), anche assortiti tra i vari modelli, dello stesso settore di magazzino indicato in tabella (SECTOR).</p> <p>MINIMUM ORDER: No. 8 - 6 m profiles, or No. 16 - 3 m profiles, or No. 24 - 2 m profiles (or multiples ⚠), also in combination of different models, as long as they belong to the same warehouse sector indicated in the table (SECTOR).</p> <p>MINDESTBESTELLMENGE: 8 Profile mit 6 m oder 16 Profile mit 3 m (nur als Vielfaches ⚠), auch sortiert nach den verschiedenen Modellen, aber aus demselben Lagerort, der in der Tabelle angeführt ist (SECTOR).</p>						
		D. 205		P-012-CF4		■ 4 pcs		46,30 /set
		D. 206		V-037		1 pc	IX	11,30 /pc
				V-037-CF10		■ 10 pcs	IX	6,30 /pc









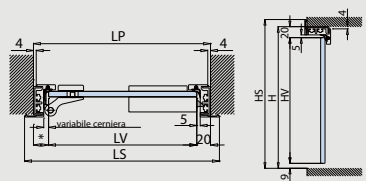
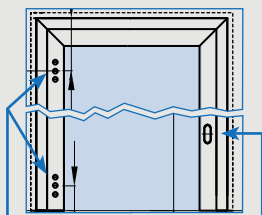

- Confezioni industriali
- Industrial packaging
- Industrieverpackungen

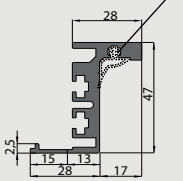

- Confezioni profili con quantità fissa, disponibili solo in multipli della quantità indicata
- Packs of profiles with fixed quantity, available only in multiples of the indicated quantity
- Profilpackungen mit fixer Menge sind nur als Vielfaches der angeführten Menge erhältlich

CF

- Prezzi speciali per l'acquisto delle quantità minime indicate (CF) dell'articolo.
- NB: eventuali riordini o aggiunte per completamenti se di quantità inferiore alla minima, saranno fatturati al prezzo normale
- Special prices for the purchase of the minimum quantities indicated (CF) of the article.
- Note Well: any reorders or additions for completions of quantity less than the minimum will be invoiced at the normal price.
- Artikel mit Sonderpreisen bei Mindestabnahmemengen sind mit (CF) gekennzeichnet.
- Nachbestellungen oder Ergänzungen unter der Mindestabnahmemenge werden mit dem Normalpreis verrechnet.

POS.	PROD.	ART.	MIS.	Q.TÀ	FIN.	EURO		
	P-040					▶ INDOOR 45		
D. 207	 	P-040	max 950 x 2500 mm	1 set	AN	452,30/set		
		<ul style="list-style-type: none"> • Obbligatorio comunicare misure H e LP • Please always specify sizes H and LP • Bitte immer Maßen H und LP angeben 						
D. 208	 Fori filettati Threaded holes Gewindebohrungen Fresatura per scrocco Milling for latch Fräsung Schlossfalle	LAV-040	<ul style="list-style-type: none"> • Lavorazione stipite P-040. Obbligatorio completare formulario per quote. • Profiles preparation P-040. Please complete obligatory scheme. • Profilbearbeitung P-040. Bitte obligatorische Formular ausfüllen. ▶ 537 CP-015  incluso / included / enthalten		2 Cerniere 2 Hinges 2 Bänder		190,30	
					3 Cerniere 3 Hinges 3 Bänder		221,00	
		LAV-040-M	<ul style="list-style-type: none"> • Lavorazione stipite P-040 per serrature magnetiche. • Profiles preparation P-040 for magnetic locks. • Profilbearbeitung P-040 für magnetische Schlösser. CP-015-M  incluso / included / enthalten		2 Cerniere 2 Hinges 2 Bänder		203,30	
					3 Cerniere 3 Hinges 3 Bänder		234,30	
D. 209	 VP-015 not included 	P-041 FIX		1500 mm	1 pc	AN	176,70/pc	
					3000 mm	1 pc	AN	208,00/pc
					6000 mm	1 pc	AN	363,00/pc
		P-041 MIS		3000 → 6000 mm	1 pc	AN	391,30/pc	
		SECTOR 4P	IP-041 		3000 mm	■ 4 pcs	AN	172,30/pc 57,43 /mtl
						6000 mm	■ 2 pcs	AN
<p>MINIMO D'ORDINE: 8 profili da 6 mt o 16 profili da 3 mt (o multipli ), anche assortiti tra i vari modelli, dello stesso settore di magazzino indicato in tabella (SECTOR).</p> <p>MINIMUM ORDER: No. 8 - 6 m profiles, or No. 16 - 3 m profiles, or No. 24 - 2 m profiles (or multiples ), also in combination of different models, as long as they belong to the same warehouse sector indicated in the table (SECTOR).</p> <p>MINDESTBESTELLMENGE: 8 Profile mit 6 m oder 16 Profile mit 3 m (nur als Vielfaches ), auch sortiert nach den verschiedenen Modellen, aber aus demselben Lagerort, der in der Tabelle angeführt ist (SECTOR).</p>								

POS.	PROD.	ART.	MIS.	Q.TÀ	FIN.	EURO		
D. 210		VP-015			AG	4,70 /mtl		
					NO	6,00 /mtl		
		IVP-015		■ min 100 mtl	AG	4,00 /mtl		
					NO	5,00 /mtl		
		IVP-015-240 mt		■ 240 mtl	AG	2,70 /mtl 648,00 /set		
					NO	3,50 /mtl 840,00 /set		
D. 211	OPTIONAL 	P-033 FIX		1500 mm	1 pc	AN 57,70 /pc		
				3000 mm	1 pc	AN 77,50 /pc		
				6000 mm	1 pc	AN 133,30 /pc		
				P-033 MIS	3000 → 6000 mm	1 pc	AN 162,00 /pc	
		SECTOR 4P	IP-033		3000 mm	■ 8 pcs	AN 54,30 /pc 18,10 /mtl	
					6000 mm	■ 4 pcs	AN 100,70 /pc 16,78 /mtl	
		<p>MINIMO D'ORDINE: 8 profili da 6 mt o 16 profili da 3 mt (o multipli), anche assortiti tra i vari modelli, dello stesso settore di magazzino indicato in tabella (SECTOR).</p> <p>MINIMUM ORDER: No. 8 - 6 m profiles, or No. 16 - 3 m profiles, or No. 24 - 2 m profiles (or multiples), also in combination of different models, as long as they belong to the same warehouse sector indicated in the table (SECTOR).</p> <p>MINDESTBESTELLMENGE: 8 Profile mit 6 m oder 16 Profile mit 3 m (nur als Vielfaches), auch sortiert nach den verschiedenen Modellen, aber aus demselben Lagerort, der in der Tabelle angeführt ist (SECTOR).</p>						
		D. 212		P-012-CF4		■ 4 pcs		46,30 /set

- Confezioni industriali
- Industrial packaging
- Industrieverpackungen

- Confezioni profili con quantità fissa, disponibili solo in multipli della quantità indicata
- Packs of profiles with fixed quantity, available only in multiples of the indicated quantity
- Profilpackungen mit fixer Menge sind nur als Vielfaches der angeführten Menge erhältlich

CF

- Prezzi speciali per l'acquisto delle quantità minime indicate (CF) dell'articolo.
- NB: eventuali riordini o aggiunte per completamenti se di quantità inferiore alla minima, saranno fatturati al prezzo normale
- Special prices for the purchase of the minimum quantities indicated (CF) of the article.
- Note Well: any reorders or additions for completions of quantity less than the minimum will be invoiced at the normal price.
- Artikel mit Sonderpreisen bei Mindestabnahmemengen sind mit (CF) gekennzeichnet.
- Nachbestellungen oder Ergänzungen unter der Mindestabnahmemenge werden mit dem Normalpreis verrechnet.

POS.	PROD.	ART.	MIS.	Q.TÀ	FIN.	EURO
TP-300 IMBOTTE						
						▶ INDOOR 48
D. 213		TP-300	max 950 x 2500 mm	1 set	AN	838,50/set
<ul style="list-style-type: none"> • Obbligatorio comunicare misure H e LP • Please always specify sizes H and LP • Bitte immer Maßen H und LP angeben 						
D. 214	<p>Fori filettati Threaded holes Gewindebohrungen</p> <p>Fresatura per scrocco Milling for latch Fräsung Schlossfalle</p>	LAV-TP300	<ul style="list-style-type: none"> • Lavorazione stipite TP-300. Obbligatorio completare formulario per quote. • Profiles preparation TP-300. Please complete obligatory scheme. • Profilbearbeitung TP-300. Bitte obligatorische Formular ausfüllen. <p>▶ 540</p> <p>CP-015 incluso / included / enthalten</p>	2 Cerniere 2 Hinges 2 Bänder		190,30
		LAV-TP300-M	<ul style="list-style-type: none"> • Lavorazione stipite TP-300 per serrature magnetiche. • Profiles preparation TP-300 for magnetic locks. • Profilbearbeitung TP-300 für magnetische Schlösser. <p>CP-015-M incluso / included / enthalten</p>	3 Cerniere 3 Hinges 3 Bänder		221,00
				2 Cerniere 2 Hinges 2 Bänder		203,30
				3 Cerniere 3 Hinges 3 Bänder		234,30
D. 215	<p>VP-315 not included</p>	TP-301 FIX		1500 mm	1 pc	AN 217,30/pc
				3000 mm	1 pc	AN 380,00/pc
			6000 mm	1 pc	AN	702,00/pc



POS.	PROD.	ART.	MIS.	Q.TÀ	FIN.	EURO
D. 216		SECTOR 4P ITP-300-STIPITE	6000 mm	■ 1 pc	AN	386,70 /pc 64,45 /mtl
D. 217		SECTOR 4P ITP-300-COVER	6000 mm	■ 1 pc	AN	186,30 /pc 31,05 /mtl
<p>MINIMO D'ORDINE: 8 profili da 6 mt o 16 profili da 3 mt (o multipli), anche assortiti tra i vari modelli, dello stesso settore di magazzino indicato in tabella (SECTOR).</p> <p>MINIMUM ORDER: No. 8 - 6 m profiles, or No. 16 - 3 m profiles, or No. 24 - 2 m profiles (or multiples), also in combination of different models, as long as they belong to the same warehouse sector indicated in the table (SECTOR).</p> <p>MINDESTBESTELLMENGE: 8 Profile mit 6 m oder 16 Profile mit 3 m (nur als Vielfaches), auch sortiert nach den verschiedenen Modellen, aber aus demselben Lagerort, der in der Tabelle angeführt ist (SECTOR).</p>						
D. 218		P-F18		12 pcs		102,30 /set
		IP-F18		■ min 5 set		97,00 /set
D. 219		VP-315				5,00 /mtl
		IVP-315-CF200		■ 200 mtl		3,17 /mtl 634,50 /set

- Confezioni industriali
- Industrial packaging
- Industrieverpackungen

- Confezioni profili con quantità fissa, disponibili solo in multipli della quantità indicata
- Packs of profiles with fixed quantity, available only in multiples of the indicated quantity
- Profilpackungen mit fixer Menge sind nur als Vielfaches der angeführten Menge erhältlich

CF

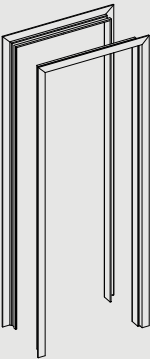
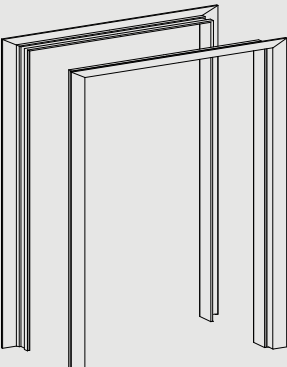
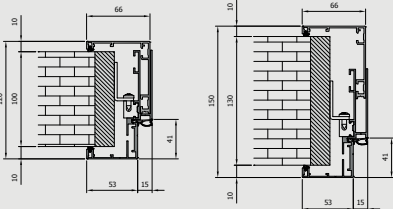
- Prezzi speciali per l'acquisto delle quantità minime indicate (CF) dell'articolo.
- NB: eventuali riordini o aggiunte per completamenti se di quantità inferiore alla minima, saranno fatturati al prezzo normale
- Special prices for the purchase of the minimum quantities indicated (CF) of the article.
- Note Well: any reorders or additions for completions of quantity less than the minimum will be invoiced at the normal price.
- Artikel mit Sonderpreisen bei Mindestabnahmemengen sind mit (CF) gekennzeichnet.
- Nachbestellungen oder Ergänzungen unter der Mindestabnahmemenge werden mit dem Normalpreis verrechnet.

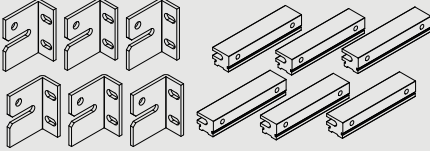
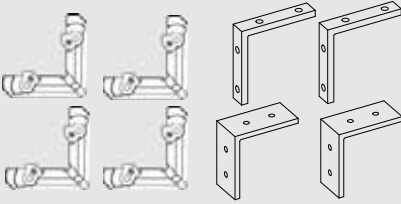
POS.	PROD.	ART.	MIS.	Q.TÀ	FIN.	EURO
TP-250 STIPITI IN ALLUMINIO ALUMINIUM FRAMES / ALUMINIUMZARGEN ▶ INDOOR 49						
D. 220		TP-250 ALUFRAME	max 950 x 2500 mm	1 pc	AN	1178,00 /pc
D. 221		TP-250 2FLG ALUFRAME	max 1900 x 2500 mm	1 pc	AN	1830,00 /pc
D. 222		TP-251 B	 6000 mm	1 pc	AN	137,30 /mtl
D. 223		P-F16		6 pcs	AN	142,00 /set
D. 224		P-F20		8 pcs	AN	98,30 /set

-  Trasporto fuori standard. Vedi condizioni di vendita
- Non-standard transport. See sales conditions
- Sondertransport. Siehe AGB

POS.	PROD.	ART.	MIS.	Q.TÀ	FIN.	EURO
P-080-SL / P-080-V		INDOOR 37 INDOOR 46				
D. 225		P-080-SL	max 950 x 2500 mm	1 set	AN	508,50 /set
		<ul style="list-style-type: none"> • Obligatorio comunicare misure H e LP • Please always specify sizes H and LP • Bitte immer Maßen H und LP angeben 				
D. 226		LAV-080	<ul style="list-style-type: none"> • Lavorazione stipite P-080. Obbligatorio completare formulario per quote. • Profiles preparation P-080. Please complete obligatory scheme. • Profilbearbeitung P-080. Bitte obligatorische Formular ausfüllen. 			190,30
D. 227	<p>Fori filettati Threaded holes Gewindebohrungen</p> <p>Fresatura per scrocco Milling for latch Fräsung Schlossfalle</p>	LAV-080-M	<ul style="list-style-type: none"> • Lavorazione stipite P-080 per serrature magnetiche. • Profiles preparation P-080 for magnetic locks. • Profilbearbeitung P-080 für magnetische Schlösser. 			203,30
D. 228	<p>VP-015 not included</p>	P-081 FIX	3000 mm	1 pc	AN	236,50 /pc
			6000 mm	1 pc	AN	417,70 /pc
		P-081 MIS	3000 → 6000 mm	1 pc	AN	447,50 /pc
		SECTOR 4P				
		IP-081 ⚠	3000 mm	■ 4 pcs	AN	175,70 /pc 58,57 /mtl
			6000 mm	■ 2 pcs	AN	336,70 /pc 56,12 /mtl
<p>MINIMO D'ORDINE: 8 profili da 6 mt o 16 profili da 3 mt (o multipli ⚠), anche assortiti tra i vari modelli, dello stesso settore di magazzino indicato in tabella (SECTOR).</p> <p>MINIMUM ORDER: No. 8 - 6 m profiles, or No. 16 - 3 m profiles, or No. 24 - 2 m profiles (or multiples ⚠), also in combination of different models, as long as they belong to the same warehouse sector indicated in the table (SECTOR).</p> <p>MINDESTBESTELLMENGE: 8 Profile mit 6 m oder 16 Profile mit 3 m (nur als Vielfaches ⚠), auch sortiert nach den verschiedenen Modellen, aber aus demselben Lagerort, der in der Tabelle angeführt ist (SECTOR).</p>						
D. 229		VP-015			AG	4,70 /mtl
					NO	6,00 /mtl
		IVP-015		■ min 100 mtl	AG	4,00 /mtl
					NO	5,00 /mtl
		IVP-015-240 mt		■ 240 mtl	AG	2,70 /mtl 648,00 /set
					NO	3,50 /mtl 840,00 /set

■ Confezioni industriali
• Industrial packaging
• Industrieverpackungen

⚠ Confezioni profili con quantità fissa, disponibili solo in multipli della quantità indicata
• Packs of profiles with fixed quantity, available only in multiples of the indicated quantity
• Profilpackungen mit fixer Menge sind nur als Vielfaches der angeführten Menge erhältlich

CF

• Prezzi speciali per l'acquisto delle quantità minime indicate (CF) dell'articolo.
NB: eventuali riordini o aggiunte per completamenti se di quantità inferiore alla minima, saranno fatturati al prezzo normale
• Special prices for the purchase of the minimum quantities indicated (CF) of the article.
Note Well: any reorders or additions for completions of quantity less than the minimum will be invoiced at the normal price.
• Artikel mit Sonderpreisen bei Mindestabnahmemengen sind mit (CF) gekennzeichnet.
Nachbestellungen oder Ergänzungen unter der Mindestabnahmemenge werden mit dem Normalpreis verrechnet.

POS.	PROD.	ART.	MIS.	Q.TÀ	FIN.	EURO		
D. 230	<p>OPTIONAL</p>	P-033 FIX	1500 mm	1 pc	AN	57,70 /pc		
			3000 mm	1 pc	AN	77,50 /pc		
			6000 mm	1 pc	AN	133,30 /pc		
		SECTOR 4P	P-033 MIS	3000 → 6000 mm	1 pc	AN	162,00 /pc	
				IP-033	3000 mm	■ 8 pcs	AN	54,30 /pc 18,10 /mtl
					6000 mm	■ 4 pcs	AN	100,70 /pc 16,78 /mtl
<p>MINIMO D'ORDINE: 8 profili da 6 mt o 16 profili da 3 mt (o multipli), anche assortiti tra i vari modelli, dello stesso settore di magazzino indicato in tabella (SECTOR). MINIMUM ORDER: No. 8 - 6 m profiles, or No. 16 - 3 m profiles, or No. 24 - 2 m profiles (or multiples), also in combination of different models, as long as they belong to the same warehouse sector indicated in the table (SECTOR). MINDESTBESTELLMENGE: 8 Profile mit 6 m oder 16 Profile mit 3 m (nur als Vielfaches), auch sortiert nach den verschiedenen Modellen, aber aus demselben Lagerort, der in der Tabelle angeführt ist (SECTOR).</p>								
D. 231		P-083		2 pcs		55,30 /set		
		P-083-CF2		■ min 5 set		40,00 /set		
D. 232		CP-015		1 pc		38,50 /pc		
		CP-015 M		1 pc		48,30 /pc		
D. 233		P-082		2 pcs		94,30 /set		
		P-082-CF2		■ min 5 set		76,70 /set		
D. 234		P-084		1 pc		52,50 /pc		
		P-084		■ min 10 pcs		42,30 /pc		
D. 235		B-146	3000 mm	1 pc		32,00 /pc		
		IB-146	3000 mm	■ min 24 pcs		10,00 /set		
		IB-146-CF140	3000 mm	■ 140 pcs		7,74 /pc 1083,50 /set		

- Trasporto fuori standard. Vedi condizioni di vendita
- Non-standard transport. See sales conditions
- Sondertransport. Siehe AGB

POS.	PROD.	ART.	MIS.	Q.TÀ	FIN.	EURO
D. 236		P-088-3	3000 mm	1 pc	AN	117,50 /set
		P-088-6	6000 mm	1 pc	AN	173,50 /set

D. 237		SECTOR 4P	IP-088-A	3000 mm	8 pcs	AN	40,00 /pc 13,33 /mtl
			6000 mm	4 pcs	AN	72,30 /pc 12,05 /mtl	
D. 238		SECTOR 4P	IP-088-B	3000 mm	8 pcs	AN	43,30 /pc 14,43 /mtl
			6000 mm	4 pcs	AN	79,30 /pc 13,22 /mtl	
<p>MINIMO D'ORDINE: 8 profili da 6 mt o 16 profili da 3 mt (o multipli), anche assortiti tra i vari modelli, dello stesso settore di magazzino indicato in tabella (SECTOR).</p> <p>MINIMUM ORDER: No. 8 - 6 m profiles, or No. 16 - 3 m profiles, or No. 24 - 2 m profiles (or multiples), also in combination of different models, as long as they belong to the same warehouse sector indicated in the table (SECTOR).</p> <p>MINDESTBESTELLMENGE: 8 Profile mit 6 m oder 16 Profile mit 3 m (nur als Vielfaches), auch sortiert nach den verschiedenen Modellen, aber aus demselben Lagerort, der in der Tabelle angeführt ist (SECTOR).</p>							

D. 239					
		VP-016	20 mtl	3,14 /mtl 62,70 /pc	
VP-016-CF150		150 mtl	2,75 /mtl 412,00 /pc		
	VP-017	20 mtl	2,27 /mtl 45,30 /pc		
	VP-017-CF250	250 mtl	1,81 /mtl 453,50 /pc		
	VP-019	20 mtl	1,93 /mtl 38,50 /pc		
	VP-019-CF400	400 mtl	1,49 /mtl 596,30 /pc		

- Confezioni industriali
- Industrial packaging
- Industrieverpackungen

- Confezioni profili con quantità fissa, disponibili solo in multipli della quantità indicata
- Packs of profiles with fixed quantity, available only in multiples of the indicated quantity
- Profilpackungen mit fixer Menge sind nur als Vielfaches der angeführten Menge erhältlich

CF

- Prezzi speciali per l'acquisto delle quantità minime indicate (CF) dell'articolo.
- NB: eventuali riordini o aggiunte per completamenti se di quantità inferiore alla minima, saranno fatturati al prezzo normale
- Special prices for the purchase of the minimum quantities indicated (CF) of the article.
- Note Well: any reorders or additions for completions of quantity less than the minimum will be invoiced at the normal price.
- Artikel mit Sonderpreisen bei Mindestabnahmemengen sind mit (CF) gekennzeichnet.
- Nachbestellungen oder Ergänzungen unter der Mindestabnahmemenge werden mit dem Normalpreis verrechnet.

POS.	PROD.	ART.	MIS.	Q.TÀ	FIN.	EURO	
P-085 / P-085-V						▶ INDOOR 38 ▶ INDOOR 47	
D. 240		P-085	max 950 x 2500 mm	1 set	AN	465,50 /set	
							<ul style="list-style-type: none"> • Obligatorio comunicare misure H e LP • Please always specify sizes H and LP • Bitte immer Maßen H und LP angeben
D. 241		P-086 FIX	3000 mm	1 pc	AN	233,30 /pc	
			6000 mm	1 pc	AN	406,00 /pc	
		P-086 MIS	3000 → 6000 mm	1 pc	AN	436,00 /pc	
		SECTOR 4P		3000 mm	■ 4 pcs	AN	157,70 /pc 52,57 /mtl
			IP-086 ⚠	6000 mm	■ 2 pcs	AN	301,30 /pc 50,22 /mtl
<p>MINIMO D'ORDINE: 8 profili da 6 mt o 16 profili da 3 mt (o multipli ⚠), anche assortiti tra i vari modelli, dello stesso settore di magazzino indicato in tabella (SECTOR).</p> <p>MINIMUM ORDER: No. 8 - 6 m profiles, or No. 16 - 3 m profiles, or No. 24 - 2 m profiles (or multiples ⚠), also in combination of different models, as long as they belong to the same warehouse sector indicated in the table (SECTOR).</p> <p>MINDESTBESTELLMENGE: 8 Profile mit 6 m oder 16 Profile mit 3 m (nur als Vielfaches ⚠), auch sortiert nach den verschiedenen Modellen, aber aus demselben Lagerort, der in der Tabelle angeführt ist (SECTOR).</p>							
D. 242		CP-015		1 pc		38,50 /pc	
		CP-015 M		1 pc		48,30 /pc	

- Trasporto fuori standard. Vedi condizioni di vendita
- Non-standard transport. See sales conditions
- Sondertransport. Siehe AGB

POS.	PROD.	ART.	MIS.	Q.TÀ	FIN.	EURO	
D. 243	<p>OPTIONAL</p>	P-033 FIX	1500 mm	1 pc	AN	57,70 /pc	
			3000 mm	1 pc	AN	77,50 /pc	
			6000 mm	1 pc	AN	133,30 /pc	
		SECTOR 4P	P-033 MIS	3000 → 6000 mm	1 pc	AN	162,00 /pc
				3000 mm	■ 8 pcs	AN	54,30 /pc 18,10 /mtl
				6000 mm	■ 4 pcs	AN	100,70 /pc 16,78 /mtl
<p>MINIMO D'ORDINE: 8 profili da 6 mt o 16 profili da 3 mt (o multipli ▲), anche assortiti tra i vari modelli, dello stesso settore di magazzino indicato in tabella (SECTOR). MINIMUM ORDER: No. 8 - 6 m profiles, or No. 16 - 3 m profiles, or No. 24 - 2 m profiles (or multiples ▲), also in combination of different models, as long as they belong to the same warehouse sector indicated in the table (SECTOR). MINDESTBESTELLMENGE: 8 Profile mit 6 m oder 16 Profile mit 3 m (nur als Vielfaches ▲), auch sortiert nach den verschiedenen Modellen, aber aus demselben Lagerort, der in der Tabelle angeführt ist (SECTOR).</p>							
D. 244		P-083		2 pcs		55,30 /set	
		P-083-CF2		■ min 5 set		40,00 /set	
D. 245		P-087		2 pcs		85,00 /set	
		P-087-CF2		■ min 5 set		46,00 /set	
D. 246		IB-146	3000 mm	■ min 24 pcs		10,00 /set	
		IB-146-CF140	3000 mm	■ 140 pcs		7,74 /pc 1083,50 /set	

- Confezioni industriali
- Industrial packaging
- Industrieverpackungen

- ▲ Confezioni profili con quantità fissa, disponibili solo in multipli della quantità indicata
- Packs of profiles with fixed quantity, available only in multiples of the indicated quantity
- Profilpackungen mit fixer Menge sind nur als Vielfaches der angeführten Menge erhältlich

CF

- Prezzi speciali per l'acquisto delle quantità minime indicate (CF) dell'articolo.
- NB: eventuali riordini o aggiunte per completamenti se di quantità inferiore alla minima, saranno fatturati al prezzo normale
- Special prices for the purchase of the minimum quantities indicated (CF) of the article.
- Note Well: any reorders or additions for completions of quantity less than the minimum will be invoiced at the normal price.
- Artikel mit Sonderpreisen bei Mindestabnahmemengen sind mit (CF) gekennzeichnet.
- Nachbestellungen oder Ergänzungen unter der Mindestabnahmemenge werden mit dem Normalpreis verrechnet.

POS.	PROD.	ART.	MIS.	Q.TÀ	FIN.	EURO
D. 247		P-088-3	3000 mm	1 pc	AN	117,50 /set
		P-088-6	6000 mm	1 pc	AN	173,50 /set

D. 248		SECTOR 4P	IP-088-A	3000 mm	8 pcs	AN	40,00 /pc 13,33 /mtl
			6000 mm	4 pcs	AN	72,30 /pc 12,05 /mtl	
D. 249		SECTOR 4P	IP-088-B	3000 mm	8 pcs	AN	43,30 /pc 14,43 /mtl
			6000 mm	4 pcs	AN	79,30 /pc 13,22 /mtl	
<p>MINIMO D'ORDINE: 8 profili da 6 mt o 16 profili da 3 mt (o multipli), anche assortiti tra i vari modelli, dello stesso settore di magazzino indicato in tabella (SECTOR).</p> <p>MINIMUM ORDER: No. 8 - 6 m profiles, or No. 16 - 3 m profiles, or No. 24 - 2 m profiles (or multiples), also in combination of different models, as long as they belong to the same warehouse sector indicated in the table (SECTOR).</p> <p>MINDESTBESTELLMENGE: 8 Profile mit 6 m oder 16 Profile mit 3 m (nur als Vielfaches), auch sortiert nach den verschiedenen Modellen, aber aus demselben Lagerort, der in der Tabelle angeführt ist (SECTOR).</p>							

D. 250					
		VP-016	20 mtl	3,14 /mtl 62,70 /pc	
	VP-016-CF150	150 mtl	2,75 /mtl 412,00 /pc		
	VP-017	20 mtl	2,27 /mtl 45,30 /pc		
	VP-017-CF250	250 mtl	1,81 /mtl 453,50 /pc		
	VP-019	20 mtl	1,93 /mtl 38,50 /pc		
	VP-019-CF400	400 mtl	1,49 /mtl 596,30 /pc		

- Trasporto fuori standard. Vedi condizioni di vendita
- Non-standard transport. See sales conditions
- Sondertransport. Siehe AGB

POS.	PROD.	ART.	MIS.	Q.TÀ	FIN.	EURO
------	-------	------	------	------	------	------

ANTE A SCOMPARSA
FLUSH SLIDING DOORS / SCHIEBETÜREN IN DER WAND LAUFEND



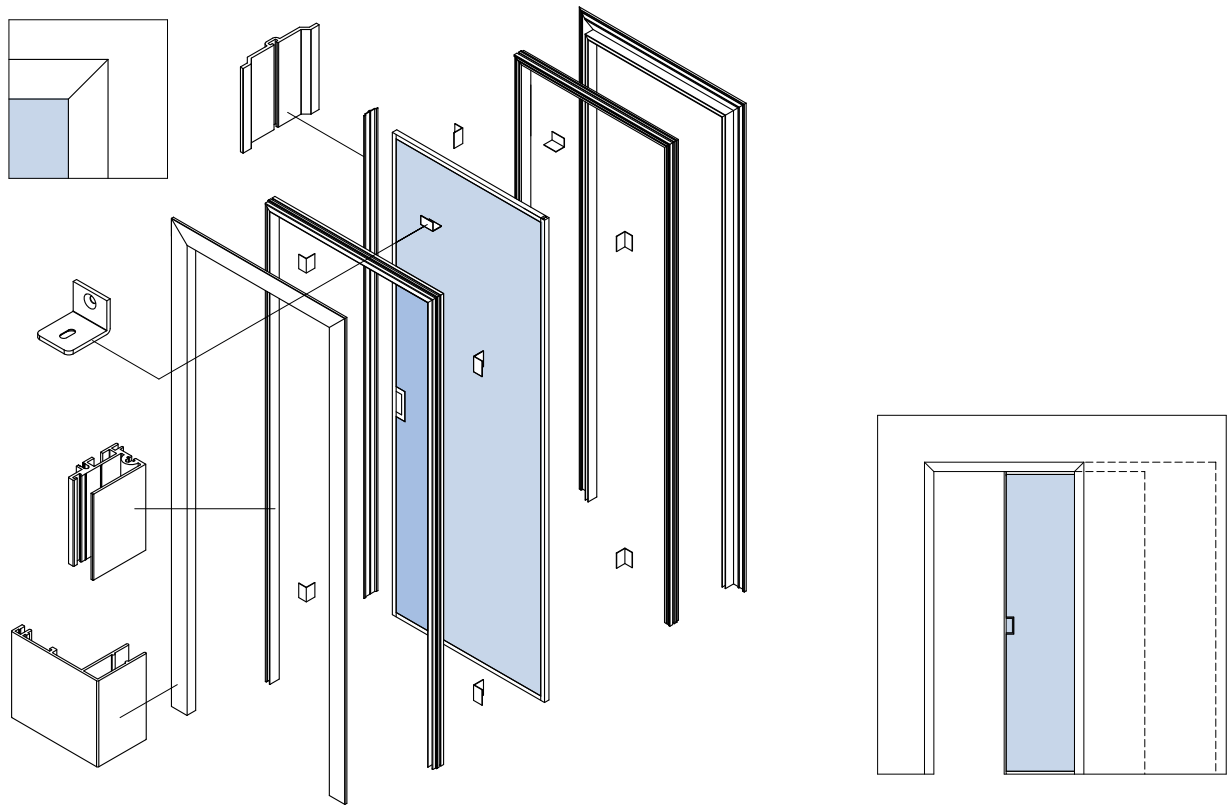







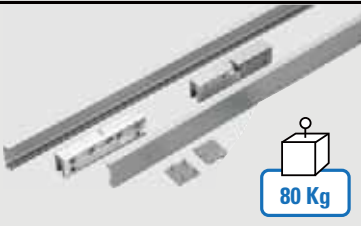

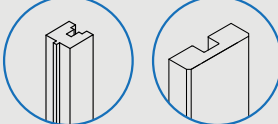

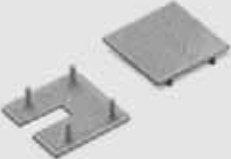
TS-04 ▶ INDOOR 50

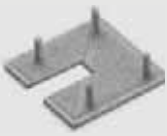

D. 251	TS-04-ANTA VETR	max 1100 x 2150 h	1 pc	AN 1307,30/pc
		max 1300 x 2700 h	1 pc	AN 1611,00/pc
	TS-04-VETR-2FLG	max 2050 x 2150 h	1 pc	AN 1829,00/pc
D. 252	TS-04 ANTA INT	max 1025 x 2150 h	1 pc	AN 1181,30/pc
		max 1300 x 2700 h	1 pc	AN 1445,00/pc
	TS-04-INT-2FLG	max 2050 x 2150 h	1 pc	AN 1666,00/pc

- Confezioni industriali
- Industrial packaging
- Industrieverpackungen

- min**
- Prezzi speciali per l'acquisto delle quantità minime indicate dell'articolo.
NB eventuali riordini o aggiunte per completamenti se di quantità inferiore alla minima, saranno fatturati al prezzo normale
 - Special prices for the purchase of the minimum quantities indicated of the article.
Note Well: any reorders or additions for completions of quantity less than the minimum will be invoiced at the normal price.
 - Artikel mit Sonderpreisen bei Mindestabnahmemengen sind mit gekennzeichnet.
Nachbestellungen oder Ergänzungen unter der Mindestabnahmemenge werden mit dem Normalpreis verrechnet.

POS.	PROD.	ART.	MIS.	Q.TÀ	FIN.	EURO
	V-1664					► INDOOR 52
D. 253		V-1664-1	1000 mm 	1 set	AN	166,50 /set
		V-1664-1,5	1500 mm 	1 set	AN	213,00 /set
D. 254		TS-03		1 set		458,30 /set
D. 255		V-104		1 pc		52,30 /pc
		V-104		■ min 10 pcs		40,70 /pc
				■ min 50 pcs		34,70 /pc
D. 256		V-1668		2 pcs		20,00 /set
D. 257		V-1668-C		2 pcs		20,00 /set
		V-1668-C		■ min 50 pcs		4,00 /pc
D. 258		V-1668-A		■ min 50 pcs		196,30 /pc
D. 259		V-1661-1 	1000 mm	2 pcs	AN	72,50 /2 pc
		V-1661-1,5 	1500 mm	2 pcs	AN	118,50 /2 pc
D. 260		V-1662-3 	3000 mm	■ min 20 pcs	AN	59,00 /pc
		V-1662-6 	 6000 mm	■ min 10 pcs	AN	84,00 /pc

 Trasporto fuori standard. Vedi condizioni di vendita
• Non-standard transport. See sales conditions
• Sondertransport. Siehe AGB

 Tagliato dal cliente
• Cut by installer
• Schnitt bauseitig

POS.	PROD.	ART.	MIS.	Q.TÀ	FIN.	EURO
STIPITI RASOMURO E ANTE IN ALLUMINIO <i>ALIGNED WITH THE WALL FRAMES AND DOORS WITH ALUMINIUM PANEL / WANDBÜNDIGE ALUZARGE UND ALUMIUM FLÜGELRAHMEN</i>						
PO-200 PORTA BATTENTE INTELAIATA <i>DOOR WITH ALUMINIUM PANEL / DREHTÜREN AUS ALUMINIUM</i>						▶ INDOOR 56
D. 261	<p>P-205 P-202 V-122-SD included</p>	PO-200	max 1200 x 3000 h	1 pcs	AN	794,70 /pc
					NO*	+ 30%
D. 262		P-F25		1 set		86,00 /set
		IP-F25		■ min 5 sets		70,30 /set
D. 263		P-205		1 pcs	AN	75,70 /mtl
		P-205 B	6000 mm	1 pcs	AN	64,30 /mtl
					NO*	+ 30%
		SECTOR 4P				
		IP-205	3000 mm	■ 4 pcs	AN	122,00 /pc 40,67 /mtl
			6000 mm	■ 2 pcs	AN	236,50 /pc 39,42 /mtl
		MINIMO D'ORDINE: 8 profili da 6 mt o 16 profili da 3 mt (o multipli), anche assortiti tra i vari modelli, dello stesso settore di magazzino indicato in tabella (SECTOR). MINIMUM ORDER: No. 8 - 6 m profiles, or No. 16 - 3 m profiles, or No. 24 - 2 m profiles (or multiples), also in combination of different models, as long as they belong to the same warehouse sector indicated in the table (SECTOR). MINDESTBESTELLMENGE: 8 Profile mit 6 m oder 16 Profile mit 3 m (nur als Vielfaches), auch sortiert nach den verschiedenen Modellen, aber aus demselben Lagerort, der in der Tabelle angeführt ist (SECTOR).				

- Confezioni industriali
- Industrial packaging
- Industrieverpackungen

- Confezioni profili con quantità fissa, disponibili solo in multipli della quantità indicata
- Packs of profiles with fixed quantity, available only in multiples of the indicated quantity
- Profilpackungen mit fixer Menge sind nur als Vielfaches der angeführten Menge erhältlich

CF

- Prezzi speciali per l'acquisto delle quantità minime indicate (CF) dell'articolo.
- NB: eventuali riordini o aggiunte per completamenti se di quantità inferiore alla minima, saranno fatturati al prezzo normale
- Special prices for the purchase of the minimum quantities indicated (CF) of the article.
- Note Well: any reorders or additions for completions of quantity less than the minimum will be invoiced at the normal price.
- Artikel mit Sonderpreisen bei Mindestabnahmemengen sind mit (CF) gekennzeichnet.
- Nachbestellungen oder Ergänzungen unter der Mindestabnahmemenge werden mit dem Normalpreis verrechnet.

POS.	PROD.	ART.	MIS.	Q.TÀ	FIN.	EURO	
D. 264		P-202		1 pc	AN	81,70 /mtl	
		P-202 B	6000 mm	1 pc	AN	68,50 /mtl	
					NO*	+ 30%	
		SECTOR 4P	IP-202	3000 mm	■ 4 pcs	AN	147,30 /pc 49,10 /mtl
				6000 mm	■ 2 pcs	AN	286,70 /pc 47,78 /mtl
<p>MINIMO D'ORDINE: 8 profili da 6 mt o 16 profili da 3 mt (o multipli), anche assortiti tra i vari modelli, dello stesso settore di magazzino indicato in tabella (SECTOR).</p> <p>MINIMUM ORDER: No. 8 - 6 m profiles, or No. 16 - 3 m profiles, or No. 24 - 2 m profiles (or multiples), also in combination of different models, as long as they belong to the same warehouse sector indicated in the table (SECTOR).</p> <p>MINDESTBESTELLMENGE: 8 Profile mit 6 m oder 16 Profile mit 3 m (nur als Vielfaches), auch sortiert nach den verschiedenen Modellen, aber aus demselben Lagerort, der in der Tabelle angeführt ist (SECTOR).</p>							
D. 265		V-122-SD		1 pair		102,30 /pair	
		IV-122-SD		■ min 5 sets		54,70 /set	
D. 266		MV-790 PZ		1 pc	CP	377,00 /pc	
		C-010		1 pc	CR	28,00 /pc	
		C-011		1 pc	CP	62,00 /pc	
		C-012		1 pc	CP	68,30 /pc	
D. 267		V-791 PZ		1 pc	CP NO	189,30 /pc	
		MV-791 PZ		1 pc	CP NO	326,00 /pc	
		C-06		1 pc	CR	29,70 /pc	
D. 268		P-204-CF2	1160 mm	2 pcs	AN	156,70 /set 78,35 /pc	
		SECTOR 4P	IP-204	3000 mm	■ 8 pcs	AN	57,70 /pc 19,23 /mtl
				6000 mm	■ 4 pcs	AN	108,00 /pc 18,00 /mtl
<p>MINIMO D'ORDINE: 8 profili da 6 mt o 16 profili da 3 mt (o multipli), anche assortiti tra i vari modelli, dello stesso settore di magazzino indicato in tabella (SECTOR).</p> <p>MINIMUM ORDER: No. 8 - 6 m profiles, or No. 16 - 3 m profiles, or No. 24 - 2 m profiles (or multiples), also in combination of different models, as long as they belong to the same warehouse sector indicated in the table (SECTOR).</p> <p>MINDESTBESTELLMENGE: 8 Profile mit 6 m oder 16 Profile mit 3 m (nur als Vielfaches), auch sortiert nach den verschiedenen Modellen, aber aus demselben Lagerort, der in der Tabelle angeführt ist (SECTOR).</p>							



- Trasporto fuori standard. Vedi condizioni di vendita
- Non-standard transport. See sales conditions
- Sondertransport. Siehe AGB



- Tagliato dal cliente
- Cut by installer
- Schnitt bauseitig

NO* Nero opaco - Matt black - Schwarz matt

- Disponibilità da verificare con ufficio commerciale
- Available to be checked with sales office
- Die Verfügbarkeit ist mit dem Verkaufsbüro abzustimmen



- Tagliato a misura del cliente
- Custom length
- Nach Mass geschnitten











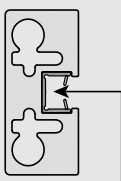



POS.	PROD.	ART.	MIS.	Q.TÀ	FIN.	EURO
PO-100 PORTA BATTENTE INTELAIATA DOOR WITH ALUMINIUM PANEL / DREHTÜREN AUS ALUMINIUM						▶ INDOOR 58
D. 269		PO-100	L = 0 → 60 cm	h max 210	1 pc	AN 624,30 /pc
				h 210 → 240	1 pc	AN 644,00 /pc
				h 240 → 270	1 pc	AN 671,00 /pc
				h 270 → 300	1 pc	AN 695,70 /pc
			L = 60 → 90 cm	h max 210	1 pc	AN 644,00 /pc
				h 210 → 240	1 pc	AN 671,00 /pc
				h 240 → 270	1 pc	AN 695,70 /pc
				h 270 → 300	1 pc	AN 718,50 /pc
			L = 90 → 120 cm	h max 210	1 pc	AN 671,00 /pc
				h 210 → 240	1 pc	AN 695,70 /pc
				h 240 → 270	1 pc	AN 718,50 /pc
				h 270 → 300	1 pc	AN 739,00 /pc
D. 270		V-710		1 pc	232,30 /pc	
D. 271		V-760 PZ		1 pc	268,50 /pc	
D. 272	<p>IVP-101-GUARN</p>	P-101		1 pc	AN 85,00 /mtl	
		P-101 B	6000 mm	1 pc	AN 64,70 /mtl	
		SECTOR 4P IP-101 (IVP-101-GUARN not included)	3000 mm	4 pcs	AN 129,50 /pc 43,17 /mtl	
			6000 mm	2 pcs	AN 236,50 /pc 39,42 /mtl	
		<p>MINIMO D'ORDINE: 8 profili da 6 mt o 16 profili da 3 mt (o multipli), anche assortiti tra i vari modelli, dello stesso settore di magazzino indicato in tabella (SECTOR).</p> <p>MINIMUM ORDER: No. 8 - 6 m profiles, or No. 16 - 3 m profiles, or No. 24 - 2 m profiles (or multiples), also in combination of different models, as long as they belong to the same warehouse sector indicated in the table (SECTOR).</p> <p>MINDESTBESTELLMENGE: 8 Profile mit 6 m oder 16 Profile mit 3 m (nur als Vielfaches), auch sortiert nach den verschiedenen Modellen, aber aus demselben Lagerort, der in der Tabelle angeführt ist (SECTOR).</p>				

- Confezioni industriali
- Industrial packaging
- Industrieverpackungen

- Confezioni profili con quantità fissa, disponibili solo in multipli della quantità indicata
- Packs of profiles with fixed quantity, available only in multiples of the indicated quantity
- Profilpackungen mit fixer Menge sind nur als Vielfaches der angeführten Menge erhältlich

- Trasporto fuori standard. Vedi condizioni di vendita
- Non-standard transport. See sales conditions
- Sondertransport. Siehe AGB

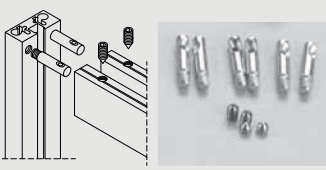
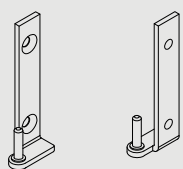
- Tagliato a misura del cliente
- Custom length
- Nach Mass geschnitten

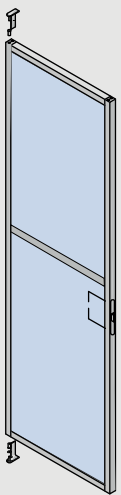
POS.	PROD.	ART.	MIS.	Q.TÀ	FIN.	EURO	
D. 273	 IVP-101-GUARN	P-102		1 pc	AN	85,00 /mtl	
		P-102 B	 6000 mm	1 pc	AN	65,00 /mtl	
		SECTOR 4P IP-102  (IVP-101-GUARN not included)	3000 mm	 4 pcs	AN	122,00 /pc 40,67 /mtl	
			 6000 mm	 2 pcs	AN	229,00 /pc 38,17 /mtl	
<p>MINIMO D'ORDINE: 8 profili da 6 mt o 16 profili da 3 mt (o multipli ), anche assortiti tra i vari modelli, dello stesso settore di magazzino indicato in tabella (SECTOR).</p> <p>MINIMUM ORDER: No. 8 - 6 m profiles, or No. 16 - 3 m profiles, or No. 24 - 2 m profiles (or multiples ), also in combination of different models, as long as they belong to the same warehouse sector indicated in the table (SECTOR).</p> <p>MINDESTBESTELLMENGE: 8 Profile mit 6 m oder 16 Profile mit 3 m (nur als Vielfaches ), auch sortiert nach den verschiedenen Modellen, aber aus demselben Lagerort, der in der Tabelle angeführt ist (SECTOR).</p>							
D. 274		IVP-101-GUARN	3400 mm	 min 20 pcs		10,30 /pc	
D. 275		PF-05		1 set		10,30 /set	
D. 276		V-120-SD		1 pair		72,50 /pair	
		IV-120-SD		 min 5 pairs		56,50 /pair	
D. 277		PO-101	L = 0 → 60 cm	h max 210	1 pc	AN	785,50 /pc
				h 210 → 240	1 pc	AN	805,70 /pc
				h 240 → 270	1 pc	AN	831,00 /pc
				h 270 → 300	1 pc	AN	855,50 /pc
			L = 60 → 90 cm	h max 210	1 pc	AN	817,00 /pc
				h 210 → 240	1 pc	AN	841,00 /pc
				h 240 → 270	1 pc	AN	866,50 /pc
			L = 90 → 120 cm	h 270 → 300	1 pc	AN	891,30 /pc
				h max 210	1 pc	AN	852,30 /pc
				h 210 → 240	1 pc	AN	880,00 /pc
				h 240 → 270	1 pc	AN	905,00 /pc
				h 270 → 300	1 pc	AN	928,30 /pc

POS.	PROD.	ART.	MIS.	Q.TÀ	FIN.	EURO
D. 278		PO-102	L = 0 → 60 cm	h max 210	1 pc	AN 855,50 /pc
				h 210 → 240	1 pc	AN 880,00 /pc
				h 240 → 270	1 pc	AN 904,50 /pc
				h 270 → 300	1 pc	AN 958,00 /pc
			L = 60 → 90 cm	h max 210	1 pc	AN 905,00 /pc
				h 210 → 240	1 pc	AN 928,30 /pc
				h 240 → 270	1 pc	AN 953,70 /pc
				h 270 → 300	1 pc	AN 979,00 /pc
			L = 90 → 120 cm	h max 210	1 pc	AN 953,70 /pc
				h 210 → 240	1 pc	AN 978,70 /pc
				h 240 → 270	1 pc	AN 991,30 /pc
				h 270 → 300	1 pc	AN 1027,50 /pc
D. 279		PO-103	L = 0 → 60 cm	h max 210	1 pc	AN 930,00 /pc
				h 210 → 240	1 pc	AN 953,70 /pc
				h 240 → 270	1 pc	AN 979,00 /pc
				h 270 → 300	1 pc	AN 1004,30 /pc
			L = 60 → 90 cm	h max 210	1 pc	AN 991,30 /pc
				h 210 → 240	1 pc	AN 1015,30 /pc
				h 240 → 270	1 pc	AN 1040,30 /pc
				h 270 → 300	1 pc	AN 1065,30 /pc
			L = 90 → 120 cm	h max 210	1 pc	AN 1051,70 /pc
				h 210 → 240	1 pc	AN 1076,50 /pc
				h 240 → 270	1 pc	AN 1101,50 /pc
				h 270 → 300	1 pc	AN 1126,50 /pc
D. 280		P-104		1 pc	AN 93,00 /mtl	
		P-104 B	6000 mm	1 pc	AN 71,30 /mtl	
		SECTOR 4P	3000 mm	4 pcs	AN 118,50 /pc 39,50 /mtl	
			IP-104 (IVP-101-GUARN not included)	6000 mm	2 pcs	AN 229,00 /pc 38,17 /mtl
			<p>MINIMO D'ORDINE: 8 profili da 6 mt o 16 profili da 3 mt (o multipli), anche assortiti tra i vari modelli, dello stesso settore di magazzino indicato in tabella (SECTOR).</p> <p>MINIMUM ORDER: No. 8 - 6 m profiles, or No. 16 - 3 m profiles, or No. 24 - 2 m profiles (or multiples), also in combination of different models, as long as they belong to the same warehouse sector indicated in the table (SECTOR).</p> <p>MINDESTBESTELLMENGE: 8 Profile mit 6 m oder 16 Profile mit 3 m (nur als Vielfaches), auch sortiert nach den verschiedenen Modellen, aber aus demselben Lagerort, der in der Tabelle angeführt ist (SECTOR).</p>			

- Confezioni industriali
- Industrial packaging
- Industrieverpackungen

- Confezioni profili con quantità fissa, disponibili solo in multipli della quantità indicata
- Packs of profiles with fixed quantity, available only in multiples of the indicated quantity
- Profilpackungen mit fixer Menge sind nur als Vielfaches der angeführten Menge erhältlich

- Trasporto fuori standard. Vedi condizioni di vendita
- Non-standard transport. See sales conditions
- Sondertransport. Siehe AGB

POS.	PROD.	ART.	MIS.	Q.TÀ	FIN.	EURO				
PO-290 BRIXIA PORTA SCORREVOLE INTELAIATA <i>SLIDING DOOR WITH ALUMINIUM PANEL / SCHIEBETÜR AUS ALUMINIUM</i> ▶ SCORREVOLI 55										
A. 281		PO-290-BRIXIA	max LM 1200 mm x HM 3000 mm	1 set	AN	636,50 /set				
					NO	763,70 /set				
A. 282		PO-292-TS4	max 1200 x 3000 mm	1 set	AN	144,70 /set				
					IPO-292-TS4	max 1200 x 3000 mm	■ min 5 set	AN	126,30 /set	
A. 283		P-203 MIS		1 pc	AN	90,00 /mtl				
					SECTOR 4P	IP-203	3000 mm	■ 4 pcs	AN	117,50 /pc 39,17 /mtl
							6000 mm	■ 2 pcs	AN	227,30 /pc 37,88 /mtl
<p>MINIMO D'ORDINE: 8 profili da 6 mt o 16 profili da 3 mt (o multipli ▲), anche assortiti tra i vari modelli, dello stesso settore di magazzino indicato in tabella (SECTOR).</p> <p>MINIMUM ORDER: No. 8 - 6 m profiles, or No. 16 - 3 m profiles, or No. 24 - 2 m profiles (or multiples ▲), also in combination of different models, as long as they belong to the same warehouse sector indicated in the table (SECTOR).</p> <p>MINDESTBESTELLMENGE: 8 Profile mit 6 m oder 16 Profile mit 3 m (nur als Vielfaches ▲), auch sortiert nach den verschiedenen Modellen, aber aus demselben Lagerort, der in der Tabelle angeführt ist (SECTOR).</p>										
A. 284		SECTOR 4P	IP-203 VELETTA		AN	52,00 /pc 17,33 /mtl				
					3000 mm	■ 16 pcs	AN	90,00 /pc 15,00 /mtl		
					6000 mm	8 pcs	AN	90,00 /pc 15,00 /mtl		
<p>MINIMO D'ORDINE: 8 profili da 6 mt o 16 profili da 3 mt (o multipli ▲), anche assortiti tra i vari modelli, dello stesso settore di magazzino indicato in tabella (SECTOR).</p> <p>MINIMUM ORDER: No. 8 - 6 m profiles, or No. 16 - 3 m profiles, or No. 24 - 2 m profiles (or multiples ▲), also in combination of different models, as long as they belong to the same warehouse sector indicated in the table (SECTOR).</p> <p>MINDESTBESTELLMENGE: 8 Profile mit 6 m oder 16 Profile mit 3 m (nur als Vielfaches ▲), auch sortiert nach den verschiedenen Modellen, aber aus demselben Lagerort, der in der Tabelle angeführt ist (SECTOR).</p>										

- Tagliato dal cliente
- Cut by installer
- Schnitt bauseitig

- Maniglia da ordinare a parte
- Handle to order separately
- Schiebegriffe nicht inkl.
- Custom length
- Nach Mass geschnitten

NO* Nero opaco - Matt black - Schwarz matt

- Disponibilità da verificare con ufficio commerciale
- Available to be checked with sales office
- Die Verfügbarkeit ist mit dem Verkaufsbüro abzustimmen

POS.	PROD.	ART.	MIS.	Q.TÀ	FIN.	EURO	
D. 285		P-205		1 pc	AN	75,70 /mtl	
		P-205 B	6000 mm	1 pc	AN	64,30 /mtl	
					NO*	+ 30%	
		SECTOR 4P		3000 mm	4 pcs	AN	122,00 /pc 40,67 /mtl
				6000 mm	2 pcs	AN	236,50 /pc 39,42 /mtl
<p>MINIMO D'ORDINE: 8 profili da 6 mt o 16 profili da 3 mt (o multipli), anche assortiti tra i vari modelli, dello stesso settore di magazzino indicato in tabella (SECTOR).</p> <p>MINIMUM ORDER: No. 8 - 6 m profiles, or No. 16 - 3 m profiles, or No. 24 - 2 m profiles (or multiples), also in combination of different models, as long as they belong to the same warehouse sector indicated in the table (SECTOR).</p> <p>MINDESTBESTELLMENGE: 8 Profile mit 6 m oder 16 Profile mit 3 m (nur als Vielfaches), auch sortiert nach den verschiedenen Modellen, aber aus demselben Lagerort, der in der Tabelle angeführt ist (SECTOR).</p>							
D. 286		P-202		1 pc	AN	81,70 /mtl	
		P-202 B	6000 mm	1 pc	AN	68,50 /mtl	
					NO*	+ 30%	
		SECTOR 4P		3000 mm	4 pcs	AN	147,30 /pc 49,10 /mtl
				6000 mm	2 pcs	AN	286,70 /pcs 47,78 /mtl
<p>MINIMO D'ORDINE: 8 profili da 6 mt o 16 profili da 3 mt (o multipli), anche assortiti tra i vari modelli, dello stesso settore di magazzino indicato in tabella (SECTOR).</p> <p>MINIMUM ORDER: No. 8 - 6 m profiles, or No. 16 - 3 m profiles, or No. 24 - 2 m profiles (or multiples), also in combination of different models, as long as they belong to the same warehouse sector indicated in the table (SECTOR).</p> <p>MINDESTBESTELLMENGE: 8 Profile mit 6 m oder 16 Profile mit 3 m (nur als Vielfaches), auch sortiert nach den verschiedenen Modellen, aber aus demselben Lagerort, der in der Tabelle angeführt ist (SECTOR).</p>							
D. 287		PO-292-BRIXIA		1 pc	AN	160,00 /mtl	
		IPO-292-BRIXIA		min 5 set	AN	130,00 /set	

- Confezioni industriali
- Industrial packaging
- Industrieverpackungen

- Confezioni profili con quantità fissa, disponibili solo in multipli della quantità indicata
- Packs of profiles with fixed quantity, available only in multiples of the indicated quantity
- Profilpackungen mit fixer Menge sind nur als Vielfaches der angeführten Menge erhältlich

CF

- Prezzi speciali per l'acquisto delle quantità minime indicate (CF) dell'articolo.
- NB: eventuali riordini o aggiunte per completamenti se di quantità inferiore alla minima, saranno fatturati al prezzo normale
- Special prices for the purchase of the minimum quantities indicated (CF) of the article.
- Note Well: any reorders or additions for completions of quantity less than the minimum will be invoiced at the normal price.
- Artikel mit Sonderpreisen bei Mindestabnahmemengen sind mit (CF) gekennzeichnet.
- Nachbestellungen oder Ergänzungen unter der Mindestabnahmemenge werden mit dem Normalpreis verrechnet.

POS.	PROD.	ART.	MIS.	Q.TÀ	FIN.	EURO	
D. 288	<p>Biadesivo Self-adhesive Klebestreifen</p>	P-204-CF2	1160 mm	2 pcs	AN	156,70 /set 78,35 /pcs	
		SECTOR 4P	IP-204	3000 mm	■ 8 pcs	AN	57,70 /pc 19,23 /mtl
			6000 mm	■ 4 pcs	AN	108,00 /pc 18,00 /mtl	
<p>MINIMO D'ORDINE: 8 profili da 6 mt o 16 profili da 3 mt (o multipli), anche assortiti tra i vari modelli, dello stesso settore di magazzino indicato in tabella (SECTOR).</p> <p>MINIMUM ORDER: No. 8 - 6 m profiles, or No. 16 - 3 m profiles, or No. 24 - 2 m profiles (or multiples), also in combination of different models, as long as they belong to the same warehouse sector indicated in the table (SECTOR).</p> <p>MINDESTBESTELLMENGE: 8 Profile mit 6 m oder 16 Profile mit 3 m (nur als Vielfaches), auch sortiert nach den verschiedenen Modellen, aber aus demselben Lagerort, der in der Tabelle angeführt ist (SECTOR).</p>							
D. 289		P-F25		1 set		86,00 /set	
		IP-F25		■ min 5 set		70,30 /set	
D. 290		PO-292-TS4		1 set		144,70 /set	
		IPO-292-TS4		■ 5 set	AN	126,30 /set	
D. 291		F-007		1 pair	AN	86,30 /pair	
		IF-007		■ min 5 pairs	AN	61,00 /pair	













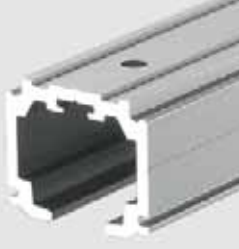

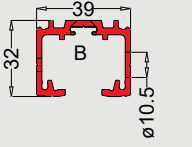

- Trasporto fuori standard. Vedi condizioni di vendita
- Non-standard transport. See sales conditions
- Sondertransport. Siehe AGB



- Tagliato a misura del cliente
- Custom length
- Nach Mass geschnitten

NO* Nero opaco - Matt black - Schwarz matt

- Disponibilità da verificare con ufficio commerciale
- Available to be checked with sales office
- Die Verfügbarkeit ist mit dem Verkaufsbüro abzustimmen

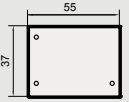
POS.	PROD.	ART.	MIS.	Q.TÀ	FIN.	EURO	FIN.	EURO
D. 292		V-1860	2000 mm	1 pc	AN	117,00 /pc		
			3000 mm	1 pc	AN	160,50 /pc		
			4000 mm	1 pc	AN	204,30 /pc		
			 6000 mm	1 pc	AN	288,70 /pc		
			1500 → 3000 mm	1 pc	AN	186,30 /pc		
			3000 → 6000 mm	1 pc	AN	366,30 /pc		
D. 292		IV-1860 	3000 mm	■ 4 pcs	AN	120,50 /pc 40,17 /mtl		
			6000 mm	■ 2 pcs	AN	236,30 /pc 39,38 /mtl		
D. 293		CLIPS-BRIXIA	(2 pcs/m)	■ 12 pcs		19,30 /set 1,61 /pc		
D. 294		V-1827	2000 mm	1 pc	AN	62,70 /pc	NO	81,30 /pc
			3000 mm	1 pc	AN	80,00 /pc	NO	104,00 /pc
			4000 mm	1 pc	AN	105,30 /pc	NO	137,30 /pc
			 6000 mm	1 pc	AN	173,00 /pc	NO	224,50 /pc
			1500 → 3000 mm	1 pc	AN	140,30 /pc	NO	182,70 /pc
			3000 → 6000 mm	1 pc	AN	235,50 /pc	NO	306,00 /pc
D. 295		IV-1827 	3000 mm	■ 16 pcs	AN	62,70 /pc 20,90 /mtl	NO	85,00 /pc 28,33 /mtl
			6000 mm	■ 8 pcs	AN	116,00 /pc 19,33 /mtl	NO	161,50 /pc 26,92 /mtl
<p>MINIMO D'ORDINE: 8 profili da 6 mt o 16 profili da 3 mt (o multipli ), anche assortiti tra i vari modelli, dello stesso settore di magazzino indicato in tabella (SECTOR).</p> <p>MINIMUM ORDER: No. 8 - 6 m profiles, or No. 16 - 3 m profiles, or No. 24 - 2 m profiles (or multiples ), also in combination of different models, as long as they belong to the same warehouse sector indicated in the table (SECTOR).</p> <p>MINDESTBESTELLMENGE: 8 Profile mit 6 m oder 16 Profile mit 3 m (nur als Vielfaches ), auch sortiert nach den verschiedenen Modellen, aber aus demselben Lagerort, der in der Tabelle angeführt ist (SECTOR).</p>								
D. 296		V-1829-CF2	2000 mm	2 pcs		83,00 /2 pcs	NO	108,00 /2 pcs
			3000 mm	2 pcs		109,50 /2 pcs	NO	142,70 /2 pcs
			4000 mm	2 pcs		135,70 /2 pcs	NO	176,30 /2 pcs
			 6000 mm	2 pcs		181,70 /2 pcs	NO	236,30 /2 pcs
			1500 → 3000 mm	2 pcs		153,50 /2 pcs	NO	198,70 /2 pcs
			3000 → 6000 mm	2 pcs		247,30 /2 pcs	NO	321,50 /2 pcs
<ul style="list-style-type: none"> • Velella vendibile solo con binario di pari lunghezza, se acquistata sciolta va calcolata una maggiorazione di € 30,00 per ogni imballo. • Cover profile available only packed with rail profile. For profiles supplied without rails the extra cost for each package unit is € 30,00. • Profilabdeckung lieferbar nur mit Laufschiene verpackt. Aufpreis für Profilabdeckungen ohne Laufschiene ist € 30,00 pro Verpackungseinheit 								
D. 297		V-1818-P		2 pcs	AN	23,00 /set	NO	30,50 /set
		V-1818-P		■ min 10 set	AN	19,70 /set	NO	24,70 /set

- Confezioni industriali
- Industrial packaging
- Industrieverpackungen

-  Confezioni profili con quantità fissa, disponibili solo in multipli della quantità indicata
- Packs of profiles with fixed quantity, available only in multiples of the indicated quantity
- Profilpackungen mit fixer Menge sind nur als Vielfaches der angeführten Menge erhältlich

CF

- Prezzi speciali per l'acquisto delle quantità minime indicate (CF) dell'articolo.
- NB: eventuali riordini o aggiunte per completamenti se di quantità inferiore alla minima, saranno fatturati al prezzo normale
- Special prices for the purchase of the minimum quantities indicated (CF) of the article.
- Note Well: any reorders or additions for completions of quantity less than the minimum will be invoiced at the normal price.
- Artikel mit Sonderpreisen bei Mindestabnahmemengen sind mit (CF) gekennzeichnet.
- Nachbestellungen oder Ergänzungen unter der Mindestabnahmemenge werden mit dem Normalpreis verrechnet.

POS.	PROD.	ART.	MIS.	Q.TÀ	FIN.	EURO		
P-060 STIPITI RASOMURO ALIGNED WITH THE WALL FRAMES / WANDBÜNDIGE ALUZARGE ▶ INDOOR 60								
D. 298	<p>LFM larghezza foro muratura LS larghezza stipite LP larghezza passaggio luce</p> <p>LFM = LP + 202 HFM = LP + 101</p>	<p>HP passaggio luce HA altezza anta vetro HS altezza stipite HFM altezza foro muratura</p>	<ul style="list-style-type: none"> • Applicazione su muratura • Application to the wall • Zum Einmauern 		<ul style="list-style-type: none"> • A - tirare a sinistra • A - left opening to pull • A - Links nach aussen öffnend • B - tirare a destra • B - right opening to pull • B - Recht nach aussen öffnend 	P-060	1 pc	AN 1051,70 /pc
D. 299	<p>Fori filettati Threaded holes Gewindebohrungen</p> <p>Fresatura per scrocco Milling for latch Fräsung Schlossfalle</p>	LAV-060	<ul style="list-style-type: none"> • Lavorazione stipite P-060. Obbligatorio completare formulario per quote. • Profiles preparation P-060. Please complete obligatory scheme. • Profilbearbeitung P-060. Bitte obligatorische Formular ausfüllen. <p>▶ 544</p> <p>CP-015 incluso / included / enthalten</p>	246,70				
D. 300		P-062		6 pcs	253,70 /set			
D. 301		P-061		1 pc	101,30 /mtl			
		P-061 B	6000 mm	1 pc	87,30 /mtl			
D. 302		P-F21		1 set	61,00 /set			
D. 303		P-063	2800 mm	4 pcs	73,30 /set			

POS.	PROD.	ART.	MIS.	Q.TÀ	FIN.	EURO
------	-------	------	------	------	------	------

P-070 STIPITI RASOMURO
ALIGNED WITH THE WALL FRAMES / WANDBÜNDIGE ALUZARGE ▶ INDOOR 61

D. 304

LFM larghezza foro muratura
LS larghezza stipite
LP larghezza passaggio luce

HP passaggio luce
HA altezza antra vetro
HS altezza stipite
HFM altezza foro muratura

$LFM = LP + 202$
 $HFM = LP + 101$

- Applicazione su muratura
- Application to the wall
- Zum Einmauern

- **A** - tirare a sinistra
- **A** - left opening to pull
- **A** - Links nach aussen öffnend
- **B** - tirare a destra
- **B** - right opening to pull
- **B** - Recht nach aussen öffnend

D. 305

LAV-070

- Lavorazione stipite P-060. Obbligatorio completare formulario per quote.
- Profiles preparation P-060. Please complete obligatory scheme.
- Profilbearbeitung P-060. Bitte obligatorische Formular ausfüllen.

▶ 545

CP-015 incluso / included / enthalten

246,70

D. 306

P-072

6 pcs

253,70/set

D. 307

P-071 1 pc 101,30 /mtl

P-071 B 6000 mm 1 pc 87,30 /mtl

D. 308

P-F21

1 set 61,00/set

D. 309

P-063

2800 mm 4 pcs 73,30/set

- Trasporto fuori standard. Vedi condizioni di vendita
- Non-standard trasport. See sales conditions
- Sondertransport. Siehe AGB
- Tagliato a misura del cliente
- Custom length
- Nach Mass geschnitten

GUIDA TECNICA PER LA SCELTA DEL VOSTRO SISTEMA
TECHNICAL GUIDE FOR THE CHOICE OF YOUR SYSTEM
AUSWAHL VON SYSTEME NACH VORHANDENEN KRITERIEN

SERRATURE ORIZZONTALI PER PORTE BATTENTI
HORIZONTAL LOCKS FOR SWING DOORS
HORIZONTALE SCHLÖSSER FÜR DREH-TÜREN

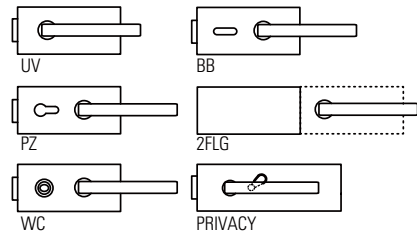

V-230
BASIC ROUND

▶ 349



UV/PZ/2FLG

V-730
BASIC SQUARE

▶ 350



UV/PZ/PRIVACY/2FLG

V-200 ECO
MV-200 ECO

▶ 351



UV/PZ/2FLG

V-720
MV-720
LIBRA

▶ 352-353



UV/PZ/WC/BB/2FLG

V-720 ECO
MV-720 ECO

▶ 354-355



V-400
MV-400
FERRARI

▶ 361



UV/PZ/WC/BB/PRIVACY/2FLG

V-100
MV-100
ONE

▶ 362



UV/PZ/BB/2FLG

SERRATURE VERTICALI PER PORTE BATTENTI
VERTICAL LOCKS FOR SWING DOORS
VERTIKALE SCHLÖSSER FÜR DREH-TÜREN

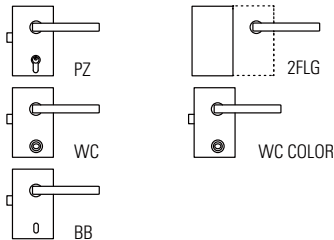

V-780
VERTICAL FLAT

▶ 356



V-780 WC COLOR
VERTICAL FLAT

▶ 357



V-780 WC
VERTICAL FLAT

▶ 356



V-750
MV-750
VERTICALE

▶ 358-359



PZ/WC/BB/2FLG/WC COLOR

V-770
SECUR

▶ 362



PZ/BB/WC/2FLG

SERRATURE PICCOLE PER PORTE BATTENTI
COMPACTED LOCKS FOR SWING DOORS
COMPAKTE SCHLÖSSER FÜR DREH-TÜREN

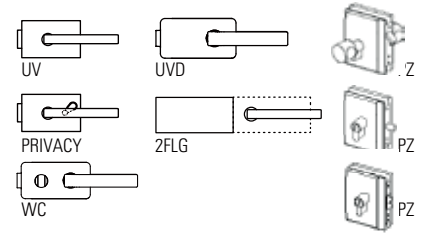

V-900
I-LOCK

▶ 346



PZ/UV/UVD/WC/2FLG

MV-900
I-LOCK

▶ 348



PZ/UVD/WC

V-540
MINIMA FLAT

▶ 349



UV/PRIVACY/2FLG

V-700
SQUARE

▶ 361



UV/PRIVACY

V-519 / V-520
MINIMA BATTUTA

▶ 371-372



PZ

SERRATURE PER PORTE SCORREVOLI
LOCKS FOR SLIDING DOORS
SCHLÖSSER FÜR SCHIEBETÜREN

SERRATURE PER PORTE SCORREVOLI E LIBERE
LOCKS FOR SLIDING DOORS AND FOR DOUBLE ACTION DOORS
SCHLÖSSER FÜR SCHIEBETÜREN UND FÜR GANZGLASANLAGEN

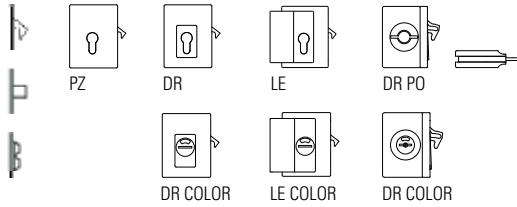

V-744 / V-744 COLOR
V-745 / V-745 COLOR
V-746 / V-746 COLOR
ELEGANT LEVER



PZ/2FLG/COLOR

▶ 365-366

V-734 / V-734 COLOR
V-735 / V-735 COLOR
V-736 / V-736 COLOR
ELEGANT DRAG



PZ/2FLG/COLOR

▶ 367-369

V-724 / V-725 / V-726
ELEGANT



PZ/2FLG

▶ 363

V-504 NC / V-505 / V-515
MINIMA



▶ 370

V-518
MINIMA BATTUTA



▶ 371

V-554 NC
V-557 BOTTE



▶ 372

V-529 / V-530
CONTROSERRATURA



▶ 373

V-564 / V-564 COLOR
V-565 / V-565 COLOR
MINIMA 55



▶ 374-375

V-584 / V-584 COLOR
V-585 / V-585 COLOR
MINIMA 55 LEVER



▶ 376-377

V-594 / V-594 COLOR
MINIMA DRAG



▶ 377-378

V-574 / V-575
MINIMA 55 RIBASSATA



▶ 379

V-785 / V-785 COLOR
V-775 / V-775 COLOR
EASY LOCK



▶ 380

V-404



▶ 380

WC/PO/2FLG/WC COLOR

V-604 / V-407

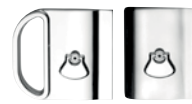

▶ 381-383

LE/PO/WC/CH/2FLG

X-133



▶ 448

PZ

X-030 C



▶ 442

PZ

ACCESSORI
ACCESSORIES
ZUBEHÖRE



CONTROPIASTRE
STRIKE PLATES
SCHLIEßBLECHE



▶ 384

CILINDRI
CYLINDERS
ZYLINDER



▶ 387

CRICCHETTI
ROLLER BOLTS
TÜRSCHNÄPPER



▶ 389

CATENACCIOLI
LOCKING BOLT
FESTSTELLER



▶ 389

X-317



▶ 448

ACCESSORI
PER VETRINE
ACCESSORIES
FOR DISPLAY CABINETS
ZUBEHÖRE
FÜR SCHAUFENSTERAUSLAGE

B-309



▶ 391

GUIDA TECNICA PER LA SCELTA DEL VOSTRO SISTEMA
TECHNICAL GUIDE FOR THE CHOICE OF YOUR SYSTEM
AUSWAHL VON SYSTEME NACH VORHANDENEN KRITERIEN

CERNIERE VERTICALI PER PORTE BATTENTI
VERTICAL HINGES
VERTIKALE BÄNDER

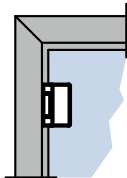

V-709 LIBRA

▶ 391



V-509 SLIM

▶ 391



V-809

▶ 391



V-701

▶ 392



V-909

▶ 392



V-729

▶ 393



V-409 STILO

▶ 393



V-719 LIBRA

▶ 393



P-08
CERNIERE TUTTA
ALTEZZA INCOLLAGGIO

▶ 394



P-09
CERNIERE
TUTTA ALTEZZA

▶ 394



CERNIERE ALTO/BASSO
TOP/BOTTOM
OBERE/UNTERE BÄNDER

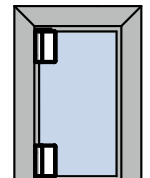

V-704 DX-SX

▶ 392



V-707 DX-SX

▶ 393



V-107
SLIM

▶ 393



CERNIERE VERTICALI PER STIPITI TEDESCHI
VERTICAL HINGES FOR GERMAN FRAMES
3-TEILIGE BÄNDER DIN ZARGEN

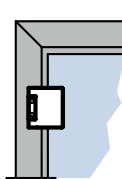

V-402

▶ 392



V-702
ZETA

▶ 393



CERNIERE ORIZZONTALI
HORIZONTAL HINGES
HORIZONTALE BÄNDER

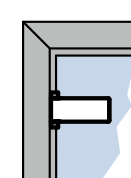

V-202

▶ 395



V-403

▶ 395



CERNIERE ORIZZONTALI PER STIPITI TEDESCHI
HORIZONTAL HINGES FOR GERMAN FRAMES
2-TEILIGE BÄNDER DIN ZARGEN

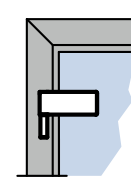

V-201

▶ 395



V-401
FERRARI

▶ 395



V-102
ONE

▶ 395



CERNIERE VETRO/VETRO
GLASS/GLASS HINGES
GLAS/GLAS BÄNDER

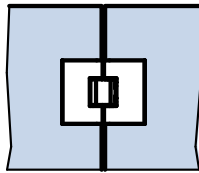

V-739
▶ 393



V-513 SLIM
▶ 393



L-220
▶ 172



CERNIERE OLEODINAMICHE
HYDRAULIC HINGES
HYDRAULISCHE BÄNDER

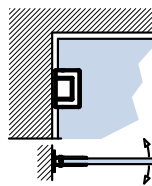

V-808
V-808-AS
▶ 397



V-816
▶ 397



V-808-R
▶ 397



V-816-R
▶ 397



V-807
▶ 397



CERNIERE INFERIORI OLEODINAMICHE
HYDRAULIC BOTTOM HINGES
HYDRAULISCHE UNTERE BÄNDER

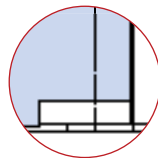

V-H1012 / V-H1013
"OLLY"
▶ 439



LAM-H1006
LAM-H1008
▶ 432



LAM-H1007
▶ 432



CERNIERE AUTOMATICHE
AUTOMATIC HINGES
AUTOMATISCHE BÄNDER

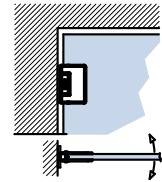

V-908
V-908 AS
▶ 396



V-508
V-508 AS
▶ 396



V-516
396



V-507
▶ 396



ANTIK
▶ 444









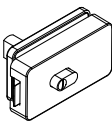
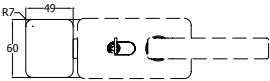

POS.	PROD.	ART.	Q.TÀ	FIN.	EURO	FIN.	EURO	FIN.	EURO
SERRATURE LOCKS / SCHLÖSSER									
<ul style="list-style-type: none"> • Maniglie, cilindri e contropiastre da ordinare a parte • Handles, cylinders and strike plates not included, to order separately • Griffe, Zylinder und Schließbleche nicht enthalten, separat zu bestellen 									
I-LOCK V-900 ▶ INDOOR 68									
E. 01		V-900 PZ	1 pc	CS	128,70 /pc	NS	130,70 /pc	CR	144,30 /pc
		V-900 PZ	1 pc	CP	128,70 /pc	NO	150,70 /pc	GR	122,00 /pc
		V-900 PZ	■ min 18 pcs	CS	98,00 /pc	NS	102,50 /pc	CR	114,00 /pc
				CP	98,00 /pc	NO	119,50 /pc	GR	90,00 /pc
E. 02		V-900 UV	1 pc	CS	144,30 /pc	NS	146,70 /pc	CR	169,00 /pc
		V-900 UV	1 pc	CP	144,30 /pc	NO	176,00 /pc		
		V-900 UV	■ min 18 pcs	CS	116,30 /pc	NS	118,50 /pc	CR	132,00 /pc
				CP	116,30 /pc	NO	138,30 /pc		
E. 03		V-900 UVD	1 pc	CS	128,70 /pc	NS	130,70 /pc	CR	144,30 /pc
		V-900 UVD	1 pc	CP	128,70 /pc	NO	150,70 /pc		
		V-900 UVD	■ min 18 pcs	CS	98,00 /pc	NS	102,50 /pc	CR	114,00 /pc
				CP	98,00 /pc	NO	119,50 /pc		
E. 04		V-900 WC	1 pc	CS	204,30 /pc	NS	207,30 /pc	CR	214,30 /pc
		V-900 WC	1 pc	CP	204,30 /pc	NO	226,50 /pc		
		V-900 WC	■ min 18 pcs	CS	168,30 /pc	NS	170,50 /pc	CR	184,30 /pc
				CP	168,30 /18 pc	NO	193,00 /18 pc		
E. 05		V-900 PRIVACY	1 pc	CS	256,00 /pc	NS	258,50 /pc	CR	265,70 /pc
		V-900 PRIVACY	1 pc	CP	256,00 /pc	NO	278,30 /pc		
		V-900 PRIVACY	■ min 18 pcs	CS	215,00 /pc	NS	212,00 /pc	CR	225,30 /pc
				CP	209,00 /pc	NO	234,00 /pc		

- Confezioni industriali
- Industrial packaging
- Industrieverpackungen

■ **min**

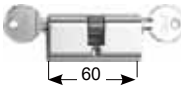
- Prezzi speciali per l'acquisto delle quantità minime indicate dell'articolo. NB eventuali riordini o aggiunte per completamenti se di quantità inferiore alla minima, saranno fatturati al prezzo normale
- Special prices for the purchase of the minimum quantities indicated of the article. Note Well: any reorders or additions for completions of quantity less than the minimum will be invoiced at the normal price.
- Artikel mit Sonderpreisen bei Mindestabnahmemengen sind mit gekennzeichnet. Nachbestellungen oder Ergänzungen unter der Mindestabnahmemenge werden mit dem Normalpreis verrechnet.

POS.	PROD.	ART.	Q.TÀ	FIN.	EURO	FIN.	EURO	FIN.	EURO
E. 06		V-900-ELET-PZ	1 pc	NS	266,30 /pc	CP	266,30 /pc		
E. 07		V-900 2FLG	1 pc	CS	91,50 /pc	NS	93,70 /pc	CR	106,50 /pc
		V-900 2FLG	■ min 18 pcs	CP	91,50 /pc	NO	118,50 /pc	GR	86,30 /pc
		V-900 2FLG	■ min 18 pcs	CS	64,70 /pc	NS	70,70 /pc	CR	84,30 /pc
		V-900 2FLG	■ min 18 pcs	CP	68,50 /pc	NO	92,70 /pc	GR	60,00 /pc
E. 08		C-020	1 pc	CR	28,00 /pc				
E. 09		C-021	1 pc	NS	57,00 /pc	CR	64,50 /pc	CP	62,00 /pc
E. 10		C-019	1 pc	NS	63,30 /pc	CR	70,70 /pc	CP	68,30 /pc
E. 11		CP-01	1 pc	AN	14,70 /pc				
		CP-01	■ min 10 pcs	AN	10,70 /pc				
E. 12		V-037	1 pc	IX	11,30 /pc				
		V-037	■ min 10 pcs	IX	6,30 /pc				
I-LOCK AN - IX									▶ INDOOR 70
E. 13		V-900 PZ	1 pc	AN	105,30 /pc				
		V-900 PZ	■ min 20 pcs	IX	107,50 /pc				
		V-900 PZ	■ min 20 pcs	AN	81,00 /pc				
		V-900 PZ	■ min 20 pcs	IX	84,30 /pc				
E. 14		C-025	1 pc	CR	28,00 /pc				
E. 15		C-021	1 pc	NS	57,00 /pc	CR	64,50 /pc	CP	62,00 /pc

POS.	PROD.	ART.	Q.TÀ	FIN.	EURO	FIN.	EURO	FIN.	EURO
E. 16		C-019	1 pc	NS	63,30 /pc	CR	70,70 /pc	CP	68,30 /pc
E. 17		V-931	1 pc	AN	37,00 /pc	NS	41,30 /pc		
		V-931	■ min 20 pcs	AN	26,50 /pc	NS	30,30 /pc		
E. 18		V-900 2FLG	1 pc	AN	74,30 /pc	IX	86,70 /pc		
		V-900 2FLG	■ min 10 pcs	AN	57,70 /pc	IX	70,00 /pc		
E. 19		KIT-V-900 PZ	1 pc	AN	166,50 /pc	IX	181,00 /pc		
		KIT-V-900 PZ	■ min 20 pcs	AN	148,00 /pc	IX	162,50 /pc		
<ul style="list-style-type: none"> • Kit completo con: serratura V-900 PZ, maniglia V-1731 Elektra-(AN-IXE), cilindro C-025 e contropiastra V-037 • Kit complete with: lock V-900 PZ, handle V-1731 Elektra-(AN-IXE), cylinder C-025 and strike plate V-037 • Kit Komplett mit: Schloss V-900 PZ, Griff V-1731 Elektra-(AN-IXE), Zylinder C-025 und Schließblech V-037 									
I-LOCK MV-900 MAGNETIC VERSION ▶ INDOOR 72									
E. 20		MV-900 PZ	1 pc	CS	215,00 /pc	NS	217,30 /pc	CR	227,00 /pc
				CP	215,00 /pc	NO	233,30 /pc		
		MV-900 PZ	■ min 18 pcs	CS	188,70 /pc	NS	191,30 /pc	CR	201,00 /pc
				CP	188,70 /18 pc	NO	209,00 /18 pc		
E. 21		MV-900 UVD	1 pc	CS	215,00 /pc	NS	217,30 /pc	CR	227,00 /pc
				CP	215,00 /pc	NO	233,30 /pc		
		MV-900 UVD	■ min 18 pcs	CS	188,70 /pc	NS	191,30 /pc	CR	201,00 /pc
				CP	188,70 /18 pc	NO	209,00 /18 pc		
E. 22		MV-900 WC	1 pc	CS	278,30 /pc	NS	280,70 /pc	CR	290,50 /pc
				CP	278,30 /pc	NO	298,50 /pc		
		MV-900 WC	■ min 18 pcs	CS	254,50 /pc	NS	257,00 /pc	CR	266,30 /pc
				CP	254,50 /pc	NO	274,70 /pc		
E. 23		C-022	1 pc	NS	155,00 /pc				
E. 24		CP-012							
<ul style="list-style-type: none"> • Contropiastra magnetica <u>inclusa</u> • Magnetic strike plate <u>included</u> • Magnetisches Schließblech <u>inkl.</u> 									







- Confezioni industriali
- Industrial packaging
- Industrieverpackungen

- **min**
- Prezzi speciali per l'acquisto delle quantità minime indicate dell'articolo. NB eventuali riordini o aggiunte per completamenti se di quantità inferiore alla minima, saranno fatturati al prezzo normale
- Special prices for the purchase of the minimum quantities indicated of the article. Note Well: any reorders or additions for completions of quantity less than the minimum will be invoiced at the normal price.
- Artikel mit Sonderpreisen bei Mindestabnahmemengen sind mit gekennzeichnet. Nachbestellungen oder Ergänzungen unter der Mindestabnahmemenge werden mit dem Normalpreis verrechnet.

MV

- Versione Magnetica compresa di contropiastra magnetica finitura:CS
- Magnetic version with magnetic strike plate included in finish CS
- Mit magnetischen Schließvorgang inkl. magnetische Schließblech CS

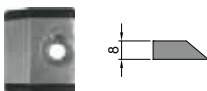

POS.	PROD.	ART.	Q.TÀ	FIN.	EURO	FIN.	EURO	FIN.	EURO
V-540 MINIMA FLAT ▶ INDOOR 74									
E. 25		V-540 UV	1 pc	CS	162,50 /pc	NS	165,50 /pc	CR	203,30 /pc
				CP	188,70 /pc				
	V-540 UV	■ min 20 pcs	CS	114,50 /pc	NS	117,70 /pc	CR	136,30 /pc	
			CP	126,30 /pc					
E. 26		V-540 Privacy	1 pc	CS	229,00 /pc	NS	232,50 /pc	CR	258,50 /pc
				CP	240,30 /pc				
	V-540 Privacy	■ min 20 pcs	CS	181,00 /pc	NS	184,50 /pc	CR	199,30 /pc	
			CP	192,30 /pc					
E. 27		V-540 2FLG	1 pc	CS	91,50 /pc	NS	93,70 /pc	CR	106,50 /pc
				CP	91,50 /pc				
	V-540 2FLG	■ min 10 pcs	CS	68,50 /pc	NS	70,70 /pc	CR	84,30 /pc	
			CP	68,50 /pc					
V-230 BASIC ROUND ▶ INDOOR 76									
E. 28		V-230 UV	1 pc	AN	103,00 /pc	NS	103,00 /pc		
		V-230 UV	■ min 10 pcs	AN	91,70 /pc	NS	91,70 /pc		
E. 29		V-230 PZ	1 pc	AN	108,00 /pc	NS	108,00 /pc		
		V-230 PZ	■ min 10 pcs	AN	97,00 /pc	NS	97,00 /pc		
<ul style="list-style-type: none"> • con vetro 8/10 mm cilindri adatti (pag. 387) • with glass 8/10 mm. suitable cylinders (page 387) • mit Glas 8/10 mm. Lieferbare Zylinder (Seite 387) <p style="text-align: right;">C-04 C-05 C-13</p>									
E. 30		V-230 2FLG	1 pc	AN	210,50 /pc				
				NS	210,50 /pc				
	V-230 2FLG	■ min 10 pcs	AN	187,30 /pc					
			NS	187,30 /pc					
E. 31		V-001 B	1 pc		13,30 /pc				
		V-001 B	■ min 10 pcs		8,30 /pc				

POS.	PROD.	ART.	Q.TÀ	FIN.	EURO	FIN.	EURO	FIN.	EURO
V-730 BASIC SQUARE ▶ INDOOR 78									
E. 32		V-730 UV	1 pc	AN	104,00 /pc	NS	104,00 /pc		
		V-730 UV	■ min 10 pcs	AN	93,00 /pc	NS	93,00 /pc		
E. 33		V-730 PZ	1 pc	AN	111,30 /pc	NS	111,30 /pc		
		V-730 PZ	■ min 10 pcs	AN	99,70 /pc	NS	99,70 /pc		
				<ul style="list-style-type: none"> • con vetro 8/10 mm cilindri adatti (pag. 387) • with glass 8/10 mm. suitable cylinders (page 387) • mit Glas 8/10 mm. Lieferbare Zylinder (Seite 387) 					
E. 34		V-730 2FLG	1 pc	AN	215,00 /pc	NS	215,00 /pc		
		V-730 2FLG	■ min 10 pcs	AN	191,30 /pc	NS	191,30 /pc		
E. 35		V-001 B	1 pc		13,30 /pc				
		V-001 B	■ min 10 pcs		8,30 /pc				
V-200 ECO ▶ INDOOR 80									
E. 36		V-200 ECO	1 pc	IX	124,50 /pc	AN	149,00 /pc	CS	182,00 /pc
				NS	183,30 /pc	CR	198,30 /pc	OL	198,30 /pc
				CP	183,30 /pc				
		V-200 ECO	■ min 10 pcs	IX	108,00 /pc	AN	136,00 /pc	CS	171,00 /pc
				NS	172,30 /pc	CR	187,70 /pc	OL	187,70 /pc
				CP	172,30 /pc				
E. 37	 V-200 ECO PZ V-200 ECO BB	V-200 ECO PZ V-200 ECO BB	1 pc	IX	126,30 /pc	AN	151,00 /pc	CS	183,50 /pc
				NS	184,50 /pc	CR	200,30 /pc	OL	200,30 /pc
				CP	184,50 /pc				
		V-200 ECO PZ V-200 ECO BB	■ min 10 pcs	IX	109,50 /pc	AN	137,30 /pc	CS	173,00 /pc
				NS	174,30 /pc	CR	189,30 /pc	OL	189,30 /pc
				CP	174,30 /pc				
				<ul style="list-style-type: none"> • con vetro 8/10 mm cilindri adatti (pag. 387) • with glass 8/10 mm. suitable cylinders (page 387) • mit Glas 8/10 mm. Lieferbare Zylinder (Seite 387) 					

- Confezioni industriali
- Industrial packaging
- Industrieverpackungen



■ min

- Prezzi speciali per l'acquisto delle quantità minime indicate dell'articolo. NB eventuali riordini o aggiunte per completamenti se di quantità inferiore alla minima, saranno fatturati al prezzo normale
- Special prices for the purchase of the minimum quantities indicated of the article. Note Well: any reorders or additions for completions of quantity less than the minimum will be invoiced at the normal price.
- Artikel mit Sonderpreisen bei Mindestabnahmemengen sind mit gekennzeichnet. Nachbestellungen oder Ergänzungen unter der Mindestabnahmemenge werden mit dem Normalpreis verrechnet.

■ MV

- Versione Magnetica compresa di contropiastra magnetica finitura:CS
- Magnetic version with magnetic strike plate included in finish CS
- Mit magnetischen Schließvorgang inkl. magnetische Schließblech CS

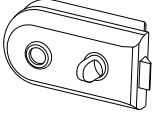
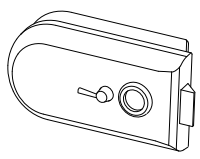
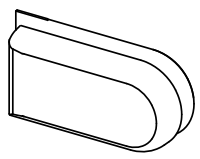

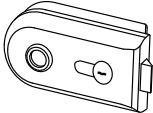
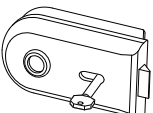
POS.	PROD.	ART.	Q.TÀ	FIN.	EURO	FIN.	EURO	FIN.	EURO
E. 38		V-200 ECO WC	1 pc	IX	178,00 /pc	AN	202,50 /pc	CS	235,50 /pc
				NS	236,50 /pc	CR	252,00 /pc	OL	252,00 /pc
				CP	236,50 /pc				
		V-200 ECO WC	■ min 10 pcs	IX	161,50 /pc	AN	189,30 /pc	CS	225,00 /pc
				NS	226,00 /pc	CR	241,50 /pc	OL	241,50 /pc
				CP	226,00 /pc				
E. 39		V-200 ECO P	1 pc	IX	225,00 /pc	AN	249,30 /pc	CS	281,70 /pc
				NS	282,70 /pc	CR	298,50 /pc	OL	298,50 /pc
				CP	282,70 /pc				
		V-200 ECO P	■ min 10 pcs	IX	198,30 /pc	AN	226,50 /pc	CS	262,00 /pc
				NS	263,00 /pc	CR	278,30 /pc	OL	278,30 /pc
				CP	263,00 /pc				
E. 40		V-200 ECO 2FLG	1 pc	IX	186,30 /pc	AN	201,00 /pc	CS	271,30 /pc
				NS	273,50 /pc	CR	296,30 /pc	OL	296,30 /pc
				CP	271,30 /pc				
		V-200 ECO 2FLG	■ min 10 pcs	IX	161,50 /pc	AN	183,30 /pc	CS	257,00 /pc
				NS	259,00 /pc	CR	280,70 /pc	OL	280,70 /pc
				CP	257,00 /pc				
MV-200 ECO  MAGNETIC VERSION									► INDOOR 80
E. 41		MV-200 ECO	1 pc	IX	186,30 /pc	AN	211,00 /pc	CS	243,50 /pc
				NS	244,70 /pc	CR	260,50 /pc	OL	260,50 /pc
				CP	244,70 /pc				
		MV-200 ECO	■ min 10 pcs	IX	169,70 /pc	AN	197,70 /pc	CS	233,30 /pc
				NS	234,30 /pc	CR	250,00 /pc	OL	250,00 /pc
				CP	234,30 /pc				
E. 42		MV-200 ECO PZ MV-200 ECO BB	1 pc	IX	188,30 /pc	AN	213,00 /pc	CS	245,70 /pc
				NS	246,70 /pc	CR	262,30 /pc	OL	262,30 /pc
				CP	246,70 /pc				
		MV-200 ECO PZ MV-200 ECO BB	■ min 10 pcs	IX	171,50 /pc	AN	199,30 /pc	CS	234,70 /pc
				NS	235,70 /pc	CR	251,30 /pc	OL	251,30 /pc
				CP	235,70 /pc				

POS.	PROD.	ART.	Q.TÀ	FIN.	EURO	FIN.	EURO	FIN.	EURO
E. 43		MV-200 ECO WC	1 pc	IX	240,30 /pc	AN	264,50 /pc	CS	297,50 /pc
				NS	298,50 /pc	CR	314,30 /pc	OL	314,30 /pc
				CP	298,50 /pc				
		MV-200 ECO WC	■ min 10 pcs	IX	223,50 /pc	AN	251,30 /pc	CS	286,70 /pc
				NS	287,70 /pc	CR	303,30 /pc	OL	303,30 /pc
				CP	287,70 /pc				
E. 44		MV-200 ECO P	1 pc	IX	286,70 /pc	AN	311,00 /pc	CS	344,00 /pc
				NS	345,30 /pc	CR	361,00 /pc	OL	361,00 /pc
				CP	345,30 /pc				
		MV-200 ECO P	■ min 10 pcs	IX	260,50 /pc	AN	288,50 /pc	CS	323,70 /pc
				NS	324,70 /pc	CR	340,30 /pc	OL	340,30 /pc
				CP	324,70 /pc				
E. 45		MV-200 ECO 2FLG	1 pc	IX	260,50 /pc	AN	274,70 /pc	CS	345,30 /pc
				NS	347,50 /pc	CR	370,00 /pc	OL	370,00 /pc
				CP	345,30 /pc				
		MV-200 ECO 2FLG	■ min 10 pcs	IX	235,50 /pc	AN	257,00 /pc	CS	331,00 /pc
				NS	333,30 /pc	CR	354,50 /pc	OL	354,50 /pc
				CP	331,00 /pc				
V-720 LIBRA ▶ INDOOR 82									
E. 46		V-720 UV	1 pc	CS	187,70 /pc	NS	188,70 /pc	CR	211,50 /pc
				OL	211,50 /pc	CP	188,70 /pc	NO	211,50 /pc
		V-720 UV	■ min 10 pcs	CS	176,70 /pc	NS	178,00 /pc	CR	199,30 /pc
				OL	199,30 /pc	CP	178,00 /pc	NO	199,30 /pc

- Confezioni industriali
- Industrial packaging
- Industrieverpackungen











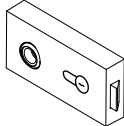
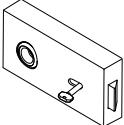

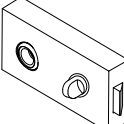
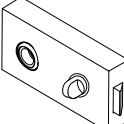
■ min

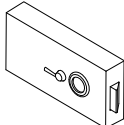
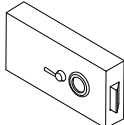
- Prezzi speciali per l'acquisto delle quantità minime indicate dell'articolo. NB eventuali riordini o aggiunte per completamenti se di quantità inferiore alla minima, saranno fatturati al prezzo normale
- Special prices for the purchase of the minimum quantities indicated of the article. Note Well: any reorders or additions for completions of quantity less than the minimum will be invoiced at the normal price.
- Artikel mit Sonderpreisen bei Mindestabnahmemengen sind mit gekennzeichnet. Nachbestellungen oder Ergänzungen unter der Mindestabnahmemenge werden mit dem Normalpreis verrechnet.

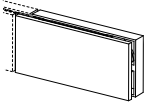
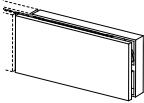
■ MV

- Versione Magnetica compresa di contropiastra magnetica finitura:CS
- Magnetic version with magnetic strike plate included in finish CS
- Mit magnetischen Schließvorgang inkl. magnetische Schließblech CS



POS.	PROD.	ART.	Q.TÀ	FIN.	EURO	FIN.	EURO	FIN.	EURO
E. 47	 V-720 PZ	V-720 PZ V-720 BB	1 pc	CS	189,30 /pc	NS	190,50 /pc	CR	213,30 /pc
				OL	213,30 /pc	CP	190,50 /pc	NO	213,30 /pc
	 V-720 BB	V-720 PZ V-720 BB	 min 10 pcs	CS	178,70 /pc	NS	180,00 /pc	CR	201,50 /pc
				OL	201,50 /pc	CP	180,00 /pc	NO	201,50 /pc
				<ul style="list-style-type: none"> • con vetro 8/10 mm cilindri adatti (pag. 387) • with glass 8/10 mm. suitable cylinders (page 387) • mit Glas 8/10 mm. Lieferbare Zylinder (Seite 387) 		C-01 C-02 C-03 C-04			
E. 48	 V-720 WC	V-720 WC	1 pc	CS	241,50 /pc	NS	242,50 /pc	CR	265,00 /pc
				OL	265,00 /pc	CP	242,50 /pc	NO	265,00 /pc
	 V-720 WC	V-720 WC	 min 10 pcs	CS	231,00 /pc	NS	232,30 /pc	CR	253,30 /pc
				OL	253,30 /pc	CP	232,30 /pc	NO	253,30 /pc
E. 49	 V-720 P	V-720 P	1 pc	CS	287,70 /pc	NS	288,70 /pc	CR	311,50 /pc
				OL	311,50 /pc	CP	288,70 /pc	NO	311,50 /pc
	 V-720 P	V-720 P	 min 10 pcs	CS	267,30 /pc	NS	269,00 /pc	CR	290,50 /pc
				OL	290,50 /pc	CP	269,00 /pc	NO	290,50 /pc
E. 50	 V-720 2FLG	V-720 2FLG	1 pc	CS	270,00 /pc	NS	272,50 /pc	CR	303,30 /pc
				OL	303,30 /pc	CP	270,00 /pc	NO	303,30 /pc
	 V-720 2FLG	V-720 2FLG	 min 10 pcs	CS	254,50 /pc	NS	257,00 /pc	CR	287,70 /pc
				OL	287,70 /pc	CP	254,50 /pc	NO	287,70 /pc
MV-720 LIBRA  MAGNETIC VERSION ▶ INDOOR 82									
E. 51	 MV-720 UV	MV-720 UV	1 pc	CS	250,00 /pc	NS	251,00 /pc	CR	273,50 /pc
				OL	273,50 /pc	CP	251,00 /pc	NO	273,50 /pc
	 MV-720 UV	MV-720 UV	 min 10 pcs	CS	239,00 /pc	NS	240,30 /pc	CR	262,00 /pc
				OL	262,00 /pc	CP	240,30 /pc	NO	262,00 /pc

POS.	PROD.	ART.	Q.TÀ	FIN.	EURO	FIN.	EURO	FIN.	EURO
E. 52	 MV-720 PZ MV-720 BB	MV-720 PZ MV-720 BB	1 pc	CS	251,30 /pc	NS	252,70 /pc	CR	275,30 /pc
				OL	275,30 /pc	CP	252,70 /pc	NO	275,30 /pc
		MV-720 PZ MV-720 BB	■ min 10 pcs	CS	240,70 /pc	NS	242,00 /pc	CR	263,50 /pc
				OL	263,50 /pc	CP	242,00 /pc	NO	263,50 /pc
				<ul style="list-style-type: none"> • con vetro 8/10 mm cilindri adatti (pag. 387) • with glass 8/10 mm. suitable cylinders (page 387) • mit Glas 8/10 mm. Lieferbare Zylinder (Seite 387) 		C-01 C-02 C-03 C-04			
E. 53	 MV-720 WC	MV-720 WC	1 pc	CS	303,30 /pc	NS	304,30 /pc	CR	327,30 /pc
				OL	327,30 /pc	CP	304,30 /pc	NO	327,30 /pc
		MV-720 WC	■ min 10 pcs	CS	292,70 /pc	NS	293,70 /pc	CR	315,30 /pc
				OL	315,30 /pc	CP	293,70 /pc	NO	315,30 /pc
E. 54	 MV-720 P	MV-720 P	1 pc	CS	350,30 /pc	NS	351,30 /pc	CR	373,50 /pc
				OL	373,50 /pc	CP	351,30 /pc	NO	373,50 /pc
		MV-720 P	■ min 10 pcs	CS	329,70 /pc	NS	331,00 /pc	CR	352,30 /pc
				OL	352,30 /pc	CP	331,00 /pc	NO	352,30 /pc
E. 55	 MV-720 2FLG	MV-720 2FLG	1 pc	CS	344,00 /pc	NS	346,30 /pc	CR	377,30 /pc
				OL	377,30 /pc	CP	344,00 /pc	NO	377,30 /pc
		MV-720 2FLG	■ min 10 pcs	CS	328,30 /pc	NS	331,00 /pc	CR	362,00 /pc
				OL	362,00 /pc	CP	328,30 /pc	NO	362,00 /pc
V-720 ECO									▶ INDOOR
E. 56	 V-720 ECO UV	V-720 ECO UV	1 pc	CS	132,00 /pc	NS	132,00 /pc	CP	132,00 /pc
		V-720 ECO UV	■ min 10 pcs	CS	115,70 /pc	NS	115,70 /pc	CP	115,70 /pc
E. 57	 V-720 PZ	V-720 ECO PZ	1 pc	CS	133,70 /pc	NS	133,70 /pc	CP	133,70 /pc
		V-720 ECO PZ	■ min 10 pcs	IX	117,50 /pc	AN	117,50 /pc	CP	117,50 /pc
				<ul style="list-style-type: none"> • con vetro 8/10 mm cilindri adatti (pag. 387) • with glass 8/10 mm. suitable cylinders (page 387) • mit Glas 8/10 mm. Lieferbare Zylinder (Seite 387) 		C-01 C-02 C-03 C-04			



- Confezioni industriali
- Industrial packaging
- Industrieverpackungen

- **min**
- Prezzi speciali per l'acquisto delle quantità minime indicate dell'articolo. NB eventuali riordini o aggiunte per completamenti se di quantità inferiore alla minima, saranno fatturati al prezzo normale
- Special prices for the purchase of the minimum quantities indicated of the article. Note Well: any reorders or additions for completions of quantity less than the minimum will be invoiced at the normal price.
- Artikel mit Sonderpreisen bei Mindestabnahmemengen sind mit gekennzeichnet. Nachbestellungen oder Ergänzungen unter der Mindestabnahmemenge werden mit dem Normalpreis verrechnet.

MV

- Versione Magnetica compresa di contropiastra magnetica finitura:CS
- Magnetic version with magnetic strike plate included in finish CS
- Mit magnetischen Schließvorgang inkl. magnetische Schließblech CS

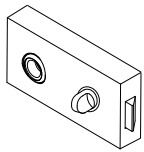
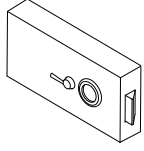
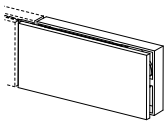

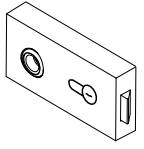
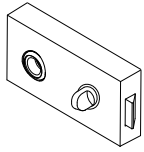
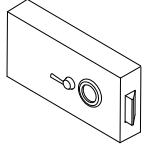
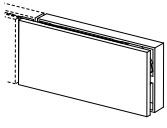



POS.	PROD.	ART.	Q.TÀ	FIN.	EURO	FIN.	EURO	FIN.	EURO
E. 58		V-720 ECO WC	1 pc	CS	186,30 /pc	NS	186,30 /pc	CP	186,30 /pc
		V-720 ECO WC	■ min 10 pcs	CS	169,30 /pc	NS	169,30 /pc	CP	169,30 /pc
E. 59		V-720 ECO P	1 pc	CS	232,30 /pc	NS	232,30 /pc	CP	232,30 /pc
		V-720 ECO P	■ min 10 pcs	CS	206,00 /pc	NS	206,00 /pc	CP	206,00 /pc
E. 60		V-720 ECO 2FLG	1 pc	NS	222,30 /pc				
		V-720 ECO 2FLG	■ min 10 pcs	NS	210,50 /pc				
MV-720 ECO  MAGNETIC VERSION									▶ INDOOR 82
E. 61		MV-720 UV ECO	1 pc	CS	194,30 /pc	NS	194,30 /pc	CP	194,30 /pc
		MV-720 UV ECO	■ min 10 pcs	CS	177,50 /pc	NS	177,50 /pc	CP	177,50 /pc
E. 62	MV-720 PZ 	MV-720 ECO PZ	1 pc	CS	196,30 /pc	NS	196,30 /pc	CP	196,30 /pc
		MV-720 ECO PZ	■ min 10 pcs	CS	179,30 /pc	NS	179,30 /pc	CP	179,30 /pc
				<ul style="list-style-type: none"> • con vetro 8/10 mm cilindri adatti (pag. 387) • with glass 8/10 mm. suitable cylinders (page 387) • mit Glas 8/10 mm. Lieferbare Zylinder (Seite 387) 		C-01 C-02 C-03 C-04			
E. 63		MV-720 ECO WC	1 pc	CS	194,30 /pc	NS	194,30 /pc	CP	194,30 /pc
		MV-720 ECO WC	■ min 10 pcs	CS	177,50 /pc	NS	177,50 /pc	CP	177,50 /pc
E. 64		MV-720 ECO P	1 pc	CS	294,50 /pc	NS	294,50 /pc	CP	294,50 /pc
		MV-720 ECO P	■ min 10 pcs	CS	268,30 /pc	NS	268,30 /pc	CP	268,30 /pc
E. 65		MV-720 ECO 2FLG	1 pc	NS	296,30 /pc				
		MV-720 ECO 2FLG	■ min 10 pcs	NS	284,50 /pc				







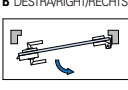
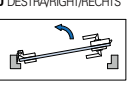
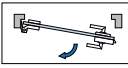
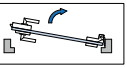

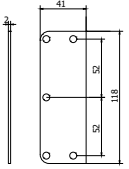
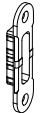

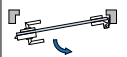
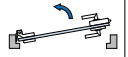

POS.	PROD.	ART.	Q.TÀ	FIN.	EURO	FIN.	EURO	FIN.	EURO			
V-780 VERTICALE ▶ INDOOR 84-89												
E. 66	<p>V-780 PZ-L V-780 PZ-R</p> <p>V-780 PZ-R PZ DX</p> <p>B DESTRA/RIGHT/RECHTS D DESTRA/RIGHT/RECHTS</p> <p>V-780 PZ-L PZ SX</p> <p>A SINISTRA/LEFT/LINKS C SINISTRA/LEFT/LINKS</p>	<p>V-780 PZ-L V-780 PZ-R</p>	1 pc	CS	221,70 /pc	NS	246,30 /pc	CP	239,00 /pc			
			GR	191,00 /pc								
			CS	168,00 /pc	NS	187,30 /pc	CP	178,70 /pc				
			GR	138,30 /pc								
			■ min 10 pcs	<ul style="list-style-type: none"> • SPECIFICARE SE PER APERTURA DESTRA O SINISTRA • PLEASE SPECIFY ALWAYS OPENING DIRECTION • BITTE IMMER ÖFFNUNGSRICHTUNG ANGEBEN 								
E. 67		C-020	1 pc	CR	28,00 /pc							
E. 68		C-021	1 pc	NS	57,00 /pc	CR	64,50 /pc	CP	62,00 /pc			
E. 69		C-019	1 pc	NS	63,30 /pc	CR	70,70 /pc	CP	68,30 /pc			
E. 70	<p>V-780 WC-L V-780 WC-R</p> <p>V-780 WC-R</p> <p>B DESTRA/RIGHT/RECHTS D DESTRA/RIGHT/RECHTS</p> <p>V-780 WC-L</p> <p>A SINISTRA/LEFT/LINKS C SINISTRA/LEFT/LINKS</p>	<p>V-780 WC-L V-780 WC-R</p>	1 pc	CS	305,00 /pc	NS	332,30 /pc	CP	317,30 /pc			
			CS	250,00 /pc	NS	262,30 /pc	CP	257,30 /pc				
						■ min 10 pcs	<ul style="list-style-type: none"> • SPECIFICARE SE PER APERTURA DESTRA O SINISTRA • PLEASE SPECIFY ALWAYS OPENING DIRECTION • BITTE IMMER ÖFFNUNGSRICHTUNG ANGEBEN 					

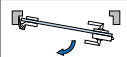
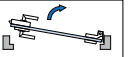
- Confezioni industriali
- Industrial packaging
- Industrieverpackungen

■ min

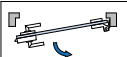
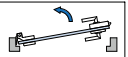
- Prezzi speciali per l'acquisto delle quantità minime indicate dell'articolo. NB eventuali riordini o aggiunte per completamenti se di quantità inferiore alla minima, saranno fatturati al prezzo normale
- Special prices for the purchase of the minimum quantities indicated of the article. Note Well: any reorders or additions for completions of quantity less than the minimum will be invoiced at the normal price.
- Artikel mit Sonderpreisen bei Mindestabnahmemengen sind mit gekennzeichnet. Nachbestellungen oder Ergänzungen unter der Mindestabnahmemenge werden mit dem Normalpreis verrechnet.

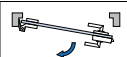
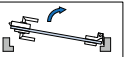
POS.	PROD.	ART.	Q.TÀ	FIN.	EURO	FIN.	EURO	FIN.	EURO
E. 71	  V-780 WC COLOR-R WC DX B DESTRA/RIGHT/RECHTS D DESTRA/RIGHT/RECHTS   V-780 WC COLOR-L WC SX A SINISTRA/LEFT/LINKS C SINISTRA/LEFT/LINKS  	V-780 WC-COLOR-L V-780 WC-COLOR-R	1 pc	CS	309,00 /pc	NS	329,00 /pc	CP	313,50 /pc
		V-780 WC-COLOR-L V-780 WC-COLOR-R	■ min 10 pcs	CS	232,50 /pc	NS	250,00 /pc	CP	243,50 /pc
				<ul style="list-style-type: none"> • SPECIFICARE SE PER APERTURA DESTRA O SINISTRA • PLEASE SPECIFY ALWAYS OPENING DIRECTION • BITTE IMMER ÖFFNUNGSRICHTUNG ANGEBEN 					
E. 72		V-780 2FLG	1 pc	CS	154,30 /pc	NS	157,70 /pc	CP	98,30 /pc
		V-780 2FLG	■ min 10 pcs	GR	86,70 /pc				
		V-780 2FLG	■ min 10 pcs	CS	122,00 /pc	NS	126,00 /pc	CP	80,30 /pc
		V-780 2FLG	■ min 10 pcs	GR	73,30 /pc				
E. 73		V-786	1 pc		27,70 /pc				
				<ul style="list-style-type: none"> • N. 1 spessore per vetro 12mm per serrature V-780. • 1 Stk.Distanzscheibe Glasdicke12 mm für Schlösser V-780 • N. 1 pc spacer for glass thickness 12 mm for locks V-780 					
E. 74		CP-01	1 pc	AN	14,70 /pc				
		CP-01	■ min 10 pcs	AN	10,70 /pc				

POS.	PROD.	ART.	Q.TÀ	FIN.	EURO	FIN.	EURO	FIN.	EURO
V-750 VERTICALE ▶ INDOOR 90									
E. 75	 V-750 PZ-R  B DESTRA/RIGHT/RECHTS D DESTRA/RIGHT/RECHTS   V-750 PZ-L  A SINISTRA/LEFT/LINKS C SINISTRA/LEFT/LINKS  	V-750 PZ-L V-750 PZ-R 1 pc	1 pc	CS	247,30 /pc	NS	257,00 /pc	CR	272,50 /pc
				OL	272,50 /pc	CP	247,30 /pc		
				C-05 C-06	<ul style="list-style-type: none"> • con vetro 8/10 mm cilindri adatti (pag. 387) • with glass 8/10 mm. suitable cylinders (page 387) • mit Glas 8/10 mm. Lieferbare Zylinder (Seite 387) 		<ul style="list-style-type: none"> • SPECIFICARE SE PER APERTURA DESTRA O SINISTRA • PLEASE SPECIFY ALWAYS OPENING DIRECTION • BITTE IMMER ÖFFNUNGSRICHTUNG ANGEBEN 		
E. 76	 V-750 BB-R  B DESTRA/RIGHT/RECHTS D DESTRA/RIGHT/RECHTS   V-750 BB-L  A SINISTRA/LEFT/LINKS C SINISTRA/LEFT/LINKS  	V-750 BB-L V-750 BB-R 1 pc	1 pc	CS	247,30 /pc	NS	257,00 /pc	CR	272,50 /pc
				OL	272,50 /pc	CP	247,30 /pc		
					<ul style="list-style-type: none"> • SPECIFICARE SE PER APERTURA DESTRA O SINISTRA • PLEASE SPECIFY ALWAYS OPENING DIRECTION • BITTE IMMER ÖFFNUNGSRICHTUNG ANGEBEN 				
E. 77	 V-750 WC	1 pc	1 pc	CS	272,50 /pc	NS	282,50 /pc	CR	296,50 /pc
					OL	296,50 /pc	CP	272,50 /pc	

- Confezioni industriali
- Industrial packaging
- Industrieverpackungen

min







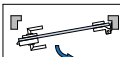
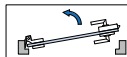

- Prezzi speciali per l'acquisto delle quantità minime indicate dell'articolo. NB eventuali riordini o aggiunte per completamenti se di quantità inferiore alla minima, saranno fatturati al prezzo normale
- Special prices for the purchase of the minimum quantities indicated of the article. Note Well: any reorders or additions for completions of quantity less than the minimum will be invoiced at the normal price.
- Artikel mit Sonderpreisen bei Mindestabnahmemengen sind mit gekennzeichnet. Nachbestellungen oder Ergänzungen unter der Mindestabnahmemenge werden mit dem Normalpreis verrechnet.

MV

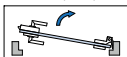
- Versione Magnetica compresa di contropiastra magnetica finitura:CS
- Magnetic version with magnetic strike plate included in finish CS
- Mit magnetischen Schließvorgang inkl. magnetische Schließblech CS



POS.	PROD.	ART.	Q.TÀ	FIN.	EURO	FIN.	EURO	FIN.	EURO
E. 78		V-750 WC COLOR	1 pc	CS	327,30 /pc	NS	327,30 /pc	CR	340,70 /pc
				CP	327,30 /pc				
E. 79		V-750 2FLG	1 pc	CS	347,00 /pc	NS	356,00 /pc	CR	370,50 /pc
				OL	370,50 /pc	CP	347,00 /pc		
E. 80		V-750-ELET-PZ-L V-750-ELET-PZ-R	1 pc	CP	373,30 /pc	NS	373,30 /pc		
<ul style="list-style-type: none"> SPECIFICARE SE PER APERTURA DESTRA O SINISTRA PLEASE SPECIFY ALWAYS OPENING DIRECTION BITTE IMMER ÖFFNUNGSRICHTUNG ANGEBEN 									
E. 81		CP-01	1 pc	AN	14,70 /pc				
		CP-01	■ min 10 pcs	AN	10,70 /pc				
MV-750 VERTICALE MAGNETIC VERSION ▶ INDOOR 90									
E. 82	 V-750 PZ-R B DESTRA/RIGHT/RECHTS D DESTRA/RIGHT/RECHTS V-750 PZ-L A SINISTRA/LEFT/LINKS C SINISTRA/LEFT/LINKS 	MV-750 PZ-L MV-750 PZ-R	1 pc	CS	307,50 /pc	NS	317,30 /pc	CR	332,30 /pc
				OL	332,30 /pc	CP	307,50 /pc		
<ul style="list-style-type: none"> con vetro 8/10 mm cilindri adatti (pag. 387) with glass 8/10 mm. suitable cylinders (page 387) mit Glas 8/10 mm. Lieferbare Zylinder (Seite 387) C-05 C-06 <ul style="list-style-type: none"> SPECIFICARE SE PER APERTURA DESTRA O SINISTRA PLEASE SPECIFY ALWAYS OPENING DIRECTION BITTE IMMER ÖFFNUNGSRICHTUNG ANGEBEN 									

POS.	PROD.	ART.	Q.TÀ	FIN.	EURO	FIN.	EURO	FIN.	EURO
E. 83	 V-750 BB-R B DESTRA/RIGHT/RECHTS D DESTRA/RIGHT/RECHTS    V-750 BB-L A SINISTRA/LEFT/LINKS C SINISTRA/LEFT/LINKS  	MV-750 BB-L MV-750 BB-R	1 pc	CS	307,50 /pc	NS	317,30 /pc	CR	332,30 /pc
				OL	332,30 /pc	CP	307,50 /pc		
E. 84		MV-750 WC	1 pc	CS	333,30 /pc	NS	343,50 /pc	CR	357,30 /pc
				OL	357,30 /pc	CP	333,30 /pc		
E. 85		MV-750 WC COLOR	1 pc	CS	381,00 /pc	NS	381,00 /pc	CR	394,70 /pc
				CP	381,00 /pc				
E.85.1		MV-750 2FLG	1 pc	CS	397,50 /pc	NS	407,00 /pc	CR	421,70 /pc
				OL	421,70 /pc	CP	397,50 /pc		
E. 86	 STANDARD INCLUDED	CP-012	1 pc	CP	34,30 /pc				
E. 87	 OPTIONAL	CP-013	1 pc	CP	44,30 /pc				
E. 87.1		V-756 <ul style="list-style-type: none"> • Kit fissaggio mezza maniglia fissa con serratura V-750 • Installation kit fixed half handle with lock V-750 • Befestigungsset fester Halbgriff mit Schloss V-750 	1 set		67,00 /set				

• SPECIFICARE SE PER APERTURA DESTRA O SINISTRA
 • PLEASE SPECIFY ALWAYS OPENING DIRECTION
 • BITTE IMMER ÖFFNUNGSRICHTUNG ANGEBEN



- Confezioni industriali
- Industrial packaging
- Industrieverpackungen











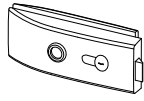
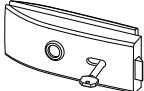

min

- Prezzi speciali per l'acquisto delle quantità minime indicate dell'articolo. NB eventuali riordini o aggiunte per completamenti se di quantità inferiore alla minima, saranno fatturati al prezzo normale
- Special prices for the purchase of the minimum quantities indicated of the article. Note Well: any reorders or additions for completions of quantity less than the minimum will be invoiced at the normal price.
- Artikel mit Sonderpreisen bei Mindestabnahmemengen sind mit gekennzeichnet. Nachbestellungen oder Ergänzungen unter der Mindestabnahmemenge werden mit dem Normalpreis verrechnet.

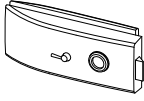
MV

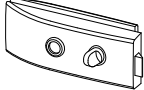
- Versione Magnetica compresa di contropiastra magnetica finitura:CS
- Magnetic version with magnetic strike plate included in finish CS
- Mit magnetischen Schließvorgang inkl. magnetische Schließblech CS

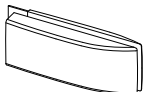

POS.	PROD.	ART.	Q.TÀ	FIN.	EURO	FIN.	EURO	FIN.	EURO	
V-700 SQUARE		DISPONIBILE FINO AD ESAURIMENTO SCORTE AVAILABLE WHILE STOCKS LAST LIEFERBAR SOLANGE DER VORRAT REICHT						▶ INDOOR 116		
E. 88		V-700 SQUARE	1 pc	CS	190,00 /pc	NS	198,00 /pc	CR	220,00 /pc	
				OL	220,00 /pc	CP	184,50 /pc			
E. 89		V-700 P	1 pc	CS	266,50 /pc	NS	274,30 /pc	CR	295,50 /pc	
				OL	295,50 /pc	CP	258,70 /pc			
E. 90		V-700 2FLG	1 pc	CS	268,50 /pc	NS	278,30 /pc	CR	307,50 /pc	
				OL	307,50 /pc	CP	262,00 /pc			
V-400 FERRARI								▶ INDOOR 116		
E. 91		V-400 FERRARI	1 pc	CS	226,30 /pc	NS	227,30 /pc	CR	249,30 /pc	
				OL	249,30 /pc	CP	225,30 /pc			
		V-400	■ min 10 pcs	CS	198,70 /pc	NS	199,70 /pc	CR	219,50 /pc	
				OL	219,50 /pc	CP	197,50 /pc			
MV-400 		CS	285,70 /pc	NS	287,00 /pc	CR	309,00 /pc			
	OL	309,00 /pc	CP	284,50 /pc						
E. 92	 	V-400 PZ V-400 BB	1 pc	CS	228,00 /pc	NS	229,00 /pc	CR	251,00 /pc	
				OL	251,00 /pc	CP	226,70 /pc			
		V-400-PZ V-400-BB	■ min 10 pcs	CS	200,50 /pc	NS	202,00 /pc	CR	221,00 /pc	
				OL	221,00 /pc	CP	199,30 /pc			
		MV-400 PZ 		CS	287,00 /pc	NS	288,70 /pc	CR	310,30 /pc	
			OL	310,30 /pc	CP	286,30 /pc				
				<ul style="list-style-type: none"> • con vetro 8/10 mm cilindri adatti (pag. 387) • with glass 8/10 mm. suitable cylinders (page 387) • mit Glas 8/10 mm. Lieferbare Zylinder (Seite 387) 						
E. 93		V-400-P	1 pc	CS	278,00 /pc	NS	279,00 /pc	CR	300,70 /pc	
				OL	300,70 /pc	CP	276,70 /pc			
		V-400-P	■ min 10 pcs	CS	250,30 /pc	NS	251,30 /pc	CR	271,00 /pc	
				OL	271,00 /pc	CP	249,30 /pc			
MV-400-P 		CS	337,50 /pc	NS	338,50 /pc	CR	360,30 /pc			
	OL	360,30 /pc	CP	336,50 /pc						
E. 94		V-400 WC	1 pc	CS	278,00 /pc	NS	279,00 /pc	CR	300,70 /pc	
				OL	300,70 /pc	CP	276,70 /pc			
		MV-400-WC 	1 pc	CS	337,50 /pc	NS	338,50 /pc	CR	360,30 /pc	
OL	360,30 /pc			CP	336,50 /pc					
E. 95		V-400 2FLG	1 pc	CS	314,30 /pc	NS	318,00 /pc	CR	349,00 /pc	
				OL	349,00 /pc	CP	314,30 /pc			
		V-400- 2FLG	■ min 10 pcs	CS	275,30 /pc	NS	281,30 /pc	CR	308,00 /pc	
				OL	308,00 /pc	CP	275,30 /pc			
		MV-400 2FLG 		CS	383,50 /pc	NS	386,70 /pc	CR	417,70 /pc	
OL	417,70 /pc		CP	383,50 /pc						

POS.	PROD.	ART.	Q.TÀ	FIN.	EURO	FIN.	EURO	FIN.	EURO		
V-100 ONE ▶ INDOOR 117											
E. 96		V-100	1 pc	CS	190,50 /pc	NS	192,00 /pc	CR	211,30 /pc		
				OL	211,30 /pc						
		V-100	■ min 10 pcs	CS	170,50 /pc	NS	177,30 /pc	CR	196,70 /pc		
				OL	196,70 /pc						
		MV-100		CS	250,30 /pc	NS	251,30 /pc	CR	271,00 /pc		
				OL	271,00 /pc						
E. 97	V-100 PZ V-100 BB 	V-100 PZ V-100 BB	1 pc	CS	192,50 /pc	NS	192,50 /pc	CR	213,30 /pc		
				OL	213,30 /pc						
		V-100-PZ V-100-BB	■ min 10 pcs	CS	173,50 /pc	NS	173,50 /pc	CR	197,00 /pc		
				OL	197,00 /pc						
		MV-100 PZ		CS	252,00 /pc	NS	252,00 /pc	CR	272,50 /pc		
				OL	272,50 /pc						
				<ul style="list-style-type: none"> • con vetro 8/10 mm cilindri adatti (pag. 387) • with glass 8/10 mm. suitable cylinders (page 387) • mit Glas 8/10 mm. Lieferbare Zylinder (Seite 387) 		C-01 C-02 C-03 C-04					
E. 98		V-100-P	1 pc	CS	337,50 /pc	NS	338,50 /pc	CR	384,50 /pc		
				OL	384,50 /pc						
		V-100-P	■ min 10 pcs	CS	287,00 /pc	NS	288,00 /pc	CR	358,00 /pc		
				OL	358,00 /pc						
E. 99		V-100 2FLG	1 pc	CS	275,30 /pc	NS	281,30 /pc	CR	308,00 /pc		
				OL	308,00 /pc						
		V-100 2FLG	■ min 10 pcs	CS	259,70 /pc	NS	266,30 /pc	CR	276,00 /pc		
				OL	276,00 /pc						
		MV-100 2FLG		CS	JDF /pc	NS	JDG /pc	CR	JDH /pc		
				OL	JDI /pc						
V-770 SECUR ▶ INDOOR 116											
E. 100	 B DESTRA/RIGHT/RECHTS D DESTRA/RIGHT/RECHTS A SINISTRA/LEFT/LINKS C SINISTRA/LEFT/LINKS 	V-770 PZ-R V-770 PZ-L	1 pc	CS	300,30 /pc	NS	310,30 /pc	CR	325,30 /pc		
				OL	325,30 /pc	CP	300,30 /pc				
						<ul style="list-style-type: none"> • con vetro 8/10 mm cilindri adatti (pag. 387) • with glass 8/10 mm. suitable cylinders (page 387) • mit Glas 8/10 mm. Lieferbare Zylinder (Seite 387) 		C-08 C-09			
						<ul style="list-style-type: none"> • SPECIFICARE SE PER APERTURA DESTRA O SINISTRA • PLEASE SPECIFY ALWAYS OPENING DIRECTION • BITTE IMMER ÖFFNUNGSRICHTUNG ANGEBEN 					

- Confezioni industriali
- Industrial packaging
- Industrieverpackungen

- **min**
- Prezzi speciali per l'acquisto delle quantità minime indicate dell'articolo. NB eventuali riordini o aggiunte per completamenti se di quantità inferiore alla minima, saranno fatturati al prezzo normale.
- Special prices for the purchase of the minimum quantities indicated of the article. Note Well: any reorders or additions for completions of quantity less than the minimum will be invoiced at the normal price.
- Artikel mit Sonderpreisen bei Mindestabnahmemengen sind mit gekennzeichnet. Nachbestellungen oder Ergänzungen unter der Mindestabnahmemenge werden mit dem Normalpreis verrechnet.

MV

- Versione Magnetica compresa di contropiastra magnetica finitura:CS
- Magnetic version with magnetic strike plate included in finish CS
- Mit magnetischen Schließvorgang inkl. magnetische Schließblech CS



POS.	PROD.	ART.	Q.TÀ	FIN.	EURO	FIN.	EURO	FIN.	EURO		
E. 101	 V-770 BB-R V-770 BB-L	1 pc	CS	300,30	/pc	NS	310,30	/pc	CR	325,30	/pc
			OL	325,30	/pc	CP	300,30	/pc			
E. 102	 V-770 WC-R V-770 WC-L	1 pc	CS	325,30	/pc	NS	335,30	/pc	CR	350,30	/pc
			OL	350,30	/pc	CP	325,30	/pc			
<p>• SPECIFICARE SE PER APERTURA DESTRA O SINISTRA • PLEASE SPECIFY ALWAYS OPENING DIRECTION • BITTE IMMER ÖFFNUNGSRICHTUNG ANGEBEN</p>											
E. 103	 x V-770 R V-770 2FLG-L	1 pc	CS	399,00	/pc	NS	409,70	/pc	CR	424,70	/pc
			OL	424,70	/pc	CP	399,00	/pc			
E. 104	 x V-770 L V-770 2FLG-R	1 pc	CS	399,00	/pc	NS	409,70	/pc	CR	424,70	/pc
			OL	424,70	/pc	CP	399,00	/pc			
ELEGANT										▶ INDOOR 96	
E. 105	 V-724 PZ	1 pc	CS	126,00	/pc	NS	125,00	/pc	CP	126,00	/pc
			CR	128,70	/pc						
	 V-724 PZ	min 10 pcs	CS	115,00	/pc	NS	114,00	/pc	CP	115,00	/pc
			CR	117,50	/pc						
E. 106	 V-725 PZ	1 pc	CS	126,00	/pc	NS	125,00	/pc	CP	126,00	/pc
			CR	128,70	/pc						
	 V-725 PZ	min 10 pcs	CS	115,00	/pc	NS	114,00	/pc	CP	115,00	/pc
			CR	117,50	/pc						
E. 107	 V-726 PZ	1 pc	CS	126,00	/pc	NS	125,00	/pc	CP	126,00	/pc
			CR	128,70	/pc						
	 V-726 PZ	min 10 pcs	CS	115,00	/pc	NS	114,00	/pc	CP	115,00	/pc
			CR	117,50	/pc						

POS.	PROD.	ART.	Q.TÀ	FIN.	EURO	FIN.	EURO	FIN.	EURO
E. 108		V-724 2FLG	1 pc	CS	109,30 /pc	NS	108,30 /pc	CP	109,30 /pc
				CR	111,30 /pc				
		V-724 2FLG	■ min 10 pcs	CS	101,30 /pc	NS	100,00 /pc	CP	101,30 /pc
				CR	103,50 /pc				
E. 109		V-725 2FLG	1 pc	CS	109,30 /pc	NS	108,30 /pc	CP	109,30 /pc
				CR	111,30 /pc				
		V-725 2FLG	■ min 10 pcs	CS	101,30 /pc	NS	100,00 /pc	CP	101,30 /pc
				CR	103,50 /pc				
E. 110		V-726 2FLG	1 pc	CS	109,30 /pc	NS	108,30 /pc	CP	109,30 /pc
				CR	111,30 /pc				
		V-726 2FLG	■ min 10 pcs	CS	101,30 /pc	NS	100,00 /pc	CP	101,30 /pc
				CR	103,50 /pc				
E. 111		C-06	1 pc	CR	29,70 /pc				
E. 112		C-018	1 pc	CS	46,00 /pc	CR	46,00 /pc	NS	46,00 /pc
				CP	46,00 /pc				
E. 113		C-016	1 pc	CS	76,70 /pc	CR	76,70 /pc	NS	76,70 /pc
				CP	76,70 /pc				
E. 114		V-022	1 pc	CS	18,50 /pc	NS	18,50 /pc	CR	36,70 /pc
E. 115		V-023	1 pc	CS	32,00 /pc	NS	36,70 /pc	CR	36,70 /pc
E. 116		V-002	1 pc	CR	18,70 /pc				
E. 117		V-504-SP12	1 pc		28,00 /pc				

- Confezioni industriali
- Industrial packaging
- Industrieverpackungen

- **min**
- Prezzi speciali per l'acquisto delle quantità minime indicate dell'articolo.
NB eventuali riordini o aggiunte per completamenti se di quantità inferiore alla minima, saranno fatturati al prezzo normale
- Special prices for the purchase of the minimum quantities indicated of the article.
Note Well: any reorders or additions for completions of quantity less than the minimum will be invoiced at the normal price.
- Artikel mit Sonderpreisen bei Mindestabnahmemengen sind mit gekennzeichnet.
Nachbestellungen oder Ergänzungen unter der Mindestabnahmemenge werden mit dem Normalpreis verrechnet.

POS.	PROD.	ART.	Q.TÀ	FIN.	EURO	FIN.	EURO	FIN.	EURO
ELEGANT LEVER									
E. 118		V-744 PZ	1 pc	CS	162,00 /pc	NS	159,70 /pc	CP	162,00 /pc
				CR	164,00 /pc				
		V-744 PZ	■ min 10 pcs	CS	139,00 /pc	NS	138,70 /pc	CP	139,00 /pc
				CR	149,00 /pc				
E. 119		V-745 PZ	1 pc	CS	162,00 /pc	NS	159,70 /pc	CP	162,00 /pc
				CR	164,00 /pc				
		V-745 PZ	■ min 10 pcs	CS	139,00 /pc	NS	138,70 /pc	CP	139,00 /pc
				CR	149,00 /pc				
E. 120		V-746 PZ	1 pc	CS	162,00 /pc	NS	159,70 /pc	CP	162,00 /pc
				CR	164,00 /pc				
		V-746 PZ	■ min 10 pcs	CS	139,00 /pc	NS	138,70 /pc	CP	139,00 /pc
				CR	149,00 /pc				
E. 121		V-744 2FLG	1 pc	CS	162,00 /pc	NS	159,70 /pc	CP	162,00 /pc
				CR	164,00 /pc				
		V-744 2FLG	■ min 10 pcs	CS	139,00 /pc	NS	138,70 /pc	CP	139,00 /pc
				CR	149,00 /pc				
E. 122		V-745 2FLG	1 pc	CS	162,00 /pc	NS	159,70 /pc	CP	162,00 /pc
				CR	164,00 /pc				
		V-745 2FLG	■ min 10 pcs	CS	139,00 /pc	NS	138,70 /pc	CP	139,00 /pc
				CR	149,00 /pc				
E. 123		V-746 2FLG	1 pc	CS	162,00 /pc	NS	159,70 /pc	CP	162,00 /pc
				CR	164,00 /pc				
		V-726 2FLG	■ min 10 pcs	CS	139,00 /pc	NS	138,70 /pc	CP	139,00 /pc
				CR	149,00 /pc				
E. 124		C-014	1 pc	CR	32,00 /pc				
E. 125		C-013	1 pc	CS	47,00 /pc	CR	47,00 /pc	NS	47,00 /pc
				CP	47,00 /pc				

POS.	PROD.	ART.	Q.TÀ	FIN.	EURO	FIN.	EURO	FIN.	EURO
E. 126		C-08-Q	1 pc	CS	49,30 /pc	CR	49,30 /pc	NS	49,30 /pc
				CP	49,30 /pc				
E. 127		V-022	1 pc	CS	18,50 /pc	NS	18,50 /pc	CR	36,70 /pc
E. 128		V-023	1 pc	CS	32,00 /pc	NS	36,70 /pc	CR	36,70 /pc
E. 129		V-002	1 pc	CR	18,70 /pc				
E. 130		V-504-SP12	1 pc		28,00 /pc				
ELEGANT LEVER COLOR									▶ INDOOR 93
E. 131		V-744 COLOR	1 pc	CS	224,00 /pc	NS	222,70 /pc	CP	224,00 /pc
		V-744 COLOR	■ min 10 pcs	CR	232,30 /pc				
E. 132		V-745 COLOR	1 pc	CS	194,30 /pc	NS	193,00 /pc	CP	194,30 /pc
		V-745 COLOR	■ min 10 pcs	CR	202,00 /pc				
E. 133		V-746 COLOR	1 pc	CS	224,00 /pc	NS	222,70 /pc	CP	224,00 /pc
		V-746 COLOR	■ min 10 pcs	CR	232,30 /pc				

- Confezioni industriali
- Industrial packaging
- Industrieverpackungen

■ min

- Prezzi speciali per l'acquisto delle quantità minime indicate dell'articolo. NB eventuali riordini o aggiunte per completamenti se di quantità inferiore alla minima, saranno fatturati al prezzo normale
- Special prices for the purchase of the minimum quantities indicated of the article. Note Well: any reorders or additions for completions of quantity less than the minimum will be invoiced at the normal price.
- Artikel mit Sonderpreisen bei Mindestabnahmemengen sind mit gekennzeichnet. Nachbestellungen oder Ergänzungen unter der Mindestabnahmemenge werden mit dem Normalpreis verrechnet.

POS.	PROD.	ART.	Q.TÀ	FIN.	EURO	FIN.	EURO	FIN.	EURO
E. 134		V-744 2FLG	1 pc	CS	162,00 /pc	NS	159,70 /pc	CP	162,00 /pc
				CR	164,00 /pc				
		V-744 2FLG	■ min 10 pcs	CS	139,00 /pc	NS	138,70 /pc	CP	139,00 /pc
				CR	149,00 /pc				
E. 135		V-745 2FLG	1 pc	CS	162,00 /pc	NS	159,70 /pc	CP	162,00 /pc
				CR	164,00 /pc				
		V-745 2FLG	■ min 10 pcs	CS	139,00 /pc	NS	138,70 /pc	CP	139,00 /pc
				CR	149,00 /pc				
E. 136		V-746 2FLG	1 pc	CS	162,00 /pc	NS	159,70 /pc	CP	162,00 /pc
				CR	164,00 /pc				
		V-726 2FLG	■ min 10 pcs	CS	139,00 /pc	NS	138,70 /pc	CP	139,00 /pc
				CR	149,00 /pc				
E. 137		V-022	1 pc	CS	18,50 /pc	NS	18,50 /pc	CR	36,70 /pc
E. 138		V-023	1 pc	CS	32,00 /pc	NS	36,70 /pc	CR	36,70 /pc
E. 139		V-002	1 pc	CR	18,70 /pc				
E. 140		V-504-SP12	1 pc		28,00 /pc				
ELEGANT DRAG									► INDOOR 94
E. 141		V-734 PZ	1 pc	CS	166,50 /pc	NS	159,70 /pc	CP	166,50 /pc
				CR	166,50 /pc				
		V-734 PZ	■ min 10 pcs	CS	144,70 /pc	NS	138,70 /pc	CP	144,70 /pc
				CR	151,70 /pc				
E. 142		V-735 PZ	1 pc	CS	166,50 /pc	NS	159,70 /pc	CP	166,50 /pc
				CR	166,50 /pc				
		V-735 PZ	■ min 10 pcs	CS	144,70 /pc	NS	138,70 /pc	CP	144,70 /pc
				CR	151,70 /pc				

POS.	PROD.	ART.	Q.TÀ	FIN.	EURO	FIN.	EURO	FIN.	EURO
E. 143		V-736 PZ	1 pc	CS	166,50 /pc	NS	159,70 /pc	CP	166,50 /pc
		V-736 PZ	■ min 10 pcs	CR	166,50 /pc				
E. 144		V-734 2FLG	1 pc	CS	144,70 /pc	NS	138,70 /pc	CP	144,70 /pc
		V-734 2FLG	■ min 10 pcs	CR	151,70 /pc				
E. 145		V-735 2FLG	1 pc	CS	166,50 /pc	NS	159,70 /pc	CP	166,50 /pc
		V-735 2FLG	■ min 10 pcs	CR	166,50 /pc				
E. 146		V-736 2FLG	1 pc	CS	144,70 /pc	NS	138,70 /pc	CP	144,70 /pc
		V-736 2FLG	■ min 10 pcs	CR	151,70 /pc				
E. 147		C-014	1 pc	CR	32,00 /pc				
E. 148		C-013	1 pc	CS	47,00 /pc	CR	47,00 /pc	NS	47,00 /pc
E. 149		C-08-Q	1 pc	CP	47,00 /pc				
E. 150		V-022	1 pc	CS	49,30 /pc	CR	49,30 /pc	NS	49,30 /pc
E. 151		V-023	1 pc	CS	18,50 /pc	NS	18,50 /pc	CR	36,70 /pc
E. 152		V-002	1 pc	CS	32,00 /pc	NS	36,70 /pc	CR	36,70 /pc
E. 152		V-002	1 pc	CR	18,70 /pc				

- Confezioni industriali
- Industrial packaging
- Industrieverpackungen

- **min**
 - Prezzi speciali per l'acquisto delle quantità minime indicate dell'articolo. NB eventuali riordini o aggiunte per completamenti se di quantità inferiore alla minima, saranno fatturati al prezzo normale
 - Special prices for the purchase of the minimum quantities indicated of the article. Note Well: any reorders or additions for completions of quantity less than the minimum will be invoiced at the normal price.
 - Artikel mit Sonderpreisen bei Mindestabnahmemengen sind mit gekennzeichnet. Nachbestellungen oder Ergänzungen unter der Mindestabnahmemenge werden mit dem Normalpreis verrechnet.



POS.	PROD.	ART.	Q.TÀ	FIN.	EURO	FIN.	EURO	FIN.	EURO
E. 153		V-504-SP12	1 pc		28,00 /pc				
ELEGANT DRAG COLOR ▶ INDOOR 96									
E. 154		V-734 COLOR	1 pc	CS	235,50 /pc	NS	234,30 /pc	CP	235,50 /pc
				CR	244,50 /pc				
		V-734 COLOR	■ min 10 pcs	CS	198,70 /pc	NS	197,50 /pc	CP	198,70 /pc
				CR	206,70 /pc				
E. 155		V-735 COLOR	1 pc	CS	235,50 /pc	NS	234,30 /pc	CP	235,50 /pc
				CR	244,50 /pc				
		V-735 COLOR	■ min 10 pcs	CS	198,70 /pc	NS	197,50 /pc	CP	198,70 /pc
				CR	206,70 /pc				
E. 156		V-736 COLOR	1 pc	CS	235,50 /pc	NS	234,30 /pc	CP	235,50 /pc
				CR	244,50 /pc				
		V-736 COLOR	■ min 10 pcs	CS	198,70 /pc	NS	197,50 /pc	CP	198,70 /pc
				CR	206,70 /pc				
E. 157		V-734 2FLG	1 pc	CS	166,50 /pc	NS	159,70 /pc	CP	166,50 /pc
				CR	166,50 /pc				
		V-734 2FLG	■ min 10 pcs	CS	144,70 /pc	NS	138,70 /pc	CP	144,70 /pc
				CR	151,70 /pc				
E. 158		V-735 2FLG	1 pc	CS	166,50 /pc	NS	159,70 /pc	CP	166,50 /pc
				CR	166,50 /pc				
		V-735 2FLG	■ min 10 pcs	CS	144,70 /pc	NS	138,70 /pc	CP	144,70 /pc
				CR	151,70 /pc				
E. 159		V-736 2FLG	1 pc	CS	166,50 /pc	NS	159,70 /pc	CP	166,50 /pc
				CR	166,50 /pc				
		V-736 2FLG	■ min 10 pcs	CS	144,70 /pc	NS	138,70 /pc	CP	144,70 /pc
				CR	151,70 /pc				
E. 160		V-022	1 pc	CS	18,50 /pc	NS	18,50 /pc	CR	36,70 /pc

POS.	PROD.	ART.	Q.TÀ	FIN.	EURO	FIN.	EURO	FIN.	EURO
E. 161		V-023	1 pc	CS	32,00 /pc	NS	36,70 /pc	CR	36,70 /pc
E. 162		V-002	1 pc	CR	18,70 /pc				
E. 163		V-504-SP12	1 pc		28,00 /pc				
V-504 V-505 V-515 MINIMA									► INDOOR 98
E. 164	 NOT INCLUDED	V-504 NC	1 pc	CS	157,50 /pc	NS	157,50 /pc	CR	166,50 /pc
				OL	191,30 /pc	CP	157,50 /pc	NO	176,30 /pc
		V-504 NC	■ min 10 pcs	CS	137,30 /pc	NS	137,30 /pc	CR	149,30 /pc
				OL	179,30 /pc	CP	137,30 /pc	NO	154,30 /pc
E. 165		V-505	1 pc	CS	157,50 /pc	NS	157,50 /pc	CR	166,50 /pc
				OL	191,30 /pc	CP	157,50 /pc	NO	176,30 /pc
		V-505	■ min 10 pcs	CS	137,30 /pc	NS	137,30 /pc	CR	149,30 /pc
				OL	179,30 /pc	CP	137,30 /pc	NO	154,30 /pc
E. 166		V-515	1 pc	CS	147,70 /pc	NS	157,50 /pc	CR	166,50 /pc
				OL	191,30 /pc	CP	157,50 /pc	NO	176,30 /pc
		V-515	■ min 10 pcs	CS	137,30 /pc	NS	137,70 /pc	CR	149,30 /pc
				OL	179,30 /pc	CP	137,30 /pc	NO	154,30 /pc
E. 167		V-504 2FLG	1 pc	CS	188,70 /pc	NS	188,70 /pc	CR	197,30 /pc
				OL	226,00 /pc	CP	188,70 /pc	NO	211,00 /pc
		V-504 2FLG	■ min 10 pcs	CS	176,70 /pc	NS	176,70 /pc	CR	185,30 /pc
				OL	214,00 /pc	CP	176,70 /pc	NO	198,00 /pc
E. 168		V-505 2FLG	1 pc	CS	157,50 /pc	NS	157,50 /pc	CR	166,50 /pc
				OL	226,00 /pc	CP	157,50 /pc	NO	176,30 /pc
		V-505 2FLG	■ min 10 pcs	CS	137,30 /pc	NS	137,30 /pc	CR	149,30 /pc
				OL	179,30 /pc	CP	137,30 /pc	NO	154,30 /pc
E. 169		V-515 2FLG	1 pc	CS	188,70 /pc	NS	188,70 /pc	CR	197,30 /pc
				OL	226,00 /pc	CP	188,70 /pc	NO	211,00 /pc
		V-515 2FLG	■ min 10 pcs	CS	176,70 /pc	NS	176,70 /pc	CR	185,30 /pc
				OL	214,00 /pc	CP	176,70 /pc	NO	198,00 /pc

- Confezioni industriali
- Industrial packaging
- Industrieverpackungen

■ **min**

- Prezzi speciali per l'acquisto delle quantità minime indicate dell'articolo. NB eventuali riordini o aggiunte per completamenti se di quantità inferiore alla minima, saranno fatturati al prezzo normale
- Special prices for the purchase of the minimum quantities indicated of the article. Note Well: any reorders or additions for completions of quantity less than the minimum will be invoiced at the normal price.
- Artikel mit Sonderpreisen bei Mindestabnahmemengen sind mit gekennzeichnet. Nachbestellungen oder Ergänzungen unter der Mindestabnahmemenge werden mit dem Normalpreis verrechnet.

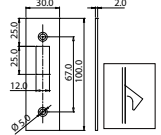
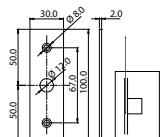
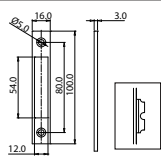
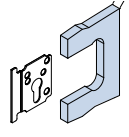
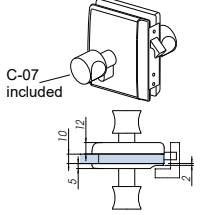
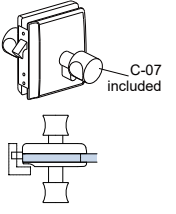
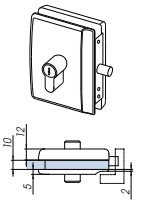
POS.	PROD.	ART.	Q.TÀ	FIN.	EURO	FIN.	EURO	FIN.	EURO	
E. 170		C-07	1 pc	CS	92,00 /pc	CR	92,00 /pc	NS	92,00 /pc	
				CP	92,00 /pc					
E. 171		C-06	1 pc	CR	29,70 /pc					
<ul style="list-style-type: none"> • Altri cilindri adatti C-01, C-02, C-03, C-05 vedi pag. 387 • Other suitable cylinders C-01, C-02, C-03, C-05 see page 387 • Andere Lieferbare Zylinder C-01, C-02, C-03, C-05 Seite 387 										
E. 172		V-022	1 pc	CS	18,50 /pc	NS	18,50 /pc	CR	36,70 /pc	
E. 173		V-023	1 pc	CS	32,00 /pc	NS	36,70 /pc	CR	36,70 /pc	
E. 174		V-002	1 pc	CR	18,70 /pc					
E. 175		V-504-SP12	1 pc		28,00 /pc					
99	V-518 V-519 V-520 MINIMA BATTUTA								▶ INDOOR 99	
E. 176		V-518 DX	1 pc	CS	311,50 /pc	NS	323,70 /pc	CR	336,50 /pc	
				CP	314,30 /pc					
<ul style="list-style-type: none"> • con vetro 8/10 mm cilindri adatti (pag. 387) • with glass 8/10 mm. suitable cylinders (page 387) • mit Glas 8/10 mm. Lieferbare Zylinder (Seite 387) 										
E. 177		V-518 SX	1 pc	CS	311,50 /pc	NS	323,70 /pc	CR	336,50 /pc	
				CP	314,30 /pc					
<ul style="list-style-type: none"> • con vetro 8/10 mm cilindri adatti (pag. 387) • with glass 8/10 mm. suitable cylinders (page 387) • mit Glas 8/10 mm. Lieferbare Zylinder (Seite 387) 										
E. 178		V-519 DX	1 pc	CS	195,50 /pc	NS	204,70 /pc	CR	219,00 /pc	
				CP	198,30 /pc					
<ul style="list-style-type: none"> • con vetro 8/10 mm cilindri adatti (pag. 387) • with glass 8/10 mm. suitable cylinders (page 387) • mit Glas 8/10 mm. Lieferbare Zylinder (Seite 387) 										

POS.	PROD.	ART.	Q.TÀ	FIN.	EURO	FIN.	EURO	FIN.	EURO
E. 179		V-519 SX	1 pc	CS	195,50 /pc	NS	204,70 /pc	CR	219,00 /pc
				CP	198,30 /pc				
				<ul style="list-style-type: none"> • con vetro 8/10 mm cilindri adatti (pag. 387) • with glass 8/10 mm. suitable cylinders (page 387) • mit Glas 8/10 mm. Lieferbare Zylinder (Seite 387) 		C-01 C-02 C-03 C-05 C-06 C-07			
E. 180		V-520 DX	1 pc	CS	195,50 /pc	NS	204,70 /pc	CR	219,00 /pc
				CP	198,30 /pc				
				<ul style="list-style-type: none"> • con vetro 8/10 mm cilindri adatti (pag. 387) • with glass 8/10 mm. suitable cylinders (page 387) • mit Glas 8/10 mm. Lieferbare Zylinder (Seite 387) 		C-01 C-02 C-03 C-05 C-06 C-07			
E. 181		V-520 SX	1 pc	CS	195,50 /pc	NS	204,70 /pc	CR	219,00 /pc
				CP	198,30 /pc				
				<ul style="list-style-type: none"> • con vetro 8/10 mm cilindri adatti (pag. 387) • with glass 8/10 mm. suitable cylinders (page 387) • mit Glas 8/10 mm. Lieferbare Zylinder (Seite 387) 		C-01 C-02 C-03 C-05 C-06 C-07			
E. 182		V-504-SP12	1 pc		28,00 /pc				
V-554 V-555 V-557 MINIMA BOTTE									► INDOOR 100
E. 183		V-554 NC	1 pc	CS	235,50 /pc	NS	243,30 /pc	CR	254,00 /pc
				OL	241,70 /pc	CP	229,00 /pc		
E. 184		V-557	1 pc	CS	202,50 /pc	NS	210,50 /pc	CR	222,00 /pc
				OL	222,00 /pc	CP	202,50 /pc		
E. 185		V-555	1 pc	CS	202,50 /pc	NS	210,50 /pc	CR	222,00 /pc
				OL	222,00 /pc	CP	202,50 /pc		
E. 186		V-554 2FLG	1 pc	CS	202,50 /pc	NS	210,50 /pc	CR	222,00 /pc
				OL	222,00 /pc	CP	202,50 /pc		

POS.	PROD.	ART.	Q.TÀ	FIN.	EURO	FIN.	EURO	FIN.	EURO
E. 187		V-557 2FLG	1 pc	CS	202,50 /pc	NS	210,50 /pc	CR	222,00 /pc
				OL	222,00 /pc	CP	202,50 /pc		
E. 188		C-06	1 pc	CR	29,70 /pc				
E. 189		C-08	1 pc	CS	57,70 /pc	CR	57,70 /pc	NS	57,70 /pc
				CP	57,70 /pc				
E. 190		V-022	1 pc	CS	18,50 /pc	NS	18,50 /pc	CR	36,70 /pc
E. 191		V-023	1 pc	CS	32,00 /pc	NS	36,70 /pc	CR	36,70 /pc
E. 192		V-002	1 pc	CR	18,70 /pc				
V-529 V-530 CONTROSERRATURA									► INDOOR 101
E. 193		V-529	1 pc	CS	230,70 /pc	NS	242,50 /pc	CR	262,00 /pc
				CP	233,30 /pc				
E. 194		V-530	1 pc	CS	303,00 /pc	NS	319,00 /pc	CR	337,50 /pc
				CP	305,70 /pc				
E.194.1		V-531	1 pc						

POS.	PROD.	ART.	Q.TÀ	FIN.	EURO	FIN.	EURO	FIN.	EURO
MINIMA 55 ▶ INDOOR 104									
E. 195		V-564	1 pc	NS	146,70 /pc	CP	143,30 /pc	CR	146,70 /pc
		V-564	■ min 10 pcs	NS	119,30 /pc	CP	117,50 /pc	CR	119,30 /pc
E. 196		V-565	1 pc	NS	146,70 /pc	CP	143,30 /pc	CR	146,70 /pc
		V-565	■ min 10 pcs	NS	119,30 /pc	CP	117,50 /pc	CR	119,30 /pc
E. 197		V-569 2FLG	1 pc	NS	146,70 /pc	CP	143,30 /pc	CR	146,70 /pc
		V-569 2FLG	■ min 10 pcs	NS	119,30 /pc	CP	117,50 /pc	CR	119,30 /pc
E. 198		C-010	1 pc	CR	28,00 /pc				
E. 199		C-011	1 pc	NS	57,00 /pc	CR	64,50 /pc	CP	62,00 /pc
E. 200		C-012	1 pc	NS	63,30 /pc	CR	70,70 /pc	CP	68,30 /pc
E. 201		V-568	1 pc	IX	15,50 /pc				
E. 202		V-567-DX	1 pc	AN	23,00 /pc				
E. 203		V-567-SX	1 pc	AN	23,00 /pc				
E. 204		V-566	1 pc		12,50 /pc				

- Confezioni industriali
- Industrial packaging
- Industrieverpackungen

■ **min**

- Prezzi speciali per l'acquisto delle quantità minime indicate dell'articolo. NB eventuali riordini o aggiunte per completamenti se di quantità inferiore alla minima, saranno fatturati al prezzo normale
- Special prices for the purchase of the minimum quantities indicated of the article. Note Well: any reorders or additions for completions of quantity less than the minimum will be invoiced at the normal price.
- Artikel mit Sonderpreisen bei Mindestabnahmemengen sind mit gekennzeichnet. Nachbestellungen oder Ergänzungen unter der Mindestabnahmemenge werden mit dem Normalpreis verrechnet.

POS.	PROD.	ART.	Q.TÀ	FIN.	EURO	FIN.	EURO	FIN.	EURO
MINIMA 55 COLOR ▶ INDOOR 105									
E. 205		V-564 COLOR	1 pc	NS	184,50 /pc	CP	180,00 /pc	CR	185,00 /pc
		V-564 COLOR	■ min 10 pcs	NS	162,50 /pc	CP	159,00 /pc	CR	162,50 /pc
E. 206		V-565 COLOR	1 pc	NS	184,50 /pc	CP	180,00 /pc	CR	185,00 /pc
		V-565 COLOR	■ min 10 pcs	NS	162,50 /pc	CP	159,00 /pc	CR	162,50 /pc
E. 207		V-569 2FLG	1 pc	NS	146,70 /pc	CP	143,30 /pc	CR	146,70 /pc
		V-569 2FLG	■ min 10 pcs	NS	119,30 /pc	CP	117,50 /pc	CR	119,30 /pc
E. 208		V-568	1 pc	IX	15,50 /pc				
E. 209		V-567-DX	1 pc	AN	23,00 /pc				
E. 210		V-567-SX	1 pc	AN	23,00 /pc				
E. 211		V-566	1 pc		12,50 /pc				
MINIMA 55 LEVER ▶ INDOOR 106									
E. 212		V-584	1 pc	NS	226,50 /pc	CP	214,70 /pc	CR	218,70 /pc
		V-584	■ min 10 pcs	NS	201,00 /pc	CP	190,00 /pc	CR	175,70 /pc

POS.	PROD.	ART.	Q.TÀ	FIN.	EURO	FIN.	EURO	FIN.	EURO
E. 213		V-585	1 pc	NS	226,50 /pc	CP	214,70 /pc	CR	218,70 /pc
		V-585	■ min 10 pcs	NS	201,00 /pc	CP	190,00 /pc	CR	175,70 /pc
E. 214		V-569 2FLG	1 pc	NS	146,70 /pc	CP	143,30 /pc	CR	146,70 /pc
		V-569 2FLG	■ min 10 pcs	NS	119,30 /pc	CP	117,50 /pc	CR	119,30 /pc
E. 215		C-020	1 pc	CR	28,00 /pc				
E. 216		C-021	1 pc	NS	57,00 /pc	CR	64,50 /pc	CP	62,00 /pc
E. 217		C-019	1 pc	NS	63,30 /pc	CR	70,70 /pc	CP	68,30 /pc
E. 218		V-568	1 pc	IX	15,50 /pc				
E. 219		V-567-DX	1 pc	AN	23,00 /pc				
E. 220		V-567-SX	1 pc	AN	23,00 /pc				
E. 221		V-566	1 pc		12,50 /pc				
MINIMA 55 LEVER COLOR									► INDOOR 107
E. 222		V-584 COLOR	1 pc	NS	253,70 /pc	CP	250,00 /pc	CR	258,50 /pc
		V-584 COLOR	■ min 10 pcs	NS	220,00 /pc	CP	216,70 /pc	CR	224,30 /pc

- Confezioni industriali
- Industrial packaging
- Industrieverpackungen

■ **min**

- Prezzi speciali per l'acquisto delle quantità minime indicate dell'articolo. NB eventuali riordini o aggiunte per completamenti se di quantità inferiore alla minima, saranno fatturati al prezzo normale
- Special prices for the purchase of the minimum quantities indicated of the article. Note Well: any reorders or additions for completions of quantity less than the minimum will be invoiced at the normal price.
- Artikel mit Sonderpreisen bei Mindestabnahmemengen sind mit gekennzeichnet. Nachbestellungen oder Ergänzungen unter der Mindestabnahmemenge werden mit dem Normalpreis verrechnet.

POS.	PROD.	ART.	Q.TÀ	FIN.	EURO	FIN.	EURO	FIN.	EURO
E. 223		V-585 COLOR	1 pc	NS	253,70 /pc	CP	250,00 /pc	CR	258,50 /pc
		V-585 COLOR	■ min 10 pcs	NS	220,00 /pc	CP	216,70 /pc	CR	224,30 /pc
E. 224		V-569 2FLG	1 pc	NS	146,70 /pc	CP	143,30 /pc	CR	146,70 /pc
		V-569 2FLG	■ min 10 pcs	NS	119,30 /pc	CP	117,50 /pc	CR	119,30 /pc
E. 225		V-568	1 pc	IX	15,50 /pc				
E. 226		V-567-DX	1 pc	AN	23,00 /pc				
E. 227		V-567-SX	1 pc	AN	23,00 /pc				
E. 228		V-566	1 pc		12,50 /pc				
MINIMA 55 DRAG									▶ INDOOR 108
E. 229		V-594	1 pc	NS	193,50 /pc	CP	187,30 /pc	CR	191,00 /pc
		V-594	■ min 10 pcs	NS	169,00 /pc	CP	162,50 /pc	CR	165,50 /pc
E. 230		V-569 2FLG	1 pc	NS	146,70 /pc	CP	143,30 /pc	CR	146,70 /pc
		V-569 2FLG	■ min 10 pcs	NS	119,30 /pc	CP	117,50 /pc	CR	119,30 /pc
E. 231		C-020	1 pc	CR	28,00 /pc				

POS.	PROD.	ART.	Q.TÀ	FIN.	EURO	FIN.	EURO	FIN.	EURO
E. 232		C-021	1 pc	NS	57,00 /pc	CR	64,50 /pc	CP	62,00 /pc
E. 233		C-019	1 pc	NS	63,30 /pc	CR	70,70 /pc	CP	68,30 /pc
E. 234		V-568	1 pc	IX	15,50 /pc				
E. 235		V-567-DX	1 pc	AN	23,00 /pc				
E. 236		V-567-SX	1 pc	AN	23,00 /pc				
E. 237		V-566	1 pc		12,50 /pc				
MINIMA 55 DRAG COLOR									► INDOOR 109
E. 238		V-594 COLOR	1 pc	NS	232,50 /pc	CP	226,50 /pc	CR	231,50 /pc
		V-594 COLOR	■ min 10 pcs	NS	202,00 /pc	CP	190,00 /pc	CR	198,30 /pc
E. 239		V-569 2FLG	1 pc	NS	146,70 /pc	CP	143,30 /pc	CR	146,70 /pc
		V-569 2FLG	■ min 10 pcs	NS	119,30 /pc	CP	117,50 /pc	CR	119,30 /pc
E. 240		V-568	1 pc	IX	15,50 /pc				
E. 241		V-567-DX	1 pc	AN	23,00 /pc				
E. 242		V-567-SX	1 pc	AN	23,00 /pc				

- Confezioni industriali
- Industrial packaging
- Industrieverpackungen

■ min

- Prezzi speciali per l'acquisto delle quantità minime indicate dell'articolo. NB eventuali riordini o aggiunte per completamenti se di quantità inferiore alla minima, saranno fatturati al prezzo normale
- Special prices for the purchase of the minimum quantities indicated of the article. Note Well: any reorders or additions for completions of quantity less than the minimum will be invoiced at the normal price.
- Artikel mit Sonderpreisen bei Mindestabnahmemengen sind mit gekennzeichnet. Nachbestellungen oder Ergänzungen unter der Mindestabnahmemenge werden mit dem Normalpreis verrechnet.

POS.	PROD.	ART.	Q.TÀ	FIN.	EURO	FIN.	EURO	FIN.	EURO
E. 243		V-566	1 pc		12,50 /pc				
MINIMA 55 RIBASSATA ▶ INDOOR 110									
E. 244		V-574	1 pc	CS	135,30 /pc	NS	136,30 /pc	CP	137,30 /pc
		V-574	■ min 10 pcs	CS	114,00 /pc	NS	115,00 /pc	CP	116,30 /pc
E. 245		V-575	1 pc	CS	135,30 /pc	NS	136,30 /pc	CP	137,30 /pc
		V-575	■ min 10 pcs	CS	114,00 /pc	NS	115,00 /pc	CP	116,30 /pc
E. 246		V-569 2FLG	1 pc	NS	146,70 /pc	CP	143,30 /pc	CR	146,70 /pc
		V-569 2FLG	■ min 10 pcs	NS	119,30 /pc	CP	117,50 /pc	CR	119,30 /pc
E. 247		C-010	1 pc	CR	28,00 /pc				
E. 248		C-011	1 pc	NS	57,00 /pc	CR	64,50 /pc	CP	62,00 /pc
E. 249		C-012	1 pc	NS	63,30 /pc	CR	70,70 /pc	CP	68,30 /pc
E. 250		V-568	1 pc	IX	15,50 /pc				
E. 251		V-567-DX	1 pc	AN	23,00 /pc				
E. 252		V-567-SX	1 pc	AN	23,00 /pc				
E. 253		V-566	1 pc		12,50 /pc				

POS.	PROD.	ART.	Q.TÀ	FIN.	EURO	FIN.	EURO	FIN.	EURO
EASY LOCK									▶ INDOOR 112
E. 254		V-785	1 pc	CR	108,30 /pc	NS	112,70 /pc	CP	119,50 /pc
		V-785	■ min 10 pcs	CR	99,00 /pc	NS	103,50 /pc	CP	109,30 /pc
E. 255		V-785 COLOR	1 pc	CR	86,30 /pc	NS	91,00 /pc	CP	98,00 /pc
		V-785 COLOR	■ min 10 pcs	CR	77,50 /pc	NS	81,70 /pc	CP	88,70 /pc
E. 256		V-775	1 pc	CR	144,70 /pc	NS	150,70 /pc	CP	158,50 /pc
		V-775-CF10	■ min 10 pcs	CR	133,30 /pc	NS	139,00 /pc	CP	147,30 /pc
E. 257		V-775 COLOR	1 pc	CR	112,70 /pc	NS	117,50 /pc	CP	125,30 /pc
		V-775 COLOR	■ min 10 pcs	CR	102,30 /pc	NS	106,50 /pc	CP	114,30 /pc
E. 258		V-779 2FLG	1 pc	CR	69,30 /pc	NS	75,00 /pc	CP	78,50 /pc
		V-779 2FLG	■ min 10 pcs	CR	57,70 /pc	NS	63,30 /pc	CP	67,00 /pc
E. 259		V-776	1 pc		14,70 /pc				
V-404									▶ INDOOR 115
E. 260		V-404 PO-WC	1 pc	CP	241,50 /pc	NS	239,00 /pc	CR	252,00 /pc
		V-404 PO-WC	■ min 10 pcs	CP	193,50 /pc	NS	191,30 /pc	CR	208,00 /pc

- Confezioni industriali
- Industrial packaging
- Industrieverpackungen

■ **min**

- Prezzi speciali per l'acquisto delle quantità minime indicate dell'articolo. NB eventuali riordini o aggiunte per completamenti se di quantità inferiore alla minima, saranno fatturati al prezzo normale
- Special prices for the purchase of the minimum quantities indicated of the article. Note Well: any reorders or additions for completions of quantity less than the minimum will be invoiced at the normal price.
- Artikel mit Sonderpreisen bei Mindestabnahmemengen sind mit gekennzeichnet. Nachbestellungen oder Ergänzungen unter der Mindestabnahmemenge werden mit dem Normalpreis verrechnet.

POS.	PROD.	ART.	Q.TÀ	FIN.	EURO	FIN.	EURO	FIN.	EURO
E. 261		V-404 PO-PO	1 pc	CP	243,50 /pc	NS	241,50 /pc	CR	254,50 /pc
		V-404 PO-PO	■ min 10 pcs	CP	199,00 /pc	NS	196,70 /pc	CR	213,30 /pc
E. 262		V-404 WC COLOUR	1 pc	CP	297,70 /pc	NS	293,70 /pc	CR	303,70 /pc
		V-404 WC COLOUR	■ min 10 pcs	CP	238,30 /pc	NS	235,50 /pc	CR	251,00 /pc
E. 263		V-404 PO-2FLG	1 pc	CP	301,30 /pc	NS	297,50 /pc	CR	315,30 /pc
		V-404 PO-2FLG	■ min 10 pcs	CP	251,00 /pc	NS	247,30 /pc	CR	264,00 /pc
E. 264		V-404 2FLG	1 pc	CP	301,30 /pc	NS	297,50 /pc	CR	315,30 /pc
		V-404 2FLG	■ min 10 pcs	CP	251,00 /pc	NS	247,30 /pc	CR	264,00 /pc
E. 265		V-404-SP12	1 pc		27,30 /pc				
V-604								▶ INDOOR 117	
E. 266		V-604 LE-LE	1 pc	NS	317,00 /pc	CP	307,50 /pc		

POS.	PROD.	ART.	Q.TÀ	FIN.	EURO	FIN.	EURO	FIN.	EURO
E. 267		V-604 LE-PO	1 pc	NS	317,00 /pc	CP	307,50 /pc		
E. 268		V-604 CH-LE	1 pc	NS	275,30 /pc	CP	265,50 /pc		
E. 269		V-407-604-SP12	1 pc		27,30 /pc				
E. 270		V-604 CH-PO	1 pc	NS	275,30 /pc	CP	265,50 /pc		
E. 271		V-604 PO-PO	1 pc	NS	317,00 /pc	CP	307,50 /pc		
E. 272		V-604 CH-WC	1 pc	NS	253,00 /pc	CP	242,50 /pc		
		<ul style="list-style-type: none"> • Contropiastra inclusa • Strike plate included • Schließblech im Set enthalten 							
E. 273		V-604 WC-PO	1 pc	NS	289,30 /pc	CP	280,00 /pc		
		<ul style="list-style-type: none"> • Contropiastra inclusa • Strike plate included • Schließblech im Set enthalten 							
E. 274		V-604 WC-LE	1 pc	NS	289,30 /pc	CP	280,00 /pc		
		<ul style="list-style-type: none"> • Contropiastra inclusa • Strike plate included • Schließblech im Set enthalten 							
E. 275		V-604 CH-CH	1 pc	NS	233,30 /pc	CP	224,00 /pc		
E. 276		V-604 2FLG	1 pc	NS	335,50 /pc	CP	326,50 /pc		
		<ul style="list-style-type: none"> • Serratura non inclusa • Lock not included • Schloss nicht enthalten 							

POS.	PROD.	ART.	Q.TÀ	FIN.	EURO	FIN.	EURO	FIN.	EURO
V-407		▶ INDOOR 117							
E. 277		V-407 LE-LE	1 pc	NS	295,00 /pc	CP	285,30 /pc		
E. 278		V-407 LE-PO	1 pc	NS	295,00 /pc	CP	285,30 /pc		
E. 279		V-407 CH-LE	1 pc	NS	255,50 /pc	CP	245,70 /pc		
E. 280		V-407-604-SP12	1 pc		27,30 /pc				
E. 281		V-407 CH-PO	1 pc	NS	255,50 /pc	CP	245,70 /pc		
E. 282		V-407 PO-PO	1 pc	NS	295,00 /pc	CP	285,30 /pc		
E. 283		V-407 CH-WC	1 pc	NS	235,00 /pc	CP	225,30 /pc		
<ul style="list-style-type: none"> • Contropiastra inclusa • Strike plate included • Schließblech im Set enthalten 									
E. 284		V-407 WC-PO	1 pc	NS	270,30 /pc	CP	262,00 /pc		
<ul style="list-style-type: none"> • Contropiastra inclusa • Strike plate included • Schließblech im Set enthalten 									

POS.	PROD.	ART.	Q.TÀ	FIN.	EURO	FIN.	EURO	FIN.	EURO
E. 285		V-407 WC-LE • Contropiastra inclusa • Strike plate included • Schließblech im Set enthalten	1 pc	NS	270,30 /pc	CP	262,00 /pc		
E. 286		V-407 CH-CH	1 pc	NS	217,00 /pc	CP	207,50 /pc		
E. 287		V-407 2FLG • Serratura non inclusa • Lock not included • Schloss nicht enthalten	1 pc	NS	326,50 /pc	CP	318,00 /pc		

CONTROPIASTRE
STRIKE PLATES / SCHLIEßBLECHE ▶ INDOOR 138







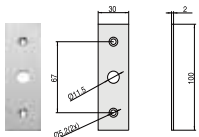
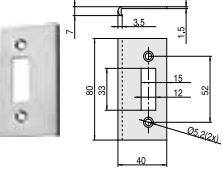
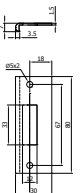
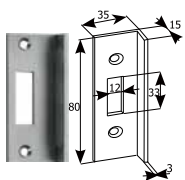
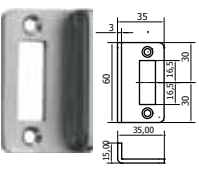
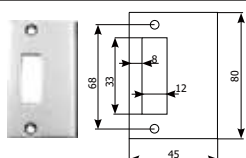
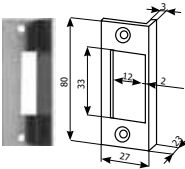
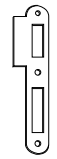
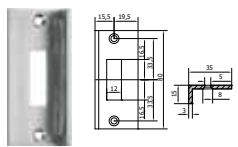

- Prezzi speciali per l'acquisto delle quantità minime indicate (CF) dell'articolo.
NB eventuali riordini o aggiunte per completamenti se di quantità inferiore alla minima, saranno fatturati al prezzo normale
- Special prices for the purchase of the minimum quantities indicated (CF) of the article.
Note Well: any reorders or additions for completions of quantity less than the minimum will be invoiced at the normal price.
- Artikel mit Sonderpreisen bei Mindestabnahmemengen sind mit (CF) gekennzeichnet.
Nachbestellungen oder Ergänzungen unter der Mindestabnahmemenge werden mit dem Normalpreis verrechnet.

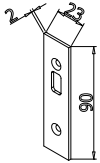
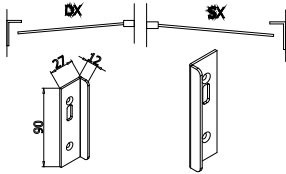
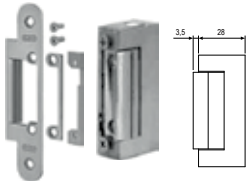
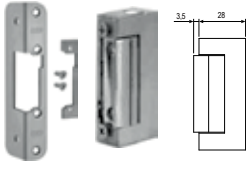
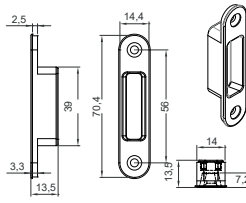
E. 288		CP-015	1 pc		38,50 /pc				
		CP-015 M	1 pc		48,30 /pc				
E. 289		V-037 • Per serrature / For locks: V-900 / V-540 / V-230 / V-730 V-200 / V-720 / V-400	1 pc	CP	11,30 /pc				
		V-037	■ min 10 pcs	CP	6,30 /pc				
E. 290		CP-01 • Per serrature / For locks: V-900 / V-540 / V-230 UV V-730 UV / V-200 UV / V-720 UV V-400 UV / V-750 / V-780	1 pc	CP	14,70 /pc				
		CP-01	■ min 10 pcs	CP	10,70 /pc				
E. 291		V-022 • Per serrature / For locks: V-724 / V-744 / V-734 V-504 NC / V-518 / V-554 NC	1 pc	CS	18,50 /pc	NS	18,50 /pc	CR	36,70 /pc
E. 292		V-002 • Per serrature / For locks: V-900 / V-540 / V-230 / V-730 V-200 / V-720 / V-400 / V-726 V-746 / V-736 / V-515 / V-520 V-555	1 pc	CR	18,70 /pc				

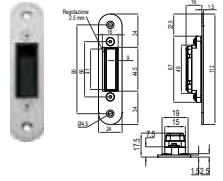
- Confezioni industriali
- Industrial packaging
- Industrieverpackungen

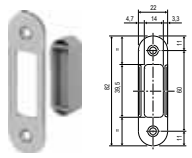
- **min**
- Prezzi speciali per l'acquisto delle quantità minime indicate dell'articolo.
NB eventuali riordini o aggiunte per completamenti se di quantità inferiore alla minima, saranno fatturati al prezzo normale
- Special prices for the purchase of the minimum quantities indicated of the article.
Note Well: any reorders or additions for completions of quantity less than the minimum will be invoiced at the normal price.
- Artikel mit Sonderpreisen bei Mindestabnahmemengen sind mit gekennzeichnet.
Nachbestellungen oder Ergänzungen unter der Mindestabnahmemenge werden mit dem Normalpreis verrechnet.

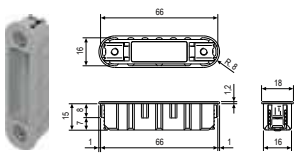
POS.	PROD.	ART.	Q.TÀ	FIN.	EURO	FIN.	EURO	FIN.	EURO
E. 293		V-023 • Per serrature / For locks: V-725 / V-745 / V-735 / V-505 V-519 / V-557	1 pc	CS	32,00 /pc	NS	36,70 /pc	CR	36,70 /pc
E. 294		V-020 • Per serrature / For locks: V-900 / V-540 / V-230 / V-730 V-200 / V-720 / V-400 / V-750	1 pc	CS	32,00 /pc	NS	36,70 /pc	CR	36,70 /pc
E. 295									
E. 296		V-021 • Per serrature / For locks: V-900 / V-540 / V-230 / V-730 V-200 / V-720 / V-400	1 pc	CS	32,00 /pc	NS	36,70 /pc	CR	36,70 /pc
E. 297		V-031 • Per serrature / For locks: V-900 / V-540 / V-230 / V-730 V-200 / V-720 / V-400	1 pc	AN	32,00 /pc				
E. 298		V-931 • Per serrature / For locks: V-900 / V-540 / V-230 / V-730 V-200 / V-720 / V-400	1 pc	AN	37,00 /pc	NS	41,30 /pc		
		V-931	■ min 20 pcs	AN	26,50 /pc	NS	30,30 /pc		
E. 299		V-032 • Per serrature / For locks: V-900 / V-540 / V-230 / V-730 V-200 / V-720 / V-400	1 pc	CS	32,00 /pc	CR	36,70 /pc		
E. 300		V-033 • Per serrature / For locks: V-900 / V-540 / V-230 / V-730 V-200 / V-720 / V-400	1 pc	IX	36,70 /pc				
E. 301		CP-02 L CP-02 R	1 pc		20,30 /pc				
E. 302		CP-04	1 pc	AN	56,50 /pc				

POS.	PROD.	ART.	Q.TÀ	FIN.	EURO	FIN.	EURO	FIN.	EURO
E. 303	 V-568 • Per serrature / For locks: V-564 / V-565 / V-584 / V-585 V-594 / V-574 / V-575		1 pc	IX	15,50 /pc				
E. 304	 V-567-DX V-567-SX • Per serrature / For locks: V-564 / V-565 / V-584 / V-585 V-594 / V-574 / V-575		1 pc	AN	23,00 /pc				
E. 305	 CP-05		1 pc	AN	311,50 /pc				
E. 306	 CP-06		1 pc	AN	311,50 /pc				
E. 307	 CP-010 		1 pc	AN	22,30 /pc				
E. 308	 CP-011 		1 pc	AN	28,30 /pc				
E. 309	 CP-012 		1 pc	CP	34,30 /pc				
E. 310	 CP-013 		1 pc	CP	44,30 /pc				

POS.	PROD.	ART.	Q.TÀ	FIN.	EURO	FIN.	EURO	FIN.	EURO	
CILINDRI CYLINDERS ZYLINDER ▶ INDOOR 142										
E. 311		C-01		1 pc	CS	57,00 /pc	NS	57,00 /pc	CR	57,00 /pc
					OL	57,00 /pc				
E. 312		C-02		1 pc	CS	57,00 /pc	NS	57,00 /pc	CR	57,00 /pc
					OL	57,00 /pc				
E. 313		C-03		1 pc	CS	80,70 /pc	NS	80,70 /pc	CR	80,70 /pc
					OL	80,70 /pc				
E. 314		C-04		1 pc	CR	37,30 /pc				
E. 315		C-05		1 pc	CS	55,30 /pc	NS	55,30 /pc	CR	55,30 /pc
E. 316		C-06		1 pc	CR	29,70 /pc				
E. 317		C-07		1 pc	CS	92,00 /pc	NS	92,00 /pc	CR	92,00 /pc
					OL	92,00 /pc				
E. 318		C-08		1 pc	CS	57,70 /pc	NS	57,70 /pc	CR	57,70 /pc
					OL	57,70 /pc	CP	57,70 /pc		
E. 319		C-08-Q		1 pc	CS	49,30 /pc	NS	49,30 /pc	CR	49,30 /pc
					CP	49,30 /pc				
E. 320		C-09		1 pc	CR	43,30 /pc				
E. 321		C-013		1 pc	CS	47,00 /pc	NS	47,00 /pc	CR	47,00 /pc
					CP	47,00 /pc				
E. 322		C-014		1 pc	CR	32,00 /pc				

POS.	PROD.	ART.	Q.TÀ	FIN.	EURO	FIN.	EURO	FIN.	EURO
E. 323		C-016	1 pc	CS	76,70 /pc	NS	76,70 /pc	CR	76,70 /pc
				CP	76,70 /pc				
E. 324		C-018	1 pc	CS	46,00 /pc	NS	46,00 /pc	CR	46,00 /pc
				CP	46,00 /pc				
E. 325		C-023	1 pc	CR	47,70 /pc				
E. 326		C-024	1 pc	CR	47,70 /pc				
E. 327		C-010	1 pc	CR	28,00 /pc				
E. 328		C-011	1 pc	NS	57,00 /pc	CR	64,50 /pc	CP	62,00 /pc
E. 329		C-012	1 pc	NS	63,30 /pc	CR	70,70 /pc	CP	68,30 /pc
E. 330		C-019	1 pc	NS	63,30 /pc	CR	70,70 /pc	CP	68,30 /pc
E. 331		C-020	1 pc	CR	28,00 /pc				
E. 332		C-021	1 pc	NS	57,00 /pc	CR	64,50 /pc	CP	62,00 /pc
E. 333		C-025	1 pc	CR	28,00 /pc				
E. 334		C-022	1 pc	NS	155,00 /pc				
E. 335		EX-STESSA-CH	1 pc		47,00 /pc				

- Extra fornitura cilindri con stessa chiave (KA), disponibile per cilindri C-04 | C-06. Costo extra per ogni cilindro.
- Extra keyed alike cylinders (KA) available for art. C-04 | C-06. Price extra for each cylinder
- Aufpreis gleichschlüssel (KA) Lieferbare für Art. C-04 | C-06. Aufpreis je Zylinder

- Confezioni industriali
- Industrial packaging
- Industrieverpackungen

min

- Prezzi speciali per l'acquisto delle quantità minime indicate dell'articolo. NB eventuali riordini o aggiunte per completamenti se di quantità inferiore alla minima, saranno fatturati al prezzo normale
- Special prices for the purchase of the minimum quantities indicated of the article. Note Well: any reorders or additions for completions of quantity less than the minimum will be invoiced at the normal price.
- Artikel mit Sonderpreisen bei Mindestabnahmemengen sind mit gekennzeichnet. Nachbestellungen oder Ergänzungen unter der Mindestabnahmemenge werden mit dem Normalpreis verrechnet.





POS.	PROD.	ART.	Q.TÀ	FIN.	EURO	FIN.	EURO	FIN.	EURO
ACCESSORI PER PORTE <i>ACCESSORIES FOR DOORS ZUBEHÖRE</i> ▶ INDOOR 146									
E. 336		V-003-08 V-003-10	1 pc	CS	80,30 /pc	NS	84,30 /pc	CR	87,70 /pc
				OL	101,30 /pc	CP	80,30 /pc		
E. 337		V-004	1 pc	CS	35,00 /pc				
E. 338		V-003-2FLG-08 V-003-2FLG-10	1 pc	CS	80,30 /pc	NS	84,30 /pc	CR	87,70 /pc
				OL	101,30 /pc	CP	80,30 /pc		
E. 339		V-001	1 pc		9,70 /pc				
E. 339.1		V-001 B	1 pc		13,30 /pc				
		V-001 B	■ min 10 pcs		8,30 /pc				
E. 340		P-F07	1 pc		9,70 /pc				
E. 341		P-F01	1 pc		21,00 /pc				

POS.	PROD.	ART.	Q.TÀ	FIN.	EURO	FIN.	EURO	FIN.	EURO
E. 342		P-F06	1 pc		16,30 /pc				
E. 343		P-F02	1 pc		9,70 /pc				
E. 344		P-F04	1 pc		13,50 /pc				
E. 345		P-F03	1 pc		13,50 /pc				
E. 346		01999	1 pc	IX	25,50 /pc				
E. 347		02002	1 pc	CS	62,00 /pc				
E. 348		L-112	1 pc	CS	34,70 /pc				
E. 349		L-111	1 pc	CS	48,30 /pc				
E. 350		V-025	1 pc	CS	47,00 /pc				
E. 351		V-026	1 pc	CS	47,00 /pc				
E. 352		V-027	1 pc	CS	39,70 /pc				

- Confezioni industriali
- Industrial packaging
- Industrieverpackungen

min

- Prezzi speciali per l'acquisto delle quantità minime indicate dell'articolo.
NB eventuali riordini o aggiunte per completamenti se di quantità inferiore alla minima, saranno fatturati al prezzo normale
- Special prices for the purchase of the minimum quantities indicated of the article.
Note Well: any reorders or additions for completions of quantity less than the minimum will be invoiced at the normal price.
- Artikel mit Sonderpreisen bei Mindestabnahmemengen sind mit gekennzeichnet.
Nachbestellungen oder Ergänzungen unter der Mindestabnahmemenge werden mit dem Normalpreis verrechnet.

POS.	PROD.	ART.	Q.TÀ	FIN.	EURO	FIN.	EURO	FIN.	EURO
E. 353		V-028	1 pc	CS	39,70 /pc				
E. 354		V-029	1 pc	CS	85,00 /pc				
ACCESSORI PER VETRINE <i>ACCESSORIES FOR DISPLAY CABINETS ZUBEHÖRE FÜR SCHAUFENSTERAUSLAG</i> ▶ INDOOR 148									
E. 354.1		B-309 DX+SX	1 pair		38,50 /pair				
		B-309 DX+SX	■ min 10 pairs		32,50 /pair				
CERNIERE VERTICALI <i>VERTICAL HINGES 3-TEILIGE BÄNDER</i> ▶ INDOOR 120									
E. 355		V-709	1 pc	AN	75,00 /pc	CS	78,00 /pc	NS	80,30 /pc
				CR	86,30 /pc	CP	81,70 /pc	NO	97,30 /pc
		V-709	■ min 10 pcs	AN	63,30 /pc	CS	65,30 /pc	NS	67,50 /pc
				CR	72,30 /pc	CP	68,50 /pc	NO	- /pc
		V-709	■ min 50 pcs	AN	53,70 /pc	CS	55,30 /pc	NS	57,00 /pc
				CR	62,00 /pc	CP	57,00 /pc	NO	- /pc
E. 356		V-509	1 pc	AN	63,30 /pc	CS	70,00 /pc	NS	67,50 /pc
				CR	75,00 /pc	CP	70,70 /pc	NO	108,00 /pc
				OL	/pc				
		V-509	■ min 10 pcs	AN	55,30 /pc	CS	63,70 /pc	NS	59,00 /pc
				CR	64,70 /pc	CP	62,70 /pc	NO	- /pc
		V-509	■ min 50 pcs	AN	49,00 /pc	CS	57,70 /pc	NS	53,00 /pc
CR	56,50 /pc			CP	56,30 /pc	NO	- /pc		
E. 357		V-809	1 pc	AN	59,50 /pc	NS	62,70 /pc	CR	66,30 /pc
				CP	62,70 /pc				
		V-809	■ min 10 pcs	AN	50,00 /pc	NS	51,00 /pc	CR	60,00 /pc
				CP	51,00 /pc				
		V-809	■ min 50 pcs	AN	44,00 /pc	NS	47,30 /pc	CR	50,70 /pc
				CP	47,30 /pc				

POS.	PROD.	ART.	Q.TÀ	FIN.	EURO	FIN.	EURO	FIN.	EURO
E. 358		V-402	1 pc	AN	58,30 /pc	IXE°	59,50 /pc	CS	60,00 /pc
				CR	66,30 /pc	CP	59,50 /pc	OL	115,00 /pc
				NO	81,70 /pc				
		V-402	■ min 10 pcs	AN	43,30 /pc	IXE°	44,30 /pc	CS	46,00 /pc
				CR	54,30 /pc	CP	44,30 /pc	OL	109,00 /pc
				NO	77,70 /pc				
		V-402	■ min 50 pcs	AN	37,30 /pc	IXE°	38,50 /pc	CS	40,00 /pc
				CR	48,30 /pc	CP	38,50 /pc	OL	103,00 /pc
				NO	73,50 /pc				
°Finitura abbinabile a: NS - IX °Finish matchable with: NS - IX °Passende Oberfläche: NS - IX									
E. 359		V-701	1 pc	AN	79,30 /pc	CS	80,30 /pc	NS	83,00 /pc
				CR	88,70 /pc	CP	84,30 /pc	NO	88,70 /pc
		V-701	■ min 10 pcs	AN	66,30 /pc	CS	68,30 /pc	NS	69,30 /pc
				CR	73,50 /pc	CP	70,30 /pc	NO	73,50 /pc
		V-701	■ min 50 pcs	AN	55,70 /pc	CS	57,00 /pc	NS	59,50 /pc
				CR	64,30 /pc	CP	59,50 /pc	NO	64,30 /pc
E. 360		V-704 DX/SX	1 pc	AN	91,30 /pc	CS	98,30 /pc	NS	100,70 /pc
				CR	106,50 /pc	CP	102,00 /pc	NO	106,50 /pc
		V-704 DX/SX	■ min 10 pcs	AN	76,70 /pc	CS	81,70 /pc	NS	84,30 /pc
				CR	88,70 /pc	CP	85,30 /pc	NO	87,30 /pc
		V-704 DX/SX	■ min 40 pcs	AN	67,00 /pc	CS	70,70 /pc	NS	73,30 /pc
				CR	78,00 /pc	CP	73,30 /pc	NO	78,00 /pc
E. 361		V-703							
<ul style="list-style-type: none"> • inclusi • included • enthalten 									
E. 362		V-909	1 pc	AN	49,00 /pc	IXE	53,50 /pc	NO	60,00 /pc
		V-909	■ min 10 pcs	AN	35,30 /pc	IXE	41,30 /pc	NO	48,30 /pc
		V-909	■ min 50 pcs	AN	28,00 /pc	IXE	33,00 /pc	NO	38,50 /pc
E. 363		V-909-A	1 pc	AN	23,50 /pc	IX	25,30 /pc		
		V-909-A	■ min 10 pcs	AN	13,50 /pc	IX	15,50 /pc		
		V-909-A	■ min 50 pcs	AN	9,00 /pc	IX	10,70 /pc		

- Confezioni industriali
- Industrial packaging
- Industrieverpackungen

■ min

- Prezzi speciali per l'acquisto delle quantità minime indicate dell'articolo.
NB eventuali riordini o aggiunte per completamenti se di quantità inferiore alla minima, saranno fatturati al prezzo normale
- Special prices for the purchase of the minimum quantities indicated of the article.
Note Well: any reorders or additions for completions of quantity less than the minimum will be invoiced at the normal price.
- Artikel mit Sonderpreisen bei Mindestabnahmemengen sind mit gekennzeichnet.
Nachbestellungen oder Ergänzungen unter der Mindestabnahmemenge werden mit dem Normalpreis verrechnet.

POS.	PROD.	ART.	Q.TÀ	FIN.	EURO	FIN.	EURO	FIN.	EURO
E. 364		V-729	1 pc	AN	61,50 /pc	NS	61,50 /pc	CR	68,50 /pc
		V-729	■ min 10 pcs	AN	51,70 /pc	NS	51,70 /pc	CR	57,70 /pc
E. 365		V-739	1 pc	AN	71,50 /pc	NS	71,50 /pc	CR	80,30 /pc
		V-739	■ min 10 pcs	AN	62,70 /pc	NS	62,70 /pc	CR	70,70 /pc
E. 366		V-702	1 pc	CS	98,30 /pc	NS	101,50 /pc	CR	110,30 /pc
				CP	98,30 /pc				
E. 367		V-409	1 pc	CS	113,00 /pc	NS	115,70 /pc	CR	125,00 /pc
				CP	113,00 /pc				
E. 368		V-719	1 pc	CS	123,70 /pc	NS	129,70 /pc	CR	139,00 /pc
E. 369		V-513	1 pc	CS	140,30 /pc	NS	148,50 /pc	CR	162,50 /pc
				OL	162,50 /pc	CP	136,30 /pc		
E. 370		V-707 DX V-707 SX	1 pc	CS	102,30 /pc	NS	105,30 /pc	CR	114,50 /pc
				CP	102,30 /pc				
DISPONIBILE FINO AD ESAURIMENTO SCORTE AVAILABLE WHILE STOCKS LAST LIEFERBAR SOLANGE DER VORRAT REICHT									
E. 371		V-705	2 pc		69,70 /set				
E. 372		V-706	2 pc		69,70 /set				
E. 373		V-107	1 pc	CS	80,00 /pc	NS	83,00 /pc	CR	90,50 /pc
				CP	80,30 /pc	OL	90,50 /pc		
DISPONIBILE FINO AD ESAURIMENTO SCORTE AVAILABLE WHILE STOCKS LAST LIEFERBAR SOLANGE DER VORRAT REICHT									

POS.	PROD.	ART.	Q.TÀ	FIN.	EURO	FIN.	EURO	FIN.	EURO
E. 374		V-105	1 pc		69,70 /pc				
E. 375		V-106	1 pc		69,70 /pc				
CERNIERE TUTT'ALTEZZA HINGE PROFILE - BANDPROFIL ▶ INDOOR 124									
E. 376	 SX DX L=2400 INCLUDED	P-08	1 pc	AN	217,30 /pc				
		P-08	■ min 5 pcs	AN	182,00 /pc				
E. 377		P-08-COLLA	1 pc		112,00 /pc				
E. 378		P-08-PIST	1 pc		92,00 /pc				
E. 379	 SX DX L=2400 INCLUDED	P-09	1 pc	AN	441,70 /pc				
		P-09	■ min 5 pcs	AN	394,00 /pc				

- Confezioni industriali
- Industrial packaging
- Industrieverpackungen

- **min**
- Prezzi speciali per l'acquisto delle quantità minime indicate dell'articolo.
NB eventuali riordini o aggiunte per completamenti se di quantità inferiore alla minima, saranno fatturati al prezzo normale
- Special prices for the purchase of the minimum quantities indicated of the article.
Note Well: any reorders or additions for completions of quantity less than the minimum will be invoiced at the normal price.
- Artikel mit Sonderpreisen bei Mindestabnahmemengen sind mit gekennzeichnet.
Nachbestellungen oder Ergänzungen unter der Mindestabnahmemenge werden mit dem Normalpreis verrechnet.







POS.	PROD.	ART.	Q.TÀ	FIN.	EURO	FIN.	EURO	FIN.	EURO
CERNIERE ORIZZONTALI									
<i>HORIZONTAL HINGES - 2-TEILIGE BÄNDER</i>									
► INDOOR 126									
E. 380		V-202	1 pc	AN	68,30 /pc	IXE°	69,50 /pc	CS	72,00 /pc
		V-202	1 pc	CR	84,30 /pc	CP	72,00 /pc	OL	125,70 /pc
		V-202	■ min 10 pcs	AN	56,50 /pc	IXE°	58,00 /pc	CS	60,30 /pc
		V-202	■ min 10 pcs	CR	72,30 /pc	CP	60,30 /pc		-
		V-202	■ min 50 pcs	AN	52,30 /pc	IXE°	53,50 /pc	CS	55,70 /pc
		V-202	■ min 50 pcs	CR	67,50 /pc	CP	55,70 /pc		-
°Finitura abbinabile a: NS - IX °Finish matchable with: NS - IX °Passende Oberfläche: NS - IX									
E. 381		V-201	1 pc	AN	54,30 /pc	IXE°	55,70 /pc	CS	57,70 /pc
		V-201	1 pc	CR	108,00 /pc	CP	57,70 /pc	OL	108,00 /pc
		V-201	■ min 10 pcs	AN	44,30 /pc	IXE°	46,00 /pc		- -
		V-201	■ min 10 pcs	CR	102,00 /pc		- -	OL	102,00 /pc
		V-201	■ min 50 pcs	AN	38,50 /pc	IXE°	40,00 /pc		- -
		V-201	■ min 50 pcs	CR	96,00 /pc		- -	OL	96,00 /pc
°Finitura abbinabile a: NS - IX °Finish matchable with: NS - IX °Passende Oberfläche: NS - IX									
E. 382		V-401	1 pc	AN	55,30 /pc	IXE°	57,70 /pc	CS	59,00 /pc
		V-401	1 pc	CR	110,00 /pc	CP	59,00 /pc	OL	110,00 /pc
		V-401	■ min 10 pcs	AN	46,00 /pc	IXE°	48,30 /pc	CS	- -
		V-401	■ min 10 pcs	CR	104,00 /pc		- -	OL	104,00 /pc
		V-401	■ min 50 pcs	AN	40,00 /pc	IXE°	42,30 /pc		- -
		V-401	■ min 50 pcs	CR	98,30 /pc		- -	OL	98,30 /pc
E. 383		V-102	1 pc	CS	102,00 /pc	NS	102,00 /pc	CR	110,00 /pc
		V-102	1 pc	OL	110,00 /pc				
		V-102	■ min 10 pcs	CS	96,00 /pc	NS	96,00 /pc	CR	103,00 /pc
		V-102	■ min 10 pcs	OL	103,00 /pc				
E. 384		V-403	1 pc	AN	79,30 /pc	NS	83,00 /pc	CS	106,50 /pc
		V-403	1 pc	CR	129,50 /pc	OL	129,50 /pc	CP	104,70 /pc
		V-403	■ min 10 pcs	AN	69,70 /pc	NS	73,30 /pc		- -
		V-403	■ min 10 pcs		- -		- -		- -
		V-403	■ min 50 pcs	AN	64,70 /pc	NS	66,30 /pc		- -
		V-403	■ min 50 pcs		- -		- -		- -

POS.	PROD.	ART.	Q.TÀ	FIN.	EURO	FIN.	EURO	FIN.	EURO
CERNIERE AUTOMATICHE									
<i>AUTOMATIC HINGES - AUTOMATISCHE BÄNDER</i>									
▶ INDOOR 128									
E. 385		V-908	1 pc	NS	194,30 /pc	CR	196,50 /pc	CP	194,30 /pc
		V-908	■ min 10 pcs	NS	188,30 /pc	CR	190,50 /pc	CP	188,30 /pc
		V-908	■ min 40 pcs	NS	185,00 /pc	CR	186,30 /pc	CP	185,00 /pc
E. 386		V-508	1 pc	CS	249,30 /pc	NS	249,30 /pc	CR	252,70 /pc
		V-508	■ min 10 pcs	CS	235,50 /pc	NS	235,50 /pc	CR	239,00 /pc
		V-508	■ min 10 pcs	OL	270,00 /pc	CP	249,30 /pc		
E. 387		V-516	1 pc	CS	413,30 /pc	NS	413,30 /pc	CR	424,70 /pc
		V-516	■ min 10 pcs	CS	392,30 /pc	NS	392,30 /pc	CR	404,00 /pc
		V-516	■ min 10 pcs	OL	441,70 /pc	CP	413,30 /pc		
E. 388		V-508-AS	1 pc	NS	253,70 /pc				
		V-508-AS	■ min 10 pcs	NS	240,00 /pc				
E. 389		V-908-AS	1 pc	NS	232,30 /pc	CR	234,30 /pc	CP	232,30 /pc
		V-908-AS	■ min 10 pcs	NS	223,70 /pc	CR	226,00 /pc	CP	223,70 /pc
E. 390		V-507 A-B	1 pc	CS	265,00 /pc	NS	265,00 /pc	CR	292,00 /pc
E. 391		V-018	1 pc	AN	76,00 /pc				

- Confezioni industriali
- Industrial packaging
- Industrieverpackungen

■ **min**

- Prezzi speciali per l'acquisto delle quantità minime indicate dell'articolo. NB eventuali riordini o aggiunte per completamenti se di quantità inferiore alla minima, saranno fatturati al prezzo normale
- Special prices for the purchase of the minimum quantities indicated of the article. Note Well: any reorders or additions for completions of quantity less than the minimum will be invoiced at the normal price.
- Artikel mit Sonderpreisen bei Mindestabnahmemengen sind mit gekennzeichnet. Nachbestellungen oder Ergänzungen unter der Mindestabnahmemenge werden mit dem Normalpreis verrechnet.

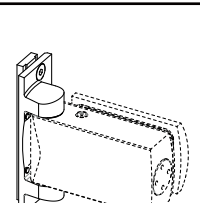
POS.	PROD.	ART.	Q.TÀ	FIN.	EURO	FIN.	EURO	FIN.	EURO
CERNIERE OLEODINAMICHE HYDRAULIC HINGES - HYDRAULISCHE BÄNDER ▶ INDOOR 130									
E. 392		V-808	1 pc	AN	319,30 /pc	NS	336,50 /pc	CR	319,30 /pc
E. 393		V-808-AS	1 pc	AN	319,30 /pc	NS	336,50 /pc	CR	319,30 /pc
E. 394		V-816	1 pc	AN	422,30 /pc	NS	468,00 /pc	CR	422,30 /pc
E. 395		V-808-R	1 pc	IX	394,70 /pc	IL	407,30 /pc		
E. 396		V-816-R	1 pc	IX	518,50 /pc	IL	526,50 /pc		
E. 397		V-807	1 pc	AN	337,50 /pc	NS	361,50 /pc	CR	337,50 /pc
E. 398		P-066	1 pc	AN	62,00 /pc				
<ul style="list-style-type: none"> • Cerniera V-807 non inclusa • Hinge V-807 not included • Band V-807 nicht enthalten 									



GUIDA TECNICA PER LA SCELTA DEL VOSTRO SISTEMA
TECHNICAL GUIDE FOR THE CHOICE OF YOUR SYSTEM
AUSWAHL VON DUSCHKABINEN NACH VORHANDENEN KRITERIEN

**MANIGLIE
DOORHANDLES
TÜRGRIFFE**





- V-1711
Morphos**
▶ 400 
- V-1651
Dune**
▶ 400 
- V-1611
Blade**
▶ 400 
- V-1731
Elektra**
▶ 400 
- V-1721
Preso**
▶ 400 
- V-1762
Raatio**
▶ 400 
- V-1671
Le Mans**
▶ 400 
- V-921
Elga Due**
▶ 401 
- V-1801
Tecno**
▶ 402 
- V-1712
Morphos Light**
▶ 401 
- V-910**
▶ 401 
- V-1761
Casto**
▶ 401 
- V-1681
Vola**
▶ 402 
- V-1601
Cubus**
▶ 401 















- V-1781
Dali**
▶ 401 
- V-1691
Go-Go**
▶ 402 
- V-140
Daytona**
▶ 402 
- V-101
L-Form 90**
▶ 401 
- V-110-Inox
U-Form**
▶ 402 
- V-1751
Sole**
▶ 402 
- V-141
Capri**
▶ 403 
- V-111
Milano**
▶ 402 
- V-1391
Vitrea color**
▶ 403 
- V-121
Sabbia**
▶ 403 
- V-1771
Amleto**
▶ 403 
- V-1791
Wind**
▶ 403 

**MANIGLIONI AD INCOLLAGGIO
PULLHANDLES WITH SELF-ADHESIVE
STOSSGRIFFE SELBSTKLEBEND**

- SQUARE 10**
▶ 405 
- POR-0400 V**
▶ 406 
- POR-0408 V**
▶ 406 

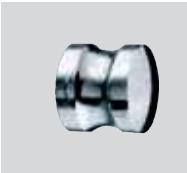
**MANIGLIONI MINI
PULLHANDLES MINI
MINI STOSSGRIFFE**





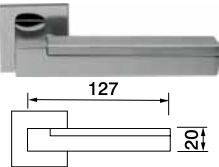
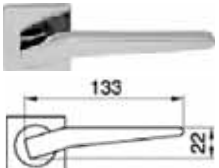
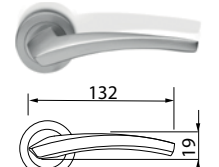
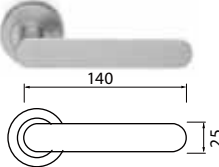
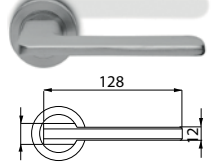
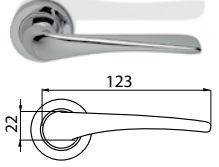
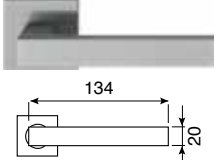

- Square 10**
▶ 407 
- Square Alu Ø 14**
▶ 408 
- Round Mini Ø 16**
▶ 410 
- Square Mini Ø 15**
▶ 409 

MANIGLIONI PULLHANDLES STOSSGRIFFE	MANIGLIONI CON SERRATURA DUOLOCK PULLHANDLES WITH LOCK DUOLOCK VERSPERBARER STOSSGRIFFE DUOLOCK	NICCHIE PER SCORREVOLI SLIDING HANDLES GRIFFMUSCHELN
<p>Round 02 Ø 20-25-30 ▶ 411</p> 	<p>DUOLOCK L=1500 mm ▶ 419</p> 	<ul style="list-style-type: none"> • NICCHIE • SLIDING HANDLES • GRIFFMUSCHELN <p>▶ 423</p> 
<p>Square 41 ∅ 19-25-40 ▶ 413</p> 	<p>DUOLOCK H L=2200 mm ▶ 420</p> 	
<p>Square 40 ∅ 25 ▶ 413</p> 		
<p>Round 10 Ø 20-25-30 ▶ 412</p> 		
<p>Round 01 Ø 20-25-30 ▶ 414</p> 	<p>MANIGLIONI ANTIPANICO PANIC EXIT DEVICES PANIK STOSSGRIFFE</p>	<p>POMOLI KNOBS KNÖPFE</p>
<p>Round 11 Ø 25 ▶ 415</p> 	<p>A-100 ▶ 421</p> 	<ul style="list-style-type: none"> • POMOLI • KNOBS • KNÖPFE <p>▶ 426</p> 
<p>Round 03 Ø 25-30 ▶ 415</p> 		
<p>Round 08 Ø 32 ▶ 415</p> 		
<p>Round 09 Ø 32 ▶ 416</p> 		

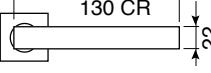
POS.	PROD.	ART.	Q.TÀ	FIN.	EURO	FIN.	EURO	FIN.	EURO
<p>MANIGLIE DOORHANDLES / TÜRGRIFFE</p> <p style="text-align: right;">▶ INDOOR 154</p>									
<p>• Paio maniglie per serrature vetro (serratura esclusa) - Rosette per porte in legno optional non incluse • Pair handles for Glasslocks (Lock not included) - Rosette for wooden doors optional not included • Paar Türgriffe für Glastürschlösser (Schloss nicht enthalten) - Rosette für Holztüren optional nicht enthalten</p>									
F.1		V-1711 MORPHOS	1 pair	CR/CS	160,00 /pair	NS/NL	160,00 /pair		
F.2		V-1721 PRESO	1 pair	CS	129,70 /pair	NS	129,70 /pair	CR	129,70 /pair
				OL	129,70 /pair				
F.3		V-1651 DUNE	1 pair	CS	122,00 /pair	NS	122,00 /pair	CR	122,00 /pair
				OL	122,00 /pair				
F.4		V-1762 RATIO	1 pair	CS	144,30 /pair	NS	148,30 /pair	CR	144,30 /pair
F.5		V-1611 BLADE	1 pair	CS	122,00 /pair	NS	122,00 /pair	CR	122,00 /pair
				OL	122,00 /pair				
F.6		V-1671 LE MANS	1 pair	CS	122,00 /pair	NS	122,00 /pair	CR	122,00 /pair
				OL	122,00 /pair				
F.7		V-1731 ELEKTRA	1 pair	CR	60,00 /pair	OL	97,00 /pair	CP	71,50 /pair
				AN	54,30 /pair	NS	74,30 /pair	CS	71,50 /pair
		V-1731 ELEKTRA	■ min 10 pairs	AN	44,00 /pair	NS	54,70 /pair		

■ Confezioni industriali
 ■ Industrial packaging
 ■ Industrieverpackungen

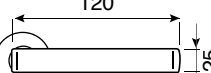
■ **min**
 • Prezzi speciali per l'acquisto delle quantità minime indicate dell'articolo
 NB eventuali riordini o aggiunte per completamenti se di quantità inferiore alla minima, saranno fatturati al prezzo normale
 • Special prices for the purchase of the minimum quantities indicated of the article
 Note Well: any reorders or additions for completions of quantity less than the minimum will be invoiced at the normal price
 • Artikel mit Sonderpreisen bei Mindestabnahmemengen sind mit gekennzeichnet
 Nachbestellungen oder Ergänzungen unter der Mindestabnahmemenge werden mit dem Normalpreis verrechnet



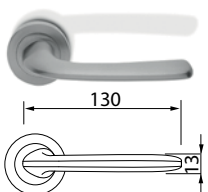
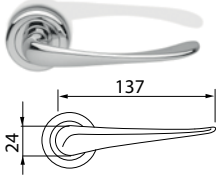
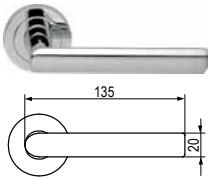
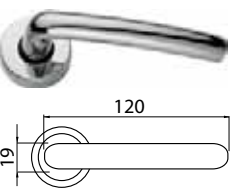
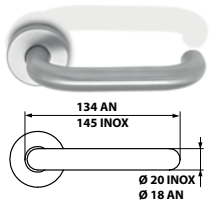
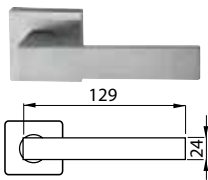
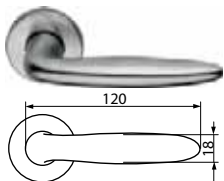

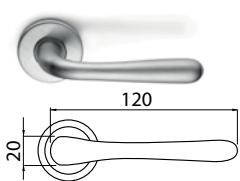
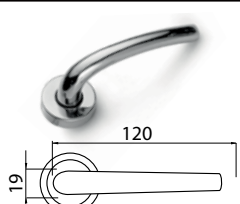
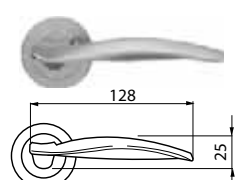
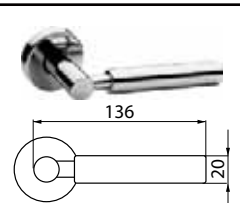
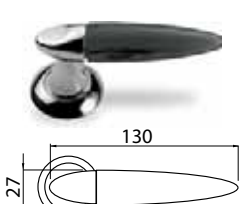

POS.	PROD.	ART.	Q.TÀ	FIN.	EURO	FIN.	EURO	FIN.	EURO
F. 8	 120 130 CR 22	V-921 ELGA DUE	1 pair	CS	48,30 /pair	NS	48,30 /pair	CP	48,30 /pair
				CR	56,50 /pair	NO	48,30 /pair		
	 22	V-921 ELGA DUE	■ min 10 pairs	CS	44,00 /pair	NS	44,00 /pair	CP	44,00 /pair
				CR	50,30 /pair	NO	44,00 /pair		
F. 9	 135 20	V-101 L-FORM 90°	1 pair	IX	35,00 /pair	AN	35,00 /pair		
		V-101 L-FORM 90°	■ min 10 pairs	IX	32,30 /pair	AN	32,30 /pair		
F. 10	 127 20	V-1712 MORPHOS LIGHT	1 pair	CS	160,00 /pair	NS	163,00 /pair	CR	160,00 /pair
F. 11	 130 22	V-1601 CUBUS	1 pair	CS	125,00 /pair	NS	125,00 /pair	CR	125,00 /pair
F. 12	 120 25 FINE SERIE END OF SERIES AUSLAUFMODELL	V-910	1 pair	CS	56,50 /pair	NS	56,50 /pair	CR	56,50 /pair
				CP	56,50 /pair	GR	50,70 /pair		
	 25	V-910	■ min 10 pairs	CS	47,70 /pair	NS	47,70 /pair	CR	47,70 /pair
				CP	47,70 /pair	GR	43,50 /pair		
F. 13	 123 22	V-1781 DALI	1 pair	CS	129,70 /pair	NS	129,70 /pair	CR	129,70 /pair
F. 14	 125 20	V-1761 CASTO	1 pair	CS	94,30 /pair	NS	94,30 /pair	CR	94,30 /pair
				OL	94,30 /pair	CP	105,30 /pair		

POS.	PROD.	ART.	Q.TÀ	FIN.	EURO	FIN.	EURO	FIN.	EURO
F. 15		V-1691 GO-GO	1 pair	CS	108,70 /pair	NS	108,70 /pair	CR	108,70 /pair
				OL	108,70 /pair				
F. 16		V-1681 VOLA	1 pair	CS	108,70 /pair	NS	108,70 /pair	CR	108,70 /pair
				OL	108,70 /pair				
F. 17		V-140 DAYTONA	1 pair	CS	81,30 /pair	NS	81,30 /pair	CR	81,30 /pair
				OL	81,30 /pair	CP	81,30 /pair		
F. 18		V-111 MILANO	1 pair	CS	50,70 /pair	NS	50,70 /pair	CR	50,70 /pair
				OL	50,70 /pair	CP	50,70 /pair		
F. 19		V-110 U-FORM	1 pair	IX	35,00 /pair	AN	35,00 /pair		
				IX	32,30 /pair	AN	32,30 /pair		
F. 20		V-1801 TECNO	1 pair	CS	74,00 /pair	NS	74,00 /pair	CR	74,00 /pair
F. 21		V-1751 SOLE	1 pair	CS	70,50 /pair	NS	70,50 /pair	CR	70,50 /pair
				OL	70,50 /pair	CP	70,50 /pair		

- Confezioni industriali
- Industrial packaging
- Industrieverpackungen

- **min**
- Prezzi speciali per l'acquisto delle quantità minime indicate dell'articolo
NB eventuali riordini o aggiunte per completamenti se di quantità inferiore alla minima, saranno fatturati al prezzo normale
- Special prices for the purchase of the minimum quantities indicated of the article
Note Well: any reorders or additions for completions of quantity less than the minimum will be invoiced at the normal price
- Artikel mit Sonderpreisen bei Mindestabnahmemengen sind mit gekennzeichnet
Nachbestellungen oder Ergänzungen unter der Mindestabnahmemenge werden mit dem Normalpreis verrechnet

POS.	PROD.	ART.	Q.TÀ	FIN.	EURO	FIN.	EURO	FIN.	EURO
F. 22									
F. 23	 120 20	V-141 CAPRI	1 pair	CS	44,00 /pair	NS	44,00 /pair	CR	44,00 /pair
				OL	44,00 /pair				
F. 24									
F. 25	 120 19	V-121 SABBIA	1 pair	CS	44,00 /pair	NS	44,00 /pair	CR	44,00 /pair
				OL	44,00 /pair	CP	44,00 /pair		
F. 26	 128 25	V-1791 WIND	1 pair	CS	129,70 /pair	NS	129,70 /pair	CR	129,70 /pair
F. 27	 136 20	V-1771 AMLETO	1 pair	CS	149,00 /pair	NS	149,00 /pair	CR	149,00 /pair
F. 28	 130 27	V-1391 VITREA COLOR	1 pair	CS	162,50 /pair	NS	162,50 /pair	CR	162,50 /pair
				OL	162,50 /pair				

POS.	PROD.	ART.	Q.TÀ	FIN.	EURO	FIN.	EURO	FIN.	EURO
ROSETTE <i>ROSETTE / ROSETTE</i>					▶ INDOOR 157				
<ul style="list-style-type: none"> EXTRA: per maniglie con rosette per porte in legno EXTRA: for doorhandles with rosette for wooden doors AUFPREISE: für Türgriffe mit Rosette für Holztüren 									
F. 29		ROS-T-BB	1 set	CS	95,30 /set	NS	95,30 /set	CR	95,30 /set
				OL	95,30 /set	CP	95,30 /set		
F. 30		ROS-Q-BB	1 set	CS	98,30 /set	NS	98,30 /set	CR	98,30 /set
				OL	98,30 /set	CP	98,30 /set		
F. 31		ROS-T-PZ	1 set	CS	95,30 /set	NS	95,30 /set	CR	95,30 /set
				OL	95,30 /set	CP	95,30 /set		
F. 32		ROS-Q-PZ	1 set	CS	98,30 /set	NS	98,30 /set	CR	98,30 /set
				OL	98,30 /set	CP	98,30 /set		
F. 33		ROS-T-WC	1 set	CS	117,70 /set	NS	117,70 /set	CR	117,70 /set
				OL	117,70 /set	CP	117,70 /set		
F. 34		ROS-Q-WC	1 set	CS	120,30 /set	NS	120,30 /set	CR	120,30 /set
				OL	120,30 /set	CP	120,30 /set		

■
 • Confezioni industriali
 • Industrial packaging
 • Industrieverpackungen

■ min
 • Prezzi speciali per l'acquisto delle quantità minime indicate dell'articolo
 NB eventuali riordini o aggiunte per completamenti se di quantità inferiore alla minima, saranno fatturati al prezzo normale
 • Special prices for the purchase of the minimum quantities indicated of the article
 Note Well: any reorders or additions for completions of quantity less than the minimum will be invoiced at the normal price
 • Artikel mit Sonderpreisen bei Mindestabnahmemengen sind mit gekennzeichnet
 Nachbestellungen oder Ergänzungen unter der Mindestabnahmemenge werden mit dem Normalpreis verrechnet

POS.	PROD.	ART.	MIS.	Q.TÀ	FIN.	EURO	FIN.	EURO	FIN.	EURO
------	-------	------	------	------	------	------	------	------	------	------

MANIGLIONI AD INCOLLAGGIO

PULLHANDLES WITH SELF-ADHESIVE / STOSSGRIFFE SELBSTKLEBEND

► INDOOR 158



- Pulire con solvente
- Clean with solvent
- Mit Lösungsmittel reinigen



- Asciugare con un panno
- Dry with a cloth
- Mit einem Tuch trocken



- Staccare la pellicola protettiva e applicare
- Remove the protective film and apply
- Die Schutzfolie abziehen und anbringen

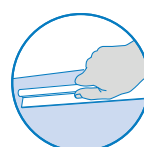

- Premere con forza
- Press firmly
- Fest drücken

MANIGLIONI AD INCOLLAGGIO "SQUARE 10-INC"

PULLHANDLES WITH SELF-ADHESIVE / STOSSGRIFFE SELBSTKLEBEND

**Materiale
Material
Material**

<p>F. 35</p>	<p>10.41.81/300</p> <p>10 x 15 mm TL = 300 mm</p>	1 pc	AN	42,00 /pc	<p>Alluminio Aluminium Aluminium</p>
		■ min 10 pcs	AN	27,00 /pc	
	<p>10.41.51/300</p> <p>10 x 15 mm TL = 300 mm</p>	1 pc	CR	81,70 /pc	<p>Ottone Brass Messing</p>
		■ min 10 pcs	CR	50,70 /pc	
	<p>10.41.61/300</p> <p>10 x 15 mm TL = 300 mm</p>	1 pc	AL	50,70 /pc	<p>Alluminio CR effect Aluminium CR effect Aluminium CR effect</p>
		■ min 10 pcs	AL	30,30 /pc	
	<p>10.41.71/300</p> <p>10 x 15 mm TL = 300 mm</p>	1 pc	NO	64,70 /pc	<p>Alluminio Aluminium Aluminium</p>
		■ min 10 pcs	NO	35,00 /pc	
<p>10.41.81/500</p> <p>10 x 15 mm TL = 500 mm</p>	1 pc	AN	49,30 /pc	<p>Alluminio Aluminium Aluminium</p>	
	■ min 10 pcs	AN	31,30 /pc		
<p>10.41.51/500</p> <p>10 x 15 mm TL = 500 mm</p>	1 pc	CR	100,70 /pc	<p>Ottone Brass Messing</p>	
	■ min 10 pcs	CR	66,30 /pc		
<p>10.41.61/500</p> <p>10 x 15 mm TL = 500 mm</p>	1 pc	AL	62,70 /pc	<p>Alluminio CR effect Aluminium CR effect Aluminium CR effect</p>	
	■ min 10 pcs	AL	34,00 /pc		
<p>10.41.71/500</p> <p>10 x 15 mm TL = 500 mm</p>	1 pc	NO	53,70 /pc	<p>Alluminio Aluminium Aluminium</p>	
	■ min 10 pcs	NO	33,50 /pc		

POS.	PROD.	ART.	MIS.	Q.TÀ	FIN.	EURO	FIN.	EURO	FIN.	EURO				
F.36		POR-0400V	B = 240 mm C = 23 mm	1 pc	AN	44,00 /pc	AL	56,50 /pc	NS NO	52,30 /pc				
					CR	/pc								
				■ min 10 pcs	AN	34,00 /pc	AL	46,70 /pc	NS NO	42,50 /pc				
					CR	/pc								
				1 pc	AN	59,00 /pc	AL	73,30 /pc	NS NO	73,50 /pc				
					CR	/pc								
■ min 10 pcs	AN	49,00 /pc	AL	63,30 /pc	NS NO	63,70 /pc								
	CR	/pc												
F.37		POR-0408V	B = 540 mm C = 23 mm	1 pc	AN	80,30 /pc	AL	86,70 /pc	NS NO	85,30 /pc				
					CR	/pc								
				■ min 10 pcs	AN	70,30 /pc	AL	76,70 /pc	NS NO	75,30 /pc				
					CR	/pc								
				F.37		POR-0408V	B = 260 mm C = 17 mm	1 pc	AN	44,00 /pc	AL	55,30 /pc	IXO NO	51,30 /pc
									BI BC BS	85,50 /pc	CR	85,50 /pc		
■ min 10 pcs	AN	25,30 /pc	AL					45,30 /pc	IXO NO	40,00 /pc				
	BI BC BS	59,50 /pc	CR					59,50 /pc						
1 pc	AN	50,30 /pc	AL					69,70 /pc	IXO NO	57,00 /pc				
	BI BC BS	97,00 /pc	CR					97,00 /pc						
■ min 10 pcs	AN	33,30 /pc	AL	59,50 /pc	IXO NO	46,00 /pc								
	BI BC BS	68,50 /pc	CR	68,50 /pc										
F.37		POR-0408V	B = 410 mm C = 17 mm	1 pc	AN	69,70 /pc	AL	87,00 /pc	NS	98,00 /pc				
					CR	/pc								
				■ min 10 pcs	AN	60,00 /pc	AL	77,50 /pc	NS	87,70 /pc				
					CR	/pc								

- Confezioni industriali
- Industrial packaging
- Industrieverpackungen

■ min

- Prezzi speciali per l'acquisto delle quantità minime indicate dell'articolo
NB eventuali riordini o aggiunte per completamenti se di quantità inferiore alla minima, saranno fatturati al prezzo normale
- Special prices for the purchase of the minimum quantities indicated of the article
Note Well: any reorders or additions for completions of quantity less than the minimum will be invoiced at the normal price
- Artikel mit Sonderpreisen bei Mindestabnahmemengen sind mit gekennzeichnet
Nachbestellungen oder Ergänzungen unter der Mindestabnahmemenge werden mit dem Normalpreis verrechnet

POS.	PROD.	ART.	MIS.	Q.TÀ	FIN.	EURO	FIN.	EURO	FIN.	EURO	
MANIGLIONI										► INDOOR 160	
PULLHANDLES / STOSSGRIFFE											
MANIGLIONI "SQUARE 10"								Materiale			
PULLHANDLES SQUARE 10 / STOSSGRIFFE SQUARE 10								Material			
F.38		10.41.53/290.300	10 x 15 mm TL = 300 mm A = 290 mm 8 mm hole	1 pair	CR	108,00/pair				Ottone Brass Messing	
			8 mm hole	min 10 pairs	CR	79,30/pair					
		10.41.63/290.300	10 x 15 mm TL = 300 mm A = 290 mm 8 mm hole	1 pair	AL	60,00/pair					Alluminio CR effect Aluminium CR effect Aluminium CR effect
			8 mm hole	min 10 pairs	AL	38,50/pair					
		10.41.73/290.300	10 x 15 mm TL = 300 mm A = 290 mm 8 mm hole	1 pair	NO	66,30/pair					Alluminio Aluminium Aluminium
			8 mm hole	min 10 pairs	NO	40,00/pair					
		10.41.53/490.500	10 x 15 mm TL = 500 mm A = 490 mm 8 mm hole	1 pair	CR	143,50/pair					Ottone Brass Messing
			8 mm hole	min 10 pairs	CR	110,00/pair					
		10.41.63/490.500	10 x 15 mm TL = 500 mm A = 490 mm 8 mm hole	1 pair	AL	61,50/pair					Alluminio CR effect Aluminium CR effect Aluminium CR effect
			8 mm hole	min 10 pairs	AL	46,00/pair					
MANIGLIONI "ZAMA"										► INDOOR	
PULLHANDLES ZAMAK / STOSSGRIFFE ZAMAK											
F.39		SQ01	Ø 16 mm TL = 200 mm A = 160 mm 6 mm hole M 4 hole	1 pair	CR	73,00/pair					
		SQ02	Ø 16 mm TL = 200 mm A = 160 mm 6 mm hole M 4 hole	1 pc	CR	63,30/pc					

POS.	PROD.	ART.	MIS.	Q.TÀ	FIN.	EURO	FIN.	EURO	FIN.	EURO
MANIGLIONI MINI ALLUMINIO "SQUARE ALU Ø 14" ▶ INDOOR 160										
<i>PULLHANDLES MINI ALUMINIUM / MINI STOSSGRIFFE ALU</i>										
		14.41.43/0160.174		1 pair	AN	122,00 /pair				
				■ min 10 pairs	AN	112,70 /pair				
		14.41.53/0160.174	Ø 14 mm TL = 174 mm A = 160 mm B = 38 mm	1 pair	CR	192,50 /pair				
				■ min 10 pairs	CR	183,30 /pair				
		14.41.63/0160.174	Ø = 8,5 mm	1 pair	NS	/pair				
				■ min 10 pairs	NS	/pair				
		14.41.73/0160.174		1 pair	NO	/pair				
				■ min 10 pairs	NO	/pair				
		14.41.43/0192.206		1 pair	AN	139,00 /pair				
				■ min 10 pairs	AN	128,70 /pair				
		14.41.53/0192.206	Ø 14 mm TL = 206 mm A = 192 mm B = 38 mm	1 pair	CR	206,70 /pair				
				■ min 10 pairs	CR	197,50 /pair				
		14.41.63/0192.206	Ø = 8,5 mm	1 pair	NS	/pair				
				■ min 10 pairs	NS	/pair				
		14.41.73/0192.206		1 pair	NO	/pair				
				■ min 10 pairs	NO	/pair				
		14.41.43/0320.334		1 pair	AN	148,30 /pair				
				■ min 10 pairs	AN	138,30 /pair				
		14.41.53/0320.334	Ø 14 mm TL = 334 mm A = 320 mm B = 38 mm	1 pair	CR	208,00 /pair				
				■ min 10 pairs	CR	197,50 /pair				
		14.41.63/0320.334	Ø = 8,5 mm	1 pair	NS	/pair				
				■ min 10 pairs	NS	/pair				
		14.41.73/0320.334		1 pair	NO	/pair				
				■ min 10 pairs	NO	/pair				

- Confezioni industriali
- Industrial packaging
- Industrieverpackungen

■ min

- Prezzi speciali per l'acquisto delle quantità minime indicate dell'articolo
NB eventuali riordini o aggiunte per completamenti se di quantità inferiore alla minima, saranno fatturati al prezzo normale
- Special prices for the purchase of the minimum quantities indicated of the article
Note Well: any reorders or additions for completions of quantity less than the minimum will be invoiced at the normal price
- Artikel mit Sonderpreisen bei Mindestabnahmemengen sind mit gekennzeichnet
Nachbestellungen oder Ergänzungen unter der Mindestabnahmemenge werden mit dem Normalpreis verrechnet

POS.	PROD.	ART.	MIS.	Q.TÀ	FIN.	EURO	FIN.	EURO	FIN.	EURO
MANIGLIONI MINI INOX "SQUARE MINI 15" ▶ INDOOR 160 PULLHANDLES MINI INOX / STOSSGRIFFE MINI INOX										
F. 41 	15.41.13/135.150 □ 15 mm TL = 150 mm A = 135 mm = 9 mm = M 5	1 pair	IX	79,50/pair						
		■ min 10 pairs	IX	57,70/pair						
	15.41.53/135.150 □ 15 mm TL = 150 mm A = 135 mm = 9 mm = M 5	1 pair	IL	84,30/pair						
		■ min 10 pairs	IL	61,50/pair						
	15.41.13/200.215 □ 15 mm TL = 215 mm A = 200 mm = 9 mm = M 5	1 pair	IX	80,70/pair						
		■ min 10 pairs	IX	59,30/pair						
15.41.53/200.215 □ 15 mm TL = 215 mm A = 200 mm = 9 mm = M 5	1 pair	IL	88,70/pair							
	■ min 10 pairs	IL	67,50/pair							
15.41.13/300.315 □ 15 mm TL = 315 mm A = 300 mm = 9 mm = M 5	1 pair	IX	83,00/pair							
	■ min 10 pairs	IX	62,30/pair							
15.41.53/300.315 □ 15 mm TL = 315 mm A = 300 mm = 9 mm = M 5	1 pair	IL	95,50/pair							
	■ min 10 pairs	IL	73,50/pair							
F. 42 	B-178 □ 15 mm	1 pair	CR	88,70/pair	NS	88,70/pair				
	B-178 □ 15 mm	■ min 10 pairs	CR	68,30/pair	NS	68,30/pair				
<ul style="list-style-type: none"> • Possibilità di utilizzo con maniglioni "MINI" Q.15 montati su box doccia set 1 per evitare contatto all'interno. Per questa versione è necessario ordinare due paia di pomoli ed 1 paio di maniglioni mini • Possible to use with Mini pullhandles Q.15 for Set 1 shower system to avoid the contact of the handles in the inside. For this version it's necessary to order one pair Mini pullhandles and two pairs knobs Mini • Um den Kontakt der Beschläge auf der Innenseite des Duschsystem Set1 zu vermeiden, ist es notwendig ein Paar Mini Stossgriffe Q.15 und 2 Paar Mini Knöpfe zu verwenden 										

POS.	PROD.	ART.	MIS.	Q.TÀ	FIN.	EURO	FIN.	EURO	FIN.	EURO
F. 43		FIX-01-MINI		1 set	IX	24,30/set	IL	26,50/set		
<ul style="list-style-type: none"> • Set fissaggio singolo per maniglioni MINI inox. Opzionale con Round MINI, Square MINI, B-177 e B-178 • Set installation for single pullhandles MINI inox. Optional with Round MINI, Square MINI, B-177 and B-178 • Befestigungsset für 1 Stück Stossgriff MINI. Optional mit Round MINI, Square MINI, B-177 und B-178 										

MANIGLIONI MINI INOX "ROUND MINI Ø 16" ▶ INDOOR 160
PULLHANDLES MINI INOX / STOSSGRIFFE MINI INOX

F.44			16.02.13/135.225 Ø 16 mm TL = 225 mm A = 135 mm = 9 mm = M 5	1 pair	IX	67,00/pair		
				min 10 pairs	IX	47,00/pair		
			16.02.53/135.225 Ø 16 mm TL = 225 mm A = 135 mm = 9 mm = M 5	1 pair	IL	78,50/pair		
				min 10 pairs	IL	57,00/pair		
			16.02.13/200.300 Ø 16 mm TL = 300 mm A = 200 mm = 9 mm = M 5	1 pair	IX	69,30/pair		
				min 10 pairs	IX	49,00/pair		
			16.02.53/200.300 Ø 16 mm TL = 300 mm A = 200 mm = 9 mm = M 5	1 pair	IL	83,00/pair		
				min 10 pairs	IL	60,00/pair		

F. 45		B-177	Ø 15 mm	1 pair	IL	69,70/pair	IX	69,70/pair
		B-177	Ø 15 mm	min 10 pairs	IL	59,50/pair	IX	59,50/pair

- Possibilità di utilizzo con maniglioni "MINI" D.16 montati su box doccia set 1 per evitare contatto all'interno. Per questa versione è necessario ordinare due paia di pomoli ed 1 paio di maniglioni mini
- Possible to use with Mini pullhandles D.16 for Set 1 shower system to avoid the contact of the handles in the inside. For this version it's necessary to order one pair Mini pullhandles and two pairs knobs
- Mini Um den Kontakt der Beschläge auf der Innenseite des Duschsystem Set1 zu vermeiden, ist es notwendig ein Paar Mini Stossgriffe D.16 und 2 Paar Mini Knöpfe zu verwenden

- Confezioni industriali**
- Industrial packaging**
- Industrieverpackungen**

- min**
- Prezzi speciali per l'acquisto delle quantità minime indicate dell'articolo
NB eventuali riordini o aggiunte per completamenti se di quantità inferiore alla minima, saranno fatturati al prezzo normale
- Special prices for the purchase of the minimum quantities indicated of the article
Note Well: any reorders or additions for completions of quantity less than the minimum will be invoiced at the normal price
- Artikel mit Sonderpreisen bei Mindestabnahmemengen sind mit gekennzeichnet
Nachbestellungen oder Ergänzungen unter der Mindestabnahmemenge werden mit dem Normalpreis verrechnet

POS.	PROD.	ART.	MIS.				Q.TÀ	FIN.	EURO	
MANIGLIONI INOX "ROUND 02"										
PULLHANDLES INOX / STOSSGRIFFE INOX										
▶ INDOOR 161										
 			Ø	A	B	TL				
	20.02.11/0200.0300		Ø 20 mm	200	65	300	M6	10	1 pc	IX 69,30 /pc
	20.02.13/0200.0300		Ø 20 mm	200	65	300	M6	10	1 pair	IX 77,50 /pair
									min 10 pairs	IX 63,00 /pair
	20.02.11/0300.0400		Ø 20 mm	300	65	400	M6	10	1 pc	IX 74,30 /pc
	20.02.13/0300.0400		Ø 20 mm	300	65	400	M6	10	1 pair	IX 85,30 /pair
									min 10 pairs	IX 72,00 /pair
	20.02.11/0500.0700		Ø 20 mm	500	65	700	M6	10	1 pc	IX 112,70 /pc
	20.02.13/0500.0700		Ø 20 mm	500	65	700	M6	10	1 pair	IX 138,00 /pair
									min 10 pairs	IX 113,30 /pair
	20.02.11/1040.1200		Ø 20 mm	1040	65	1200	M6	10	1 pc	IX 140,00 /pc
	20.02.13/1040.1200		Ø 20 mm	1040	65	1200	M6	10	1 pair	IX 197,50 /pair
									min 10 pairs	IX 168,00 /pair
	25.02.11/0300.0500		Ø 25 mm	300	75	500	M6	12	1 pc	IX 83,00 /pc
	25.02.13/0300.0500		Ø 25 mm	300	75	500	M6	12	1 pair	IX 100,00 /pair
									min 10 pairs	IX 85,30 /pair
	25.02.11/0500.0700		Ø 25 mm	500	75	700	M6	12	1 pc	IX 125,30 /pc
	25.02.13/0500.0700		Ø 25 mm	500	75	700	M6	12	1 pair	IX 158,50 /pair
									min 10 pairs	IX 122,00 /pair
25.02.11/0650.0850		Ø 25 mm	650	75	850	M6	12	1 pc	IX 133,30 /pc	
25.02.13/0650.0850		Ø 25 mm	650	75	850	M6	12	1 pair	IX 181,70 /pair	
								min 10 pairs	IX 141,70 /pair	
30.02.11/0500.0700		Ø 30 mm	500	75	700	M8	12	1 pc	IX 135,70 /pc	
30.02.13/0500.0700		Ø 30 mm	500	75	700	M8	12	1 pair	IX 193,00 /pair	
								min 10 pairs	IX 149,30 /pair	
30.02.11/1000.1200		Ø 30 mm	1000	75	1200	M8	12	1 pc	IX 181,70 /pc	
30.02.13/1000.1200		Ø 30 mm	1000	75	1200	M8	12	2 pairs	IX 293,70 /pair	
								min 10 pairs	IX 237,50 /pair	
30.02.11/1370.1650		Ø 30 mm	1370	75	1650	M8	12	1 pc	IX 275,30 /pc	
30.02.13/1370.1650		Ø 30 mm	1370	75	1650	M8	12	1 pair	IX 423,50 /pair	
								min 10 pairs	IX 350,30 /pair	

POS.	PROD.	ART.	MIS.					Q.TÀ	FIN.	EURO
			Ø	A	TL	B				
		20.02.51/0200.0300	Ø 20 mm	200	300	65	M6	10	1 pc	IL 79,50 /pc
		20.02.53/0200.0300	Ø 20 mm	200	300	65	M6	10	1 pair	IL 90,00 /pair
	min 10 pairs								IL 73,50 /pair	
		20.02.51/0500.0700	Ø 20 mm	500	700	65	M6	10	1 pc	IL 119,50 /pc
		20.02.53/0500.0700	Ø 20 mm	500	700	65	M6	10	1 pair	IL 163,00 /pair
	min 10 pairs								IL 133,30 /pair	
		25.02.51/0300.0500	Ø 25 mm	300	500	75	M6	12	1 pc	IL 103,00 /pc
		25.02.53/0300.0500	Ø 25 mm	300	500	75	M6	12	1 pair	IL 121,00 /pair
	min 10 pairs								IL 104,00 /pair	

MANIGLIONI INOX "ROUND 10"
PULLHANDLES INOX / STOSSGRIFFE INOX

► INDOOR 161

			Ø	A	TL	B				
		20.10.11/0300.0000	Ø 20 mm	300	-	65	M6	10	1 pc	IX 80,70 /pc
		20.10.13/0300.0000	Ø 20 mm	300	-	65	M6	10	1 pair	IX 97,00 /pair
	min 10 pairs								IX 81,00 /pair	
		25.10.11/0300.0000	Ø 25 mm	300	-	75	M8	12	1 pc	IX 86,00 /pc
		25.10.13/0300.0000	Ø 25 mm	300	-	75	M8	12	1 pair	IX 107,30 /pair
	min 10 pairs								IX 90,30 /pair	
		25.10.11/0650.0000	Ø 25 mm	650	-	75	M8	12	1 pc	IX 113,30 /pc
		25.10.13/0650.0000	Ø 25 mm	650	-	75	M8	12	1 pair	IX 155,50 /pair
	min 10 pairs								IX 135,70 /pair	
		30.10.11/1000.0000	Ø 30 mm	1000	-	75	M8	12	1 pc	IX 213,50 /pc
		30.10.13/1000.0000	Ø 30 mm	1000	-	75	M8	12	1 pair	IX 262,00 /pair
	min 10 pairs								IX 243,30 /pair	

F. 47

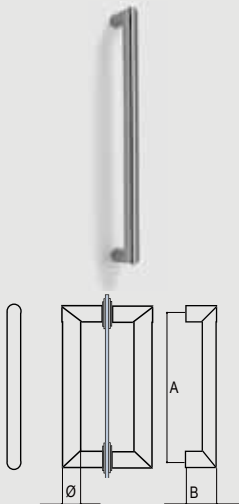

- Confezioni industriali
- Industrial packaging
- Industrieverpackungen

- min**
- Prezzi speciali per l'acquisto delle quantità minime indicate dell'articolo
NB eventuali riordini o aggiunte per completamenti se di quantità inferiore alla minima, saranno fatturati al prezzo normale
- Special prices for the purchase of the minimum quantities indicated of the article
Note Well: any reorders or additions for completions of quantity less than the minimum will be invoiced at the normal price
- Artikel mit Sonderpreisen bei Mindestabnahmemengen sind mit gekennzeichnet
Nachbestellungen oder Ergänzungen unter der Mindestabnahmemenge werden mit dem Normalpreis verrechnet

POS.	PROD.	ART.	MIS.					Q.TÀ	FIN.	EURO
MANIGLIONI INOX "SQUARE 41"										
<i>PULLHANDLES INOX / STOSSGRIFFE INOX</i>										
▶ INDOOR 161										
F. 48			∅	A	TL	B				
		19.41.13/0200.0000	∅ 19 mm	200	-	60	M6	10	1 pair	IX 88,00 /pair
									min 10 pairs	IX 72,00 /pair
		19.41.53/0200.0000	∅ 19 mm	200	-	60	M6	10	1 pair	IL 107,30 /pair
									min 10 pairs	IL 90,50 /pair
		25.41.11/0300.0000	∅ 25 mm	300	-	70	M8	12	1 pc	IX 98,00 /pc
		25.41.13/0300.0000	∅ 25 mm	300	-	70	M8	12	1 pair	IX 125,30 /pair
									min 10 pairs	IX 103,00 /pair
		25.41.51/0300.0000	∅ 25 mm	300	-	70	M8	12	1 pc	IL 118,00 /pc
		25.41.53/0300.0000	∅ 25 mm	300	-	70	M8	12	1 pair	IL 150,70 /pair
							min 10 pairs	IL 134,70 /pair		
40.41.11/0650.0000	∅ 40 mm	650	-	88	M8	12	1 pc	IX 225,30 /pc		
40.41.13/0650.0000	∅ 40 mm	650	-	88	M8	12	1 pair	IX 306,00 /pair		
							min 10 pairs	IX 285,70 /pair		

MANIGLIONI INOX "SQUARE 40"										
<i>PULLHANDLES INOX / STOSSGRIFFE INOX</i>										
▶ INDOOR 161										
F. 49			∅	A	B	TL				
		25.40.11/0300.0400	∅ 25 mm	300	70	400	M8	12	1 pc	IX 113,00 /pc
		25.40.13/0300.0400	∅ 25 mm	300	70	400	M8	12	1 pair	IX 140,00 /pair
									min 10 pairs	IX 122,00 /pair
		25.40.53/0300.0500	∅ 25 mm	300	70	400	M8	12	1 pair	IL 187,00 /pair
									min 10 pairs	IL 168,30 /pair

POS.	PROD.	ART.	MIS.					Q.TÀ	FIN.	EURO
MANIGLIONI INOX "ROUND 01"										
<i>PULLHANDLES INOX / STOSSGRIFFE INOX</i>										
▶ INDOOR 161										
<p>F. 50</p>			Ø	A	TL	B				
	20.01.11/0200.0000		Ø 20 mm	200	-	65	M6	10	1 pc	IX 76,70 /pc
	20.01.13/0200.0000		Ø 20 mm	200	-	65	M6	10	1 pair	IX 90,00 /pair
		min 10 pairs							IX 75,00 /pair	
	20.01.11/0300.0000		Ø 20 mm	300	-	65	M6	10	1 pc	IX 88,70 /pc
	20.01.13/0300.0000		Ø 20 mm	300	-	65	M6	10	1 pair	IX 98,00 /pair
		min 10 pairs							IX 83,00 /pair	
	20.01.11/0400.0000		Ø 20 mm	400	-	65	M6	10	1 pc	IX 94,50 /pc
	20.01.13/0400.0000		Ø 20 mm	400	-	65	M6	10	1 pair	IX 106,00 /pair
		min 10 pairs							IX 92,00 /pair	
	25.01.11/0300.0000		Ø 25 mm	300	-	75	M8	12	1 pc	IX 103,50 /pc
	25.01.13/0300.0000		Ø 25 mm	300	-	75	M8	12	1 pair	IX 115,00 /pair
		min 10 pairs							IX 99,70 /pair	
	25.01.11/0350.0000		Ø 25 mm	350	-	75	M8	12	1 pc	IX 121,00 /pc
	25.01.13/0350.0000		Ø 25 mm	350	-	75	M8	12	1 pair	IX 132,00 /pair
		min 10 pairs							IX 117,50 /pair	
	25.01.11/0650.0000		Ø 25 mm	650	-	75	M8	12	1 pc	IX 149,30 /pc
	25.01.13/0650.0000		Ø 25 mm	650	-	75	M8	12	1 pair	IX 234,30 /pair
	30.01.11/0350.0000		Ø 30 mm	350	-	75	M8	12	1 pc	IX 149,30 /pc
	30.01.13/0350.0000		Ø 30 mm	350	-	75	M8	12	1 pair	IX 234,30 /pair
30.01.11/0650.0000		Ø 30 mm	650	-	75	M8	12	1 pc	IX 183,50 /pc	
30.01.13/0650.0000		Ø 30 mm	650	-	75	M8	12	1 pair	IX 281,30 /pair	



- Confezioni industriali
- Industrial packaging
- Industrieverpackungen









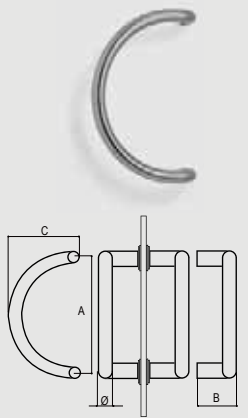

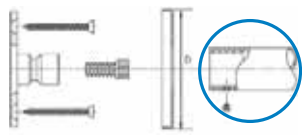
- min**
- Prezzi speciali per l'acquisto delle quantità minime indicate dell'articolo
- NB eventuali riordini o aggiunte per completamenti se di quantità inferiore alla minima, saranno fatturati al prezzo normale
- Special prices for the purchase of the minimum quantities indicated of the article
- Note Well: any reorders or additions for completions of quantity less than the minimum will be invoiced at the normal price
- Artikel mit Sonderpreisen bei Mindestabnahmemengen sind mit gekennzeichnet
- Nachbestellungen oder Ergänzungen unter der Mindestabnahmemenge werden mit dem Normalpreis verrechnet

POS.	PROD.	ART.	MIS.							Q.TÀ	FIN.	EURO
MANIGLIONI INOX "ROUND 11"												
<i>PULLHANDLES INOX / STOSSGRIFFE INOX</i>											▶ INDOOR 161	
F. 51			Ø	A	TL	B	C					
		25.11.11/0350.0420	Ø 25 mm	350	420	75	75	M6	12	1 pc	IX 185,00 /pc	
		25.11.13/0350.0420	Ø 25 mm	350	420	75	75	M6	12	1 pair	IX 291,30 /pair	
		25.11.11/0620.0665	Ø 25 mm	620	665	75	75	M6	12	1 pc	IX 193,30 /pc	
		25.11.13/0620.0665	Ø 25 mm	620	665	75	75	M6	12	1 pair	IX 298,00 /pair	
MANIGLIONI INOX "ROUND 08"												
<i>PULLHANDLES INOX / STOSSGRIFFE INOX</i>											▶ INDOOR 162	
F. 52			Ø	A	TL	B	C					
		25.08.11/0300.0000	Ø 32 mm	400	432	75	250	M8	12	1 pc	IX 185,00 /pc	
		25.08.13/0300.0000	Ø 32 mm	400	432	75	250	M8	12	1 pair	IX 291,30 /pair	
MANIGLIONI INOX "ROUND 03"												
<i>PULLHANDLES INOX / STOSSGRIFFE INOX</i>											▶ INDOOR 162	
F. 53			Ø	A	TL	B	C					
		25.03.11/0275.0000	Ø 25 mm	275	-	75	-	M8	12	1 pc	IX 169,00 /pc	
		25.03.13/0275.0000	Ø 25 mm	275	-	75	-	M8	12	1 pair	IX 266,30 /pair	
		30.03.11/0350.0000	Ø 30 mm	350	-	75	-	M8	12	1 pc	IX 208,30 /pc	
		30.03.13/0350.0000	Ø 30 mm	350	-	75	-	M8	12	1 pair	IX 381,30 /pair	
		30.03.11/0650.0000	Ø 30 mm	350	-	75	-	M8	12	1 pc	IX 326,00 /pc	
		30.03.13/0650.0000	Ø 30 mm	350	-	75	-	M8	12	1 pair	IX 604,00 /pair	

POS.	PROD.	ART.	MIS.	Q.TÀ	FIN.	EURO
------	-------	------	------	------	------	------

MANIGLIONI INOX "ROUND 09"
PULLHANDLES INOX / STOSSGRIFFE INOX ▶ INDOOR 162

	Ø	A	TL	B	C						
<p>F. 54</p> 	25.09.11/0300.0000	Ø 32 mm	300	332	75	175	M8	12	1 pc	IX	185,00 /pc
	25.09.13/0300.0000	Ø 32 mm	300	332	75	175	M8	12	1 pair	IX	291,30 /pair

POS.	PROD.	ART.	Q.TÀ	FIN.	EURO
SET FISSAGGIO SCIOLTI <i>FIXATION SYSTEMS / BEFESTIGUNGSSYSTEME</i>					▶ INDOOR 162
	 <ul style="list-style-type: none"> • Per porta legno ordinare sempre dalla coppia maniglione la parte con i grani di fissaggio • For wooden doors please order always from the pair pullhandles the side with grub screws • Für Holztür bitte immer bestellen von paar Stossgriffe die Seite mit Inbussschrauben 				
F. 55		FIX-01-20	1 set	IX	33,00 /set
F. 56		FIX-01-25	1 set	IX	33,00 /set
F. 57		FIX-01-30	1 set	IX	33,00 /set
F. 58		FIX-03-20	1 set	IX	28,30 /set
F. 59		FIX-03-25	1 set	IX	28,30 /set
F. 60		FIX-03-30	1 set	IX	28,30 /set
F. 61		FIX-09-20	1 set	IX	33,00 /set
F. 62		FIX-09-25	1 set	IX	33,00 /set
F. 63		FIX-09-30	1 set	IX	33,00 /set

POS.	PROD.	MIS.	FIN.	EURO
------	-------	------	------	------

MANIGLIONI TAGLIATI SU MISURA

CUSTOM MADE PULLHANDLES / STOSSGRIFFE MIT EINEM SONDERMASS

F. 64		TL	Ø		FIN.	Fiss. A2	Fiss. A3	Fiss. A4
		fino a 400 mm	Ø 25 mm	12	IX	558,70 /pc	650,70 /pc	740,00 /pc
	Ø 30 mm	12	IX	631,50 /pc	730,50 /pc	830,30 /pc		
da 401 a 700 mm	Ø 25 mm	12	IX	584,50 /pc	674,30 /pc	766,50 /pc		
	Ø 30 mm	12	IX	659,00 /pc	758,70 /pc	859,00 /pc		
da 701 a 1000 mm	Ø 25 mm	12	IX	609,00 /pc	699,30 /pc	789,30 /pc		
	Ø 30 mm	12	IX	687,30 /pc	787,30 /pc	887,70 /pc		
da 1001 a 1300 mm	Ø 25 mm	12	IX	631,50 /pc	723,00 /pc	813,50 /pc		
	Ø 30 mm	12	IX	716,30 /pc	816,00 /pc	916,50 /pc		
da 1301 a 1600 mm	Ø 25 mm	12	IX	655,30 /pc	746,30 /pc	838,00 /pc		
	Ø 30 mm	12	IX	744,70 /pc	844,50 /pc	945,00 /pc		
da 1601 a 1900 mm	Ø 25 mm	12	IX	680,30 /pc	770,30 /pc	859,00 /pc		
	Ø 30 mm	12	IX	773,30 /pc	873,30 /pc	986,00 /pc		
da 1901 a 2200 mm	Ø 25 mm	12	IX	705,00 /pc	794,30 /pc	884,70 /pc		
	Ø 30 mm	12	IX	802,00 /pc	901,70 /pc	994,30 /pc		
da 2201 a 2500 mm	Ø 25 mm	12	IX	733,70 /pc	818,70 /pc	909,50 /pc		
	Ø 30 mm	12	IX	830,30 /pc	930,00 /pc	1023,30 /pc		
da 2501 a 2900 mm	Ø 25 mm	12	IX	760,70 /pc	851,50 /pc	942,30 /pc		
	Ø 30 mm	12	IX	865,70 /pc	966,30 /pc	1066,50 /pc		

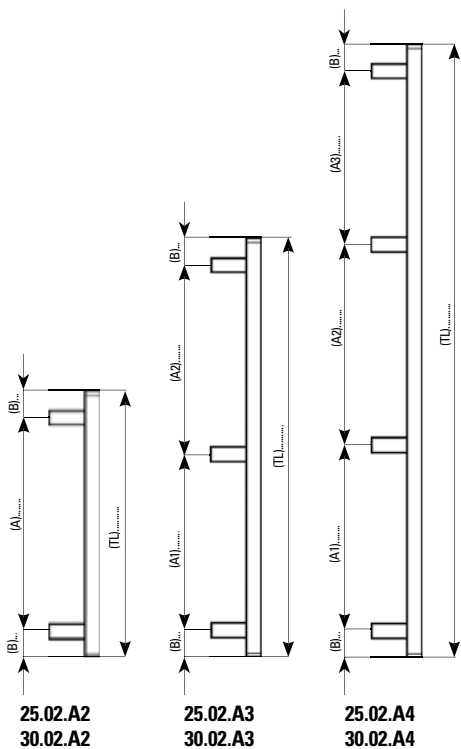

- È necessario, da parte del cliente, indicare le quote (TL)...lunghezza totale, B) ...sporgenza, (A)...interasse
- It is necessary from the customer to indicate the following measures (TL)...Total lenght, (A)...Axe center to center
- Es ist notwendig folgende Maßen anzugeben (TL)...Länge, (A)...Achsabstand

- ESEMPIO CALCOLO INTERASSE
- EXAMPLE AXE CALCULATION
- BEISPIEL ACHSABSTAND BERECHNUNG

TL: 2500
B: 150
A: 3

$2500 - (150 \times 2) = 2200$
 $2200 : 3 = 733$

POS.	PROD.	Q.TÀ	FIN.	EURO	PROD.	Q.TÀ	FIN.	EURO
------	-------	------	------	------	-------	------	------	------

MANIGLIONI DUOLOCK

IN ACCIAIO INOX CON SERRATURA INCORPORATA
PULLHANDLES WITH LOCK IN STAINLESS STEEL
VERSPERBARER STOSSGRIFFE AUS EDESTAHL

▶ INDOOR 163

F. 65

- Chiave-pomolo
- Key/knob
- Schlüssel/Dreh-knopf

- Lavorazione vetro
- Glass preparation
- Glasbearbeitung

35.DL.13/1125.1500 1 pair IX **546,00 /pair**

- Chiave-chiave
- Key/key
- Schlüssel/Schlüssel

- Lavorazione vetro
- Glass preparation
- Glasbearbeitung

35.DLC.13/1125.1500 1 pair IX **615,00 /pair**

F. 66		DL.LEGNO SET	1 pc	94,50 /pc
F. 67		EX-STESSA-CH-DL	1 pc	169,30 /pc

POS.	PROD.	Q.TÀ	FIN.	EURO	PROD.	Q.TÀ	FIN.	EURO
------	-------	------	------	------	-------	------	------	------

MANIGLIONI DUOLOCK H
IN ACCIAIO INOX - 2200 MM CON SERRATURA INCORPORATA ALTO/BASSO
PULLHANDLES IN STAINLESS STEEL LENGTH 2200 MMM WITH TOP/BOTTOM LOCKING
VERSPERBARER STOSSGRIFFE AUS EDESTAHL LÄNGE 2200 MM.
OBEN/UNTEN VERSPERRBAR

▶ INDOOR 163

F. 68

- Chiave-pomolo
- Key/knob
- Schlüssel/Dreh-knopf

- Lavorazione vetro
- Glass preparation
- Glasbearbeitung

- Chiave-chiave
- Key/key
- Schlüssel/Schlüssel

- Lavorazione vetro
- Glass preparation
- Glasbearbeitung

35.HD.13/1125.2200	1 pair	IX	888,70 /pair
---------------------------	--------	----	---------------------

35.HDC.13/1125.2200	1 pair	IX	1227,00 /pair
----------------------------	--------	----	----------------------

F. 69

DL-01	1 pc	232,50 /pc
--------------	------	-------------------

F. 70

DL-02	1 pc	354,30 /pc
--------------	------	-------------------

POS.	PROD	ART.	Q.TÀ	FIN.	EURO	FIN.	EURO
MANIGLIONI ANTIPANICO <i>PANIC EXIT DEVICES / PANIK STOSSGRIFFE</i>		▶ INDOOR 164					
F. 71		A-100	1 pc	RAL 7040 GREY	316,00 /set	NS	649,30 /set
F. 72		A-101	1 kit	IX	188,70 /kit		
F. 73		A-102	1 pc	RAL 7040 GREY	161,30 /pc	NS	291,50 /pc
F. 74		A-103	1 kit	IX	188,70 /kit		
F. 75		A-104	1 kit	RAL 7040 GREY	333,00 /kit	NS	731,50 /kit
F. 76		A-105	1 kit	RAL 7040 GREY	360,50 /kit	NS	797,30 /kit
F. 77		A-106	1 kit	IX	185,30 /kit		
F. 78		A-107	1 set	IX	135,30 /set		
F. 78.1		A-108	1 pc	RAL 7040 GREY	87,30 /pc	IX	179,30 /pc
F. 79		A-109	1 pc	NO	642,00 /pc		
F. 80		A-110	1 kit	RAL 7040 GREY	255,50 /kit	NS	329,70 /kit

F. 81

SET MANIGLIONI ANTIPANICO
PANIC EXIT DEVICES / PANIK STOSSGRIFFE

▶ INDOOR 164

Anti-Set 1

MOBILE PIVOT DOOR DREHTÜR

NS	€ 1129,30
RAL 7040	€ 665,70

100-101-102

Anti-Set 2

MOBILE PIVOT DOOR DREHTÜR

NS	€ 2046,00
RAL 7040	€ 1183,70

100-101-102-104-106

Anti-Set 3

MOBILE PIVOT DOOR DREHTÜR

NS	€ 2046,00
RAL 7040	€ 1183,70

100-101-102-104-106

Anti-Set 4

MOBILE PIVOT DOOR DREHTÜR

NS	€ 2111,70
RAL 7040	€ 1211,30

100-101-102-105-106

Anti-Set 5

MOBILE PIVOT DOOR DREHTÜR

NS	€ 2111,70
RAL 7040	€ 1211,30

100-101-102-105-106

Anti-Set 6

SOPRALUCE OVERPANEL OBERLICHT

MOBILE PIVOT DOOR DREHTÜR

NS	€ 1129,30
RAL 7040	€ 665,70

100-101-102

Anti-Set 7

SOPRALUCE OVERPANEL OBERLICHT

MOBILE PIVOT DOOR DREHTÜR

NS	€ 2181,00
RAL 7040	€ 1319,00

100-101-102-104-106-107

Anti-Set 8

SOPRALUCE OVERPANEL OBERLICHT

MOBILE PIVOT DOOR DREHTÜR

NS	€ 2181,00
RAL 7040	€ 1319,00

100-101-102-104-106-107

Anti-Set 9

SOPRALUCE OVERPANEL OBERLICHT

MOBILE PIVOT DOOR DREHTÜR

NS	€ 2111,70
RAL 7040	€ 1211,30

100-101-102-105-106

Anti-Set 10

SOPRALUCE OVERPANEL OBERLICHT

MOBILE PIVOT DOOR DREHTÜR

NS	€ 2111,70
RAL 7040	€ 1211,30

100-101-102-105-106

Anti-Set 11

MOBILE PIVOT DOOR DREHTÜR

FISSO FIXED SEITENTEIL

NS	€ 1264,50
RAL 7040	€ 801,00

100-101-102-107

Anti-Set 12

MOBILE PIVOT DOOR DREHTÜR

FISSO FIXED SEITENTEIL

NS	€ 2181,00
RAL 7040	€ 1319,00

100-101-102-104-106-107

Anti-Set 13

MOBILE PIVOT DOOR DREHTÜR

FISSO FIXED SEITENTEIL

NS	€ 2046,00
RAL 7040	€ 1183,70

100-101-102-104-106

Anti-Set 14

MOBILE PIVOT DOOR DREHTÜR

FISSO FIXED SEITENTEIL

NS	€ 2517,00
RAL 7040	€ 1617,00

100-101-102-105-106-3x107

Anti-Set 15

MOBILE PIVOT DOOR DREHTÜR

FISSO FIXED SEITENTEIL

NS	€ 2382,00
RAL 7040	€ 1481,70

100-101-102-105-106-2x107

Anti-Set 16

SOPRALUCE OVERPANEL OBERLICHT

MOBILE PIVOT DOOR DREHTÜR

FISSO FIXED SEITENTEIL

NS	€ 1264,50
RAL 7040	€ 801,00

100-101-102-107

Anti-Set 17

SOPRALUCE OVERPANEL OBERLICHT

MOBILE PIVOT DOOR DREHTÜR

FISSO FIXED SEITENTEIL

NS	€ 2316,30
RAL 7040	€ 1454,00

100-101-102-104-106-2x107

Anti-Set 18

SOPRALUCE OVERPANEL OBERLICHT

MOBILE PIVOT DOOR DREHTÜR

FISSO FIXED SEITENTEIL

NS	€ 2181,00
RAL 7040	€ 1319,00

100-101-102-104-106-107

Anti-Set 19

SOPRALUCE OVERPANEL OBERLICHT

MOBILE PIVOT DOOR DREHTÜR

FISSO FIXED SEITENTEIL

NS	€ 2517,00
RAL 7040	€ 1617,00

100-101-102-105-106-3x107

Anti-Set 20

SOPRALUCE OVERPANEL OBERLICHT

MOBILE PIVOT DOOR DREHTÜR

FISSO FIXED SEITENTEIL

NS	€ 2382,00
RAL 7040	€ 1481,70

100-101-102-105-106-2x107

Anti-Set 21

FISSO FIXED SEITENTEIL

MOBILE PIVOT DOOR DREHTÜR

MOBILE PIVOT DOOR DREHTÜR

FISSO FIXED SEITENTEIL

NS	€ 3800,30
RAL 7040	€ 2361,00

2x100-101-102-103-2x104-2x106

Anti-Set 22

SOPRALUCE OVERPANEL OBERLICHT

MOBILE PIVOT DOOR DREHTÜR

MOBILE PIVOT DOOR DREHTÜR

FISSO FIXED SEITENTEIL

FISSO FIXED SEITENTEIL







NS	€ 4070,50
RAL 7040	€ 2476,70

2x100-101-102-103-2x104-2x106-2x107

- Confezioni industriali
- Industrial packaging
- Industrieverpackungen

min

- Prezzi speciali per l'acquisto delle quantità minime indicate dell'articolo
- NB eventuali riordini o aggiunte per completamenti se di quantità inferiore alla minima, saranno fatturati al prezzo normale
- Special prices for the purchase of the minimum quantities indicated of the article
- Note Well: any reorders or additions for completions of quantity less than the minimum will be invoiced at the normal price
- Artikel mit Sonderpreisen bei Mindestabnahmemengen sind mit gekennzeichnet
- Nachbestellungen oder Ergänzungen unter der Mindestabnahmemenge werden mit dem Normalpreis verrechnet

POS.	PROD	ART.	Q.TÀ	FIN.	EURO	FIN.	EURO	FIN.	EURO		
NICCHIE PER SCORREVOLI											
<i>SLIDING HANDLES / GRIFFMUSCHEL</i>											
▶ INDOOR 168											
F. 82		V-506	1 pair	CS	86,00 /pair	NS	88,70 /pair	CR	93,70 /pair		
				CP	88,70 /pair	GR	76,00 /pair				
		V-506	■ min 10 pairs	CS	66,30 /pair	NS	69,30 /pair	CR	77,50 /pair		
				CP	69,30 /pair	GR	55,30 /pair				
F. 83	 60x90 mm	V-510	1 pair	CS	81,00 /pair	NS	81,00 /pair	CR	92,70 /pair		
				CP	81,00 /pair						
		V-510	■ min 10 pairs	CS	66,30 /pair	NS	66,30 /pair				
				CP	66,30 /pair						
F. 84	 60x90 mm	V-511	1 pair	CS	91,50 /pair	NS	91,50 /pair	CR	103,30 /pair		
				CP	91,50 /pair	NO	100,30 /pair				
		V-511	■ min 10 pairs	CS	83,00 /pair	NS	83,00 /pair				
				CP	83,00 /pair	NO	91,50 /pair				
F. 85	 60x110 mm	V-511-INC	1 pair	OL	143,30 /pair						
F. 86	 ∅65 mm	V-522	1 pair	AN	75,00 /pair	NS	76,00 /pair	CR	91,50 /pair		
		V-522	■ min 10 pairs	AN	55,70 /pair	NS	57,00 /pair	CR	81,00 /pair		
F. 87		V-406-R	1 pair	AN	94,50 /pair	NS	97,00 /pair	GR	90,00 /pair		
		V-406-R	■ min 10 pairs	AN	81,00 /pair	NS	83,00 /pair	NS	78,50 /pair		

POS.	PROD	ART.	Q.TÀ	FIN.	EURO	FIN.	EURO	FIN.	EURO
F. 88		V-406	1 pair	NS	94,50 /pair	CR	98,00 /pair	CP	94,50 /pair
		V-406	■ min 10 pairs	NS	81,00 /pair	CR	87,30 /pair	CP	81,00 /pair
F. 89		V-512-INC	1 pc	AN	45,30 /pc	NS	46,30 /pc		
		V-512-INC	■ min 10 pcs	AN	30,30 /pc	NS	31,30 /pc		
F. 90		V-522-INC	1 pc	AN	51,00 /pc	NS	52,30 /pc		
		V-522-INC	■ min 10 pcs	AN	36,00 /pc	NS	37,00 /pc		
F. 91		V-533-INC	1 pc	AN	46,70 /pc	NS	47,70 /pc		
		V-533-INC	■ min 10 pcs	AN	32,00 /pc	NS	33,00 /pc		
F. 92		V-534-INC	1 pc	CS	74,00 /pc	NS	74,00 /pc	CR	76,00 /pc
				OL	94,50 /pc				
		V-534-INC	■ min 10 pcs	CS	56,50 /pc	NS	56,50 /pc	CR	59,00 /pc
				OL	88,70 /pc				
F. 92.1		V-532-INC	1 pc	AN	40,30 /pc	NS	41,50 /pc		
		V-532-INC	■ min 10 pcs	AN	25,30 /pc	NS	26,30 /pc		

- Confezioni industriali
- Industrial packaging
- Industrieverpackungen

- min
- Prezzi speciali per l'acquisto delle quantità minime indicate dell'articolo
NB eventuali riordini o aggiunte per completamenti se di quantità inferiore alla minima, saranno fatturati al prezzo normale
- Special prices for the purchase of the minimum quantities indicated of the article
Note Well: any reorders or additions for completions of quantity less than the minimum will be invoiced at the normal price
- Artikel mit Sonderpreisen bei Mindestabnahmemengen sind mit gekennzeichnet
Nachbestellungen oder Ergänzungen unter der Mindestabnahmemenge werden mit dem Normalpreis verrechnet

POS.	PROD	ART.	Q.TÀ	FIN.	EURO	FIN.	EURO	FIN.	EURO
F. 93	 Ø65 mm	V-512	1 pair	AN	54,70 /pair	CS	56,50 /pair	NS	56,50 /pair
				CR	70,30 /pair	OL	107,50 /pair	NO	87,30 /pair
		V-512	■ min 10 pairs	AN	39,70 /pair	CS	41,50 /pair	NS	41,50 /pair
				CR	51,00 /pair			NO	70,50 /pair
F. 94	 Ø55 mm	V-523	1 pair	AN	63,30 /pair	NS	79,50 /pair	CR	110,00 /pair
F. 95	 Ø59mm	V-524	1 pair	CP	60,00 /pair	NS	60,00 /pair	CR	55,70 /pair
		V-524	■ min 10 pairs	CP	47,50 /pair	NS	47,50 /pair	CR	44,70 /pair
F. 96	 Ø40 mm	V-525	1 pair	AN	54,70 /pair	NS	54,30 /pair	CR	52,50 /pair
		V-525	■ min 10 pairs	AN	42,50 /pair	NS	42,00 /pair	CR	40,30 /pair
F. 97	 Ø40 mm	V-526	1 pair	AN	56,50 /pair	NS	55,70 /pair	CR	54,30 /pair
		V-526	■ min 10 pairs	AN	44,00 /pair	NS	43,50 /pair	CR	42,00 /pair
F. 98	 Ø30 mm	V-527	1 pair	AN	45,30 /pair	NS	50,00 /pair	CR	50,00 /pair

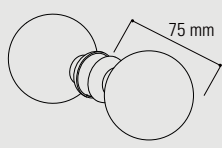
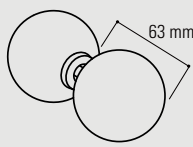
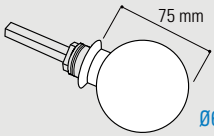
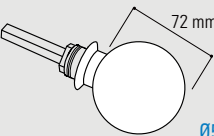
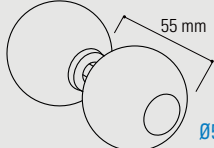
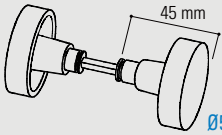
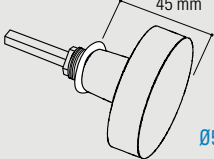
POS.	PROD	ART.	Q.TÀ	FIN.	EURO	FIN.	EURO	FIN.	EURO
F. 99	 Ø30 mm	V-528	1 pair	AN	45,30 /pair	NS	50,70 /pair	CR	50,70 /pair
POMOLI PER VETRO KNOBS / KNÖPFE ▶ INDOOR 174									
F. 100	 75 mm Ø60 mm	V-1056	1 pair	CS	117,50 /pair	NS	117,50 /pair	CR	127,70 /pair
				OL	127,70 /pair	CP	117,50 /pair		
<ul style="list-style-type: none"> • Non disponibili versione girevole • Not available in the turnable version • Drehbare Version nicht verfügbar 									
F. 101	 63 mm Ø50 mm	V-1056 2	1 pair	CS	115,00 /pair	NS	115,00 /pair	CR	125,00 /pair
				OL	125,00 /pair	CP	115,00 /pair		
<ul style="list-style-type: none"> • Non disponibili versione girevole • Not available in the turnable version • Drehbare Version nicht verfügbar 									
F. 102	 75 mm Ø60 mm	V-1056-WE	1 pc	CS	129,00 /pc	NS	129,00 /pc	CR	140,70 /pc
				OL	140,70 /pc	CP	129,00 /pc		
F. 103	 72 mm Ø50 mm	V-1056 D50-WE	1 pc	CS	126,30 /pc	NS	126,30 /pc	CR	138,30 /pc
				OL	138,30 /pc	CP	126,30 /pc		
F. 104	 55 mm Ø50 mm	V-013	1 pair	CS	140,70 /pair	NS	140,70 /pair	CR	140,70 /pair
				OL	140,70 /pair	CP	140,70 /pair		
F. 105	 45 mm Ø55 mm	V-1105	1 pair	CS	169,30 /pair	NS	169,30 /pair	CR	179,70 /pair
				OL	179,70 /pair	CP	169,30 /pair		
F. 106	 45 mm Ø55 mm	V-1105-WE	1 pc	CS	169,30 /pc	NS	169,30 /pc	CR	179,70 /pc
				OL	179,70 /pc	CP	169,30 /pc		

- Confezioni industriali
- Industrial packaging
- Industrieverpackungen

min

- Prezzi speciali per l'acquisto delle quantità minime indicate dell'articolo
- NB eventuali riordini o aggiunte per completamenti se di quantità inferiore alla minima, saranno fatturati al prezzo normale
- Special prices for the purchase of the minimum quantities indicated of the article
- Note Well: any reorders or additions for completions of quantity less than the minimum will be invoiced at the normal price
- Artikel mit Sonderpreisen bei Mindestabnahmemengen sind mit gekennzeichnet
- Nachbestellungen oder Ergänzungen unter der Mindestabnahmemenge werden mit dem Normalpreis verrechnet

POS.	PROD	ART.	Q.TÀ	FIN.	EURO	FIN.	EURO	FIN.	EURO
F. 107		Ø 40 mm S 52 mm	1 pair	NS	111,30 /pair				
		Ø 45 mm S 57 mm	1 pair	NS	126,70 /pair				
		Ø 50 mm S 62 mm	1 pair	NS	142,30 /pair				
F. 108		V-024 25	1 pair	CR	37,00 /pair				
				NS	37,00 /pair				
F. 109		V-024 30	1 pair	CR	37,70 /pair	NS	37,70 /pair		
				■ min 10 pairs	CR	30,50 /pair	NS	30,50 /pair	
F. 110		V-024 32	1 pair	CR	48,30 /pair	NS	48,30 /pair		
				■ min 10 pairs	CR	41,50 /pair	NS	41,50 /pair	
F. 111		V-024 38	1 pair	CR	69,70 /pair				
				NS	64,70 /pair				
F. 112		B-168	1 pair	CR	29,50 /pair	NS	29,50 /pair	CP	29,50 /pair
				NO	41,30 /pair				
				■ min 10 pairs	CR	23,00 /pair	NS	23,00 /pair	CP
				NO	32,00 /pair				
F. 113		B-169	1 pair	CR	51,00 /pair				
				■ min 10 pairs	CR	43,50 /pair			

POS.	PROD	ART.	Q.TÀ	FIN.	EURO	FIN.	EURO	FIN.	EURO
F. 114		B-177	1 pair	IL	69,70 /pair	IX	69,70 /pair		
		B-177	■ min 10 pairs	IL	59,50 /pair	IX	59,50 /pair		
F. 115		B-178	1 pair	CR	88,70 /pair	NS	88,70 /pair		
		B-178	■ min 10 pairs	CR	68,30 /pair	NS	68,30 /pair		
F. 116		B-194	1 pair	CR	45,30 /pair	NS	45,30 /pair		
		B-194	■ min 10 pairs	CR	38,70 /pair	NS	38,70 /pair		
F. 117		B-195	1 pair	CR	51,00 /pair	NS	51,00 /pair		
		B-195	■ min 10 pairs	CR	43,50 /pair	NS	43,50 /pair		
F. 118		V-1107	1 pair	CR	42,50 /pair				
		V-1107	■ min 10 pairs	CR	36,50 /pair				
F. 119		POR-153V	1 pair	NS	58,30 /pair				
				CR	51,00 /pair				

- Confezioni industriali
- Industrial packaging
- Industrieverpackungen

■ **min**

- Prezzi speciali per l'acquisto delle quantità minime indicate dell'articolo
NB eventuali riordini o aggiunte per completamenti se di quantità inferiore alla minima, saranno fatturati al prezzo normale
- Special prices for the purchase of the minimum quantities indicated of the article
Note Well: any reorders or additions for completions of quantity less than the minimum will be invoiced at the normal price
- Artikel mit Sonderpreisen bei Mindestabnahmemengen sind mit gekennzeichnet
Nachbestellungen oder Ergänzungen unter der Mindestabnahmemenge werden mit dem Normalpreis verrechnet

POS.	PROD	ART.	Q.TÀ	FIN.	EURO	FIN.	EURO	FIN.	EURO
F. 121		B-179	1 pc	CS	88,00 /pc				
				CR	88,00 /pc				
F. 122		B-180	1 pc	CS	64,50 /pc				
				CR	64,50 /pc				
F. 124		B-191-80	1 pc	CR	62,30 /pc				
		B-191-240	1 pc	CR	71,50 /pc				
F. 125		B-192	1 pc	CR	55,30 /pc				
F. 126		B-193	1 pc	CR	79,30 /pc				
F. 127		B-197	1 pair	CR	95,50 /pair				
		B-197	■ min 10 pairs	CR	83,30 /pair				

GUIDA TECNICA PER LA SCELTA DEL VOSTRO SISTEMA
TECHNICAL GUIDE FOR THE CHOICE OF YOUR SYSTEM
AUSWAHL VON DUSCHKABINEN NACH VORHANDENEN KRITERIEN

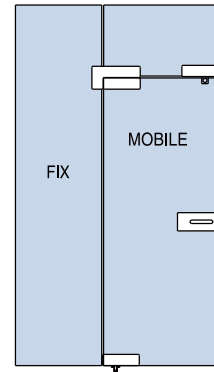
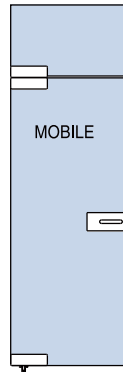
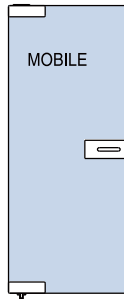

HYDRAULIC
LAM-H1006
LAM-H1007
V-H1012



▶ 432
▶ 432
▶ 433



HYDRAULIC
LAM-H1006
LAM-H1007
V-H1012



▶ 432
▶ 432
▶ 433



HYDRAULIC
LAM-H1006
LAM-H1007
V-H1012



▶ 432
▶ 432
▶ 433

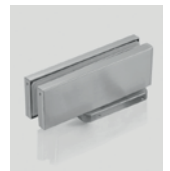

X SERIE
XC-020
XC-010

▶ 440
▶ 440



X SERIE
XCS-020B
XC-020
XC-010

▶ 440
▶ 440
▶ 440



X SERIE
XC-040
XC-020
X-480B
XC-010

▶ 440
▶ 440
▶ 441
▶ 440



X SERIE MINI
XD-020
XD-040

▶ 443
▶ 443



X SERIE MINI
XDS-020B
XD-020
XD-040

▶ 443
▶ 443
▶ 443



MODULO QUADRO
MQ-6
MQ-11
MQ-14
MQ-2T

▶ 436
▶ 436
▶ 437
▶ 436



MODULO QUADRO
MQ-1
MQ-2T

▶ 436
▶ 436



MODULO QUADRO
MQ-13
MQ-11
MQ-2T

▶ 436
▶ 436
▶ 436



MODULO TONDO
M1-SET
M13
M2-T

▶ 440
▶ 439
▶ 438



MODULO TONDO
M1
M2-T

▶ 438
▶ 438



MODULO TONDO
M11-L/R
M1
M-2T

▶ 439
▶ 438
▶ 438



MODULO QUADRO PER FORTI SPESSORI
HINGES FOR GLASS THICKNESS
BÄNDER FÜR GLASDICKE 17,5 - 21,5 mm

MQFS-2T
MQFS-1

▶ 434
▶ 434



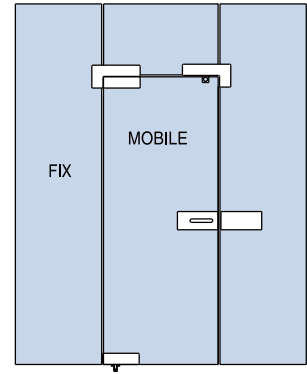
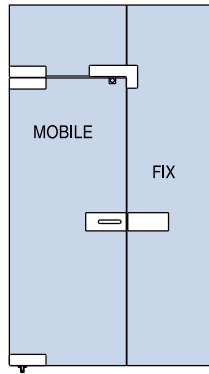
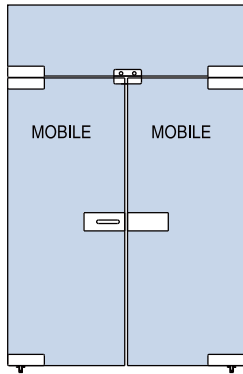

HYDRAULIC
LAM-H1006
LAM-H1007
V-H1012

▶ 432
▶ 432
▶ 433



HYDRAULIC
LAM-H1006
LAM-H1007
V-H1012

▶ 432
▶ 432
▶ 433



HYDRAULIC
LAM-H1006
LAM-H1007
V-H1012

▶ 432
▶ 432
▶ 433



X SERIE
XCS-020B
XC-020
X-480B
XC-010

▶ 440
▶ 440
▶ 441
▶ 440



X SERIE
XCS-020B
XC-020
X-470B
XC-010

▶ 440
▶ 440
▶ 441
▶ 440



X SERIE
XCS-020B
XC-020
X-470B
XC-010

▶ 440
▶ 440
▶ 441
▶ 440



**X SERIE
MINI**
XDS-020B
XD-020
X-480B
XD-040

▶ 443
▶ 443
▶ 443
▶ 443



**MODULO
QUADRO**
MQ-13
MQ-11
MQ-17
MQ-2T

▶ 436
▶ 436
▶ 438
▶ 436



**MODULO
QUADRO**
MQ-13
MQ-11
MQ-17
MQ-2T

▶ 436
▶ 436
▶ 438
▶ 436



**MODULO
QUADRO
TONDO**
MQ-13
MQ-11
MQ-17
MQ-2T

▶ 436
▶ 436
▶ 438
▶ 436



**MODULO
TONDO**
M11-L/R
M1
M14
M2-T

▶ 439
▶ 438
▶ 439
▶ 438



**MODULO
TONDO**
M1-SET
M13
M2-T

▶ 440
▶ 439
▶ 438



**MODULO
TONDO**
M11-L/R
M1
M13
M2-T

▶ 439
▶ 438
▶ 439
▶ 438



ACCESSORI
ACCESSORIES
ZUBEHÖRE

**SERRATURE PER FORTI SPESSORI
LOCKS FOR GLASS THICKNESS
SCHLÖSSER FÜR GLASDICKE 17,5 - 21,5 mm**

ELEGANT FS ▶ 435



SERIE "ANTIK LINE"

**SERRATURE, CERNIERE E MANIGLIONI
LOCKS, HINGES AND PULLHANDLES
SCHLÖSSER, BÄNDER UNS STOßGRIFFE**







▶ 444

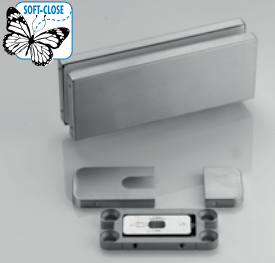
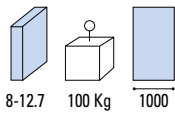

**CHIUDIPIORTA A PAVIMENTO
DOOR CLOSER
BODENTÜRSCHLIESSER**

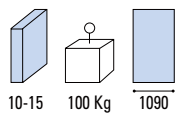
▶ 447

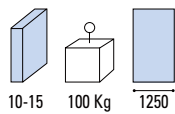

POS.	PROD.	ART.	MIS.	Q.TÀ	FIN.	EURO	FIN.	EURO	
CERNIERE INFERIORI OLEODINAMICHE <i>HYDRAULIC BOTTOM HINGES / HYDRAULISCHE UNTERE BÄNDER</i>									
OLEO ▶ INDOOR 182									
G. 1		LAM-H1006		1 pc	IX	338,50 /pc	AN	/pc	
				■ min 5 pcs	IX	326,00 /pc	AN	/pc	
				■ min 10 pcs	IX	298,50 /pc	AN	/pc	
G. 2		LAM-H1008		1 pc	IX	68,30 /pc	AN	/pc	
				■ min 5 pcs	IX	56,50 /pc	AN	/pc	
				■ min 10 pcs	IX	43,50 /pc	AN	/pc	
G. 3		LAM-H1000		1 pc	IX	15,30 /pc	AN	/pc	
				■ min 5 pcs	IX	13,50 /pc	AN	/pc	
				■ min 10 pcs	IX	11,30 /pc	AN	/pc	
G. 4		SET OLEO 01		1 set	IX	421,30 /set	AN	/set	
				SET OLEO 05	■ min 5 sets	IX	395,50 /set	AN	/set
					SET OLEO 10	■ min 10 sets	IX	353,00 /set	AN
LAM-H1007									
G. 5		LAM-H1007		1 pc	IX	595,30 /pc	AN	/pc	
				■ min 5 pcs	IX	530,00 /pc	AN	/pc	
				■ min 10 pcs	IX	486,70 /pc	AN	/pc	

- Confezioni industriali
- Industrial packaging
- Industrieverpackungen

■ **min**

- Prezzi speciali per l'acquisto delle quantità minime indicate dell'articolo
NB eventuali riordini o aggiunte per completamenti se di quantità inferiore alla minima, saranno fatturati al prezzo normale
- Special prices for the purchase of the minimum quantities indicated of the article
Note Well: any reorders or additions for completions of quantity less than the minimum will be invoiced at the normal price
- Artikel mit Sonderpreisen bei Mindestabnahmemengen sind mit gekennzeichnet
Nachbestellungen oder Ergänzungen unter der Mindestabnahmemenge werden mit dem Normalpreis verrechnet

POS.	PROD.	ART.	MIS.	Q.TÀ	FIN.	EURO	FIN.	EURO
184	OLLY							▶ INDOOR 184
G. 6		V-H1012		1 pc	IX	281,30 /pc		
				■ min 5 pcs	IX	259,50 /pc		
				■ min 10 pcs	IX	206,70 /pc		
G. 7		V-H1013		1 pc	IX	83,00 /pc		
				■ min 5 pcs	IX	70,30 /pc		
				■ min 10 pcs	IX	54,30 /pc		
G. 8		SET V-H1012 01		1 set	IX	364,00 /set		
		SET V-H1012 05	■ min 5 sets	IX	329,70 /set			
		SET V-H1012 10	■ min 10 sets	IX	260,50 /set			

POS.	PROD.	ART.	MIS.	Q.TÀ	FIN.	EURO	FIN.	EURO
MODULO QUADRO PER FORTI SPESSORI 17,5 - 21,5 mm <i>"MODULO QUADRO" FOR GLASS THICKNESS 17,5 - 21,5 mm</i> <i>MODULO QUADRO" FÜR GLASDICKE 17,5 - 21,5 mm</i> ▶ INDOOR 186								
G. 9		MQFS-2T	Per vetro / For glass / Für Glas 17,5 - 21,5 mm	1 pc	IX	229,30 /pc	IL	229,30 /pc
		MQFS-2T	Per vetro / For glass / Für Glas 17,5 - 21,5 mm	■ min 10 pcs	IX	189,30 /pc	IL	189,30 /pc
G. 10		MQFS-1	Per vetro / For glass / Für Glas 17,5 - 21,5 mm	1 pc	IX	233,30 /pc	IL	233,30 /pc
		MQFS-1	Per vetro / For glass / Für Glas 17,5 - 21,5 mm	■ min 10 pcs	IX	190,50 /pc	IL	190,50 /pc
G. 11		MQFS-7		1 pc	IX	32,50 /pc		
		MQFS-7		■ min 10 pcs	IX	18,50 /pc		
G. 12		XT-83 B		1 pc	IX	41,50 /pc		
ELEGANT LEVER FS ▶ INDOOR 188								
G. 13		V-745-13,5 PZ	Per vetro / For glass / Für Glas 13,5 - 17,5 - 21,5 mm	1 pc	NS	260,30 /pc	CR	266,30 /pc
		V-745-17,5 PZ						
		V-745-21,5 PZ						
G. 14		V-745-13,5 2FLG	Per vetro / For glass / Für Glas 13,5 - 17,5 - 21,5 mm	1 pc	NS	248,70 /pc	CR	253,50 /pc
		V-745-17,5 2FLG						
		V-745-21,5 2FLG						

- Confezioni industriali
- Industrial packaging
- Industrieverpackungen

■ **min**

- Prezzi speciali per l'acquisto delle quantità minime indicate dell'articolo
NB eventuali riordini o aggiunte per completamenti se di quantità inferiore alla minima, saranno fatturati al prezzo normale
- Special prices for the purchase of the minimum quantities indicated of the article
Note Well: any reorders or additions for completions of quantity less than the minimum will be invoiced at the normal price
- Artikel mit Sonderpreisen bei Mindestabnahmemengen sind mit gekennzeichnet
Nachbestellungen oder Ergänzungen unter der Mindestabnahmemenge werden mit dem Normalpreis verrechnet

POS.	PROD.	ART.	MIS.	Q.TÀ	FIN.	EURO	FIN.	EURO
G. 15		V-023		1 pc	NS	36,70 /pc		
G. 16		C-024	70 mm	1 pc		47,70 /pc		





ELEGANT FS

► INDOOR 189





G. 17		V-725-13,5 PZ	Per vetro / For glass / Für Glas 13,5 - 17,5 - 21,5 mm	1 pc	NS	211,00 /pc	CR	215,50 /pc
		V-725-17,5 PZ						
		V-725-21,5 PZ						
G. 18		V-725-13,5 2FLG	Per vetro / For glass / Für Glas 13,5 - 17,5 - 21,5 mm	1 pc	NS	203,70 /pc	CR	208,30 /pc
		V-725-17,5 2FLG						
		V-725-21,5 2FLG						
G. 19		V-023		1 pc	NS	36,70 /pc		
G. 20		C-06	45 mm	1 pc	CR	29,70 /pc		

POS.	PROD.	ART.	Q.TÀ	FIN.	EURO	FIN.	EURO	FIN.	EURO
MODULO QUADRO									▶ INDOOR 190
G. 21		MQ-1	1 pc	NS	144,30 /pc	CR	181,00 /pc		
G. 22		MQ-2 I	1 pc	NS	152,50 /pc	CR	187,30 /pc		
G. 23		MQ-2 T	1 pc	NS	152,50 /pc	CR	187,30 /pc		
G. 24		MQ-11	1 pc	NS	129,00 /pc	CR	165,50 /pc		
G. 25		MQ-12 T	1 pc	NS	125,30 /pc	CR	160,30 /pc		
G. 26		MQ-12 I	1 pc	NS	129,00 /pc	CR	165,50 /pc		
G. 27		MQ-13	1 pc	NS	152,50 /pc	CR	188,00 /pc		
G. 28		MQ-6	1 pc	NS	188,00 /pc	CR	226,30 /pc		





POS.	PROD.	ART.	Q.TÀ	FIN.	EURO	FIN.	EURO	FIN.	EURO
G. 29		MQ-4	1 pc	NS	211,00 /pc	CR	248,70 /pc		
G. 30		MQ-8	1 pc	NS	211,00 /pc	CR	248,70 /pc		
G. 31		MQ-14	1 pc	NS	174,30 /pc	CR	211,00 /pc		
G. 32		MQ-16	1 pc	NS	174,30 /pc	CR	211,00 /pc		
G. 33		MQ-3	1 pc	NS	59,50 /pc				
G. 34		MQ-5	1 pc	NS	81,70 /pc	CR	97,30 /pc		
G. 35		MQ-7	1 pc		21,30 /pc				
G. 36		V-003-8	1 pc	NS	84,30 /pc	CR	87,70 /pc		
		V-003-10							
G. 37		MQ-9	1 pc	NS	22,00 /pc	CR	25,50 /pc	CP	24,50 /pc

POS.	PROD.	ART.	Q.TÀ	FIN.	EURO	FIN.	EURO	FIN.	EURO
G. 38		MQ-15	1 pc	NS	108,00 /pc	CR	134,30 /pc		
G. 39		MQ-10	1 pc	NS	90,00 /pc	CR	108,00 /pc		
G. 40		MQ-17	1 pc	NS	129,70 /pc	CR	153,70 /pc		
G. 41		XT-83B	1 pc		41,50 /pc				

MODULO TONDO ▶ INDOOR 196

G. 42		M-1	1 pc	NS	118,50 /pc				
G. 43		M-2 I	1 pc	NS	168,00 /pc				
G. 44		M-2 T	1 pc	NS	168,00 /pc				
G. 45		M-3	1 pc	NS	59,50 /pc				

POS.	PROD.	ART.	Q.TÀ	FIN.	EURO	FIN.	EURO	FIN.	EURO
G. 46		M-7	1 pc	NS	21,30 /pc				
G. 47		M-5	1 pc	NS	52,00 /pc				
G. 48		M-10	1 pc	NS	90,00 /pc				
G. 49		M-8	1 pc	NS	75,70 /pc				
G. 50		XT-83B	1 pc		41,50 /pc				
G. 51		M-9	1 pc	NS	76,70 /pc				
G. 52		M-13	1 pc	NS	129,70 /pc				
G. 53		M-14	1 pc	NS	134,30 /pc				
G. 54		M-15	1 pc	NS	117,00 /pc				
G. 55		M-11 R	1 pc	NS	142,70 /pc				
G. 56		M-11 L	1 pc	NS	142,70 /pc				

POS.	PROD.	ART.	Q.TÀ	FIN.	EURO	FIN.	EURO	FIN.	EURO
G. 57		M-12	1 pc	NS	142,70 /pc				
G. 58		M-16 R	1 pc	NS	440,50 /pc				
G. 59		M-16 L	1 pc	NS	440,50 /pc				
G. 60		M-1 SET	1 pc	NS	234,30 /pc				

SERIE "X" ▶ INDOOR 202

G. 61		XC-010	1 pc	IX	49,50 /pc	IL	49,50 /pc		
G. 62		XC-020	1 pc	IX	49,50 /pc	IL	49,50 /pc		
G. 63		XCS-020	1 pc	IX	49,50 /pc	IL	49,50 /pc		
G. 64		XCS-020B	1 pc	IX	59,50 /pc	IL	59,50 /pc		
G. 65		XC-040	1 pc	IX	75,70 /pc	IL	75,70 /pc		
G. 66		X-060 B	1 pc	IX	33,50 /pc	IL	33,50 /pc		

POS.	PROD.	ART.	Q.TÀ	FIN.	EURO	FIN.	EURO	FIN.	EURO
G. 67		X-080	1 pc	IX	35,30 /pc	IL	35,30 /pc		
G. 68		X-440	1 pc	IX	73,00 /pc	IL	73,00 /pc		
G. 69		X-470 B	1 pc	IX	75,00 /pc	IL	75,00 /pc		
G. 70		X-480 B	1 pc	IX	44,70 /pc	IL	44,70 /pc		
G. 71		X-400	1 pc	IX	214,70 /pc	IL	214,70 /pc		
G. 72		X-400 B	1 pc	IX	187,70 /pc	IL	187,70 /pc		
G. 73		X-420	1 pc	IX	187,70 /pc	IL	187,70 /pc		
G. 74		X-460	1 pc	IX	175,70 /pc	IL	175,70 /pc		
G. 75		X-450	1 pc	IX	175,70 /pc	IL	175,70 /pc		
G. 76		X-020	1 pc	IX	49,50 /pc	IL	49,50 /pc		
G. 77		X-410	1 pc	IX	126,30 /pc	IL	126,30 /pc		















POS.	PROD.	ART.	Q.TÀ	FIN.	EURO	FIN.	EURO	FIN.	EURO
G. 78		X-030 C	1 pc	IX	98,70 /pc	IL	98,70 /pc		
G. 79		X-030 E	1 pc	IX	52,00 /pc	IL	52,00 /pc		
G. 80		X-040 B	1 pc	IX	80,30 /pc	IL	80,30 /pc		
G. 81		X-133	1 pc	IX	103,30 /pc	IL	103,30 /pc		
G. 82		X-134	1 pc	IX	69,30 /pc	IL	69,30 /pc		
G. 83		X-090	1 pc	IX	42,50 /pc	IL	42,50 /pc		
G. 84		X-090 B	1 pc	IX	30,30 /pc	IL	30,30 /pc		
G. 85		X-317	1 pc	IX	180,70 /pc	IL	180,70 /pc		
G. 86		XT-83B	1 pc		41,50 /pc				

POS.	PROD.	ART.	Q.TÀ	FIN.	EURO	FIN.	EURO	FIN.	EURO
G. 87		XP-020	1 pc		14,30 /pc				
SERIE "X MINI"									► INDOOR 209
G. 88		XD-020	1 pc	AN	46,00 /pc	IL	46,00 /pc		
G. 89		XD-440	1 pc	AN	46,00 /pc	IL	46,00 /pc		
G. 90		XDS-020	1 pc	AN	47,00 /pc	IL	47,00 /pc		
G. 91		XDS-020B	1 pc	AN	47,00 /pc	IL	47,00 /pc		
G. 92		XD-040	1 pc	AN	74,00 /pc	IL	74,00 /pc		
G. 93		XD-030	1 pc	AN	81,30 /pc	IL	81,30 /pc		
G. 94		XD-030 B	1 pc	AN	52,00 /pc	IL	52,00 /pc		
G. 95		XT-83B	1 pc		41,50 /pc				
G. 96		XP-020	1 pc		14,30 /pc				

POS.	PROD.	ART.	Q.TÀ	FIN.	EURO
SERIE "ANTIK LINE"					▶ INDOOR 216
SERRATURE E CERNIERE <i>LOCKS AND HINGES / SCHLÖSSER UND BÄNDER</i>					
<ul style="list-style-type: none"> • Maniglie, cilindri e contropiastre da ordinare a parte • Handles, cylinders and strike plates not included, to order separately • Griffe, Zylinder und Schließbleche nicht enthalten, separat zu bestellen 					
G.97	 V-720 UV ANTIK	1 pc	Al /pc	BT /pc	NB /pc
G.98	 V-720 PZ ANTIK	1 pc	Al /pc	BT /pc	NB /pc
G.99	 C-04	1 pc	Al /pc	BT /pc	NB /pc
G.100	 V-745 PZ ANTIK	1 pc	Al /pc	BT /pc	NB /pc
G.101	 V-745 2FLG ANTIK	1 pc	Al /pc	BT /pc	NB /pc
G.102	 V-725 2FLG ANTIK	1 pc	Al /pc	BT /pc	NB /pc
G.103	 V-023	1 pc	Al /pc	BT /pc	NB /pc
G.104	 C-014	1 pc	Al /pc	BT /pc	NB /pc

POS.		PROD.		ART.	Q.TÀ	FIN.	EURO
G.105		V-509 ANTIK	1 pc	Al /pc	BT /pc	NB /pc	
G.106		V-402 ANTIK	1 pc	Al /pc	BT /pc	NB /pc	
G.107		LAM-H1006 ANTIK	1 pc	Al /pc	BT /pc	NB /pc	
G.108		LAM-H1008 ANTIK	1 pc	Al /pc	BT /pc	NB /pc	
G.109		XC-020 ANTIK	1 pc	Al /pc	BT /pc	NB /pc	
G.110		XC-010 ANTIK	1 pc	Al /pc	BT /pc	NB /pc	
G.111		XCS-020 ANTIK	1 pc	Al /pc	BT /pc	NB /pc	
G.112		XC-040 ANTIK	1 pc	Al /pc	BT /pc	NB /pc	

POS.		PROD.		ART.	Q.TÀ	FIN.	EURO
G.113		X-470 B ANTIK	1 pc	Al /pc	BT /pc	NB /pc	
G.114		X-480 B ANTIK	1 pc	Al /pc	BT /pc	NB /pc	
G.115		X-060 B ANTIK	1 pc	Al /pc	BT /pc	NB /pc	
G.116		X-080 ANTIK	1 pc	Al /pc	BT /pc	NB /pc	
<p>MANIGLIONI, POMOLI, MANIGLIE ANTIK <i>PULLHANDLES, KNOBS, DOORHANDLES / STOSSGRIFFE, KNOPFE, TÜRGRIF</i></p>							
<ul style="list-style-type: none"> • Per serratura in vetro, maniglia fornita senza rossette. • For glass locks, the handles are not supplied with washers. • Für Glasschloss wird Griff ohne Rosette geliefert. 							
G.117		16.41.03/260.315 ANTIK	1 pc	Al /pc	BT /pc	NB /pc	
G.118		V-110 ANTIK	1 pc	Al /pc	BT /pc	NB /pc	
G.119		V-1742 ANTIK	1 pc	Al /pc	BT /pc	NB /pc	

POS.	PROD.	ART.	Q.TÀ	FIN.	EURO
CHIUDIORTA A PAVIMENTO FLOOR SPRING / BODENTÜRSCHLIEßER ▶ INDOOR 222					
G. 120	   	FV-S4003	1 pc		267,30 /pc
G. 121	   	FV-S5003	1 pc		284,50 /pc
G. 122	   	FV-S6003	1 pc		288,70 /pc
G. 123	 	FV-PERNO-I	1 pc		43,00 /pc

- PAVIMENTO
- FLOOR INSTALLATION
- BODENMONTAGE

- PAVIMENTO LATERALE
- FLOOR INSTALLATION
- BODENMONTAGE

- INCASSATO
- RECESSED
- VERSENKT

- PAVIMENTO A PEZZI
- FLOOR INSTALLATION IN PIECES
- BODENMONTAGE IN TEILE

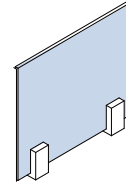
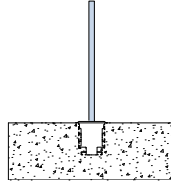
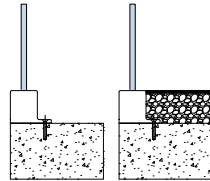
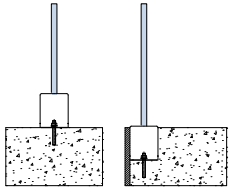

B-8000-WN
B-8000-WN-G

▶ 455

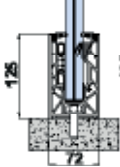

B-8300
B-8300-G

▶ 462

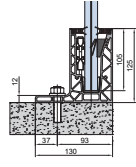

B-4050

▶ 462

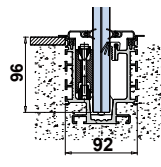

B-7500
B-7500-G

▶ 454

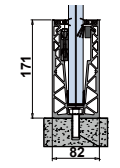

B-1101

▶ 461

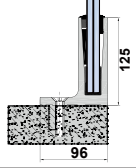

B-2060

▶ 462

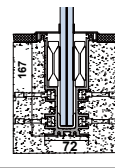

B-6000
B-6000-G

▶ 457

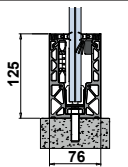

B-8700
B-8700-G

▶ 456

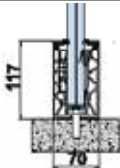

B-2100

▶ 459

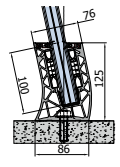

B-1100

▶ 461

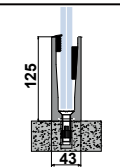

B-8500
B-8500-G

▶ 460

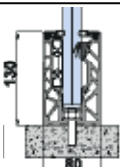

B-5500

▶ 461

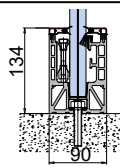

B-5600

▶ 461

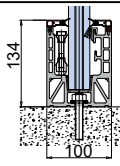

UNIBLOCK
UB-120

▶ 458 **NEW**

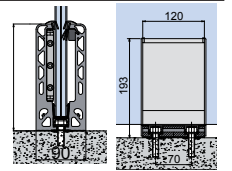

UNIBLOCK
UB-120 +
UB-122 ASTE

▶ 458 **NEW**

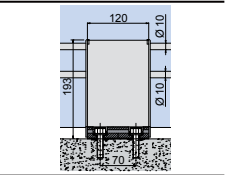

UNIBLOCK
UB-220

▶ 458 **NEW**

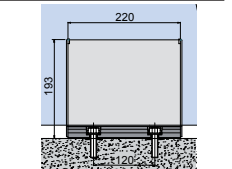

UNIBLOCK
UB-220 +
UB-122 ASTE

▶ 458 **NEW**

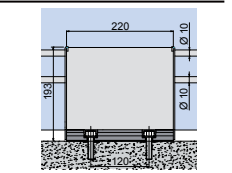

B-7520

▶ 454

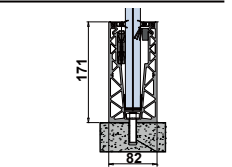

B-7120
B-7220

▶ 459

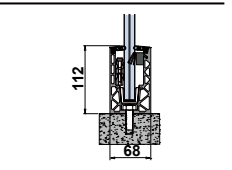

- PARAVENTO
- WINDSCREENS
- WINDSCHUTZSYSTEM

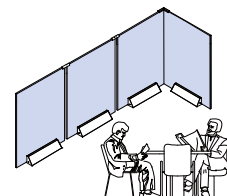

B-2800
B-2820
B-2860

▶ 494

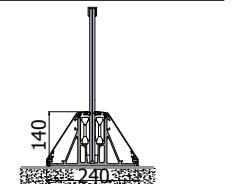

- ESTERNO
- SIDE INSTALLATION
- SEITENMONTAGE

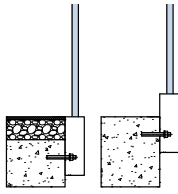

B-8250
B-8250-G

▶ 464

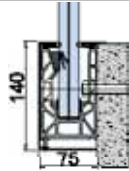

B-8260
B-8260-G

▶ 464

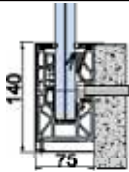

B-8200
B-8200-G

▶ 463

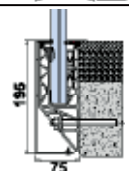

B-7550-G

▶ 463

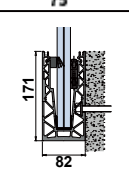

B-6220

▶ 465

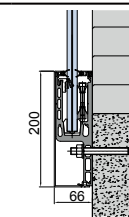

- SCALA
- STAIRS
- TREPPE

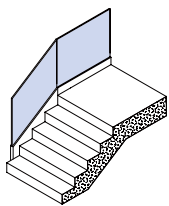

- MURETTO
- LOW WALL
- AUF ATTIKAMAUER

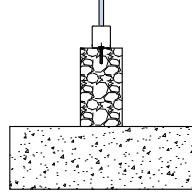

B-3500-N

▶ 466

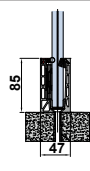

B-3600

▶ 465

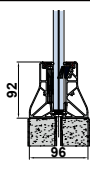

- COMPONENTI / ACCESSORI
- COMPONENTS / ACCESSORIES
- EINZELTEILE / ZUBEHÖRE



Profili di scolo
Drainage profiles
Drainageleisten
BWC-10 WATERCAP
BSA-WATER PROFILE

▶ 484

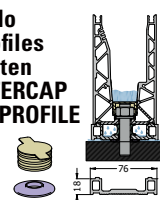

Ombrellino
Gasket "Umbrella"
Dichtung "Regenschirm"
B-4111-CF8
B-2009-10 / 20

▶ 483



Profili e velette
Profiles and
cover profiles
Profile und
Abdeckungen

▶ 467



Tappi finali
Endcaps
Endkappen

▶ 473

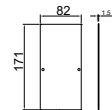

Morsetti Jolly Pack
Clamps Jolly Pack
Klemmbefestigungen
Jolly Pack

▶ 478

Kit morsetti e guarnizioni
Kit clamps and gaskets
Kit Klemmen und Dichtungen

▶ 474



Supporti vetro e guarnizioni
Support for glass and gaskets
Auflage für Glas und
Dichtungen

▶ 478 - 480

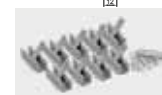

Accessori
Accessories
Zubehöre

▶ 483



- PENSILINE
- CANOPIES
- VORDÄCHER

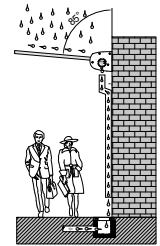

B-5040 KAMPIONA DRAIN

▶ 496

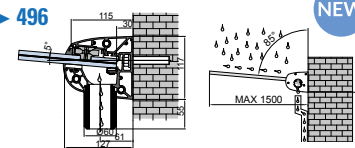

B-1040 KAMPIONA 110

▶ 499

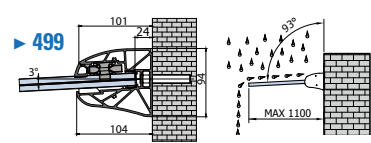

B-6040 KAMPIONA 150

▶ 499

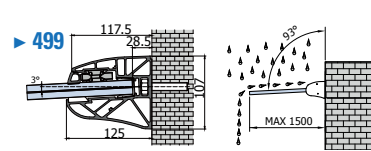

B-4040 MAXIMA

▶ 502

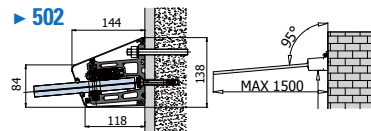

PRESA
PRESA 2

▶ 503

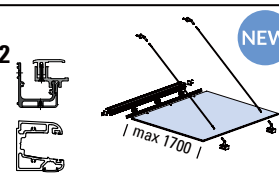

PROJECT FIVE

▶ 508

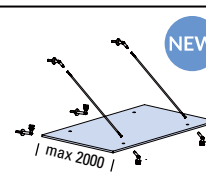

PROJECT FIVE

Attacco doppio a parete
Double rod connector
Doppel Zugstangeverbindung

▶ 509

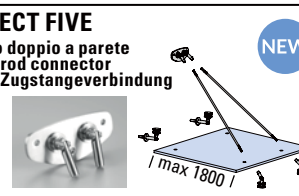

TEKNO

▶ 512

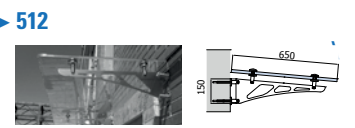

BALAUSTRÉ / RAILING SYSTEMS / GANZGLASGELÄNDER SYSTEME



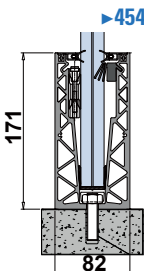
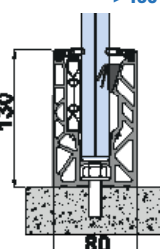
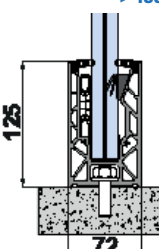
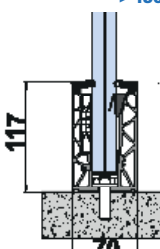
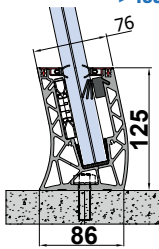
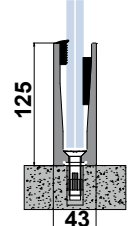

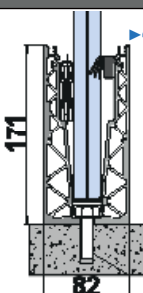
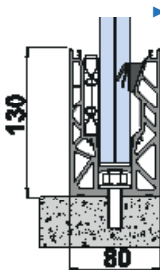
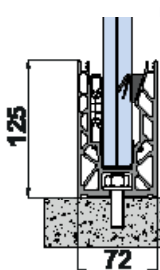
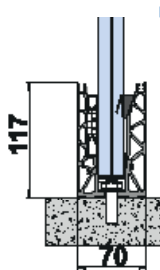

FISSAGGIO A PAVIMENTO / FLOOR INSTALLATION / BODENMONTAGE

		B-7500		B-8500		B-8000-WN		B-8700		B-2100		B-1100	
													
		Class	€	Class	€	Class	€	Class	€	€	€	€	€
Pricelist 8+8	1	€ 365,00	2	€ 332,30	2	€ 255,30	2*	€ 229,00	€ 327,50	€ 234,50			
Pricelist 10+10	2	€ 361,30	3	€ 328,30	2^	€ 252,70	2	€ 227,00	€ 323,50	€ 232,00			
Pricelist 12+12	3	€ 391,00	3	€ 341,30	3	€ 274,00	-	-	€ 353,70	-			
IB > 30 mt 8+8	1	€ 330,50	2	€ 298,70	2	€ 235,00	2*	€ 212,50	€ 287,30	€ 206,00			
IB > 30 mt 10+10	2	€ 328,30	3	€ 296,50	2^	€ 233,00	2	€ 209,00	€ 283,00	€ 203,30			
IB > 30 mt 12+12	3	€ 346,00	3	€ 316,50	3	€ 252,70	-	-	€ 296,50	-			
IB > 72 mt 8+8	1	€ 318,70	2	€ 287,30	2	€ 223,30	2*	€ 200,70	€ 275,00	€ 206,00			
IB > 72 mt 10+10	2	€ 316,50	3	€ 284,70	2^	€ 221,00	2	€ 197,30	€ 271,30	€ 203,30			
IB > 72 mt 12+12	3	€ 334,30	3	€ 304,70	3	€ 241,30	-	-	€ 284,70	-			

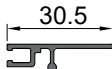
FISSAGGIO A PAVIMENTO GREZZE (senza velette) / FLOOR INSTALLATION RAW (without cover profiles) / BODENMONTAGE ROH (ohne Abdeckungen)

		B-7500-G		B-8500-G		B-8000-WN-G		B-8700-G	
									
		Class	€	Class	€	Class	€	Class	€
Pricelist 8+8	1	€ 309,70	2	€ 294,00	2	€ 233,00	2*	€ 203,30	
Pricelist 10+10	2	€ 305,70	3	€ 291,70	2^	€ 230,50	2	€ 200,70	
Pricelist 12+12	3	€ 332,30	3	€ 305,70	3	€ 254,00	-	-	
IB > 30 mt 8+8	1	€ 288,30	2	€ 255,30	2	€ 207,00	2*	€ 191,70	
IB > 30 mt 10+10	2	€ 286,30	3	€ 252,70	2^	€ 204,50	2	€ 189,00	
IB > 30 mt 12+12	3	€ 303,50	3	€ 275,00	3	€ 224,30	-	-	
IB > 72 mt 8+8	1	€ 276,30	2	€ 243,30	2	€ 195,00	2*	€ 179,50	
IB > 72 mt 10+10	2	€ 274,00	3	€ 241,30	2^	€ 192,70	2	€ 177,30	
IB > 72 mt 12+12	3	€ 291,70	3	€ 263,70	3	€ 212,50	-	-	

VELETTE / COVER PROFILES / ABDECKUNGEN

		B-8001 (for B-8000-WN-G, B-8700-G, B-8500-G and B-8300-G)		B-8051 (for B-8000-WN-G, B-8700-G, B-8500-G and B-8300-G)		B-6001 (for B-7500-G)		B-6051 (for B-7500-G)	
									
		3000 mm	6000 mm	3000 mm	6000 mm	3000 mm	6000 mm	3000 mm	6000 mm
Pricelist		€ 90,00	€ 126,00	€ 101,30	€ 147,50	€ 102,00	€ 142,50	€ 115,00	€ 166,30
IB > 30 mt		€ 35,70	€ 48,30	€ 42,00	€ 59,30	€ 36,70	€ 48,00	€ 42,00	€ 59,70
IB > 72 mt		€ 32,30	€ 44,70	€ 38,30	€ 55,70	€ 33,30	€ 44,50	€ 38,30	€ 56,30
IB > 72 mt	GR 	€ 26,00	€ 33,50	GR = grezza / raw / Roh					

FISSAGGIO LATERALE / FLOOR INSTALLATION WITH SIDE FIXING / BODENMONTAGE MIT SEITLICHER BEFESTIGUNG

		B-8300	B-8300-G	B-1101
	Class	€	€	€
Pricelist 8+8	1	€ 291,70	€ 265,50	€ 263,70
Pricelist 10+10	2	€ 288,30	€ 261,70	€ 261,00
Pricelist 12+12	3	€ 300,00	€ 284,70	-
IB > 30 mt 8+8	1	€ 268,30	€ 233,00	€ 248,70
IB > 30 mt 10+10	2	€ 264,70	€ 229,00	€ 246,30
IB > 30 mt 12+12	3	€ 276,30	€ 241,30	-
IB > 72 mt 8+8	1	€ 256,30	€ 221,00	€ 248,70
IB > 72 mt 10+10	2	€ 252,70	€ 217,30	€ 246,30
IB > 72 mt 12+12	3	€ 264,70	€ 229,00	-

IB>30 - 6 mt
Per la fascia IB >30 nella misura da 6 mt è necessario calcolare + € 10,00 al mt sul prezzo dei 30 mt.

IB>30 - 6 mt
For the profile length 6 mt please add + € 10,00 each mt to the 30 mt price

IB>30 - 6 mt
Für Profilänge 6 mt bitte addieren + € 10,00 pro mt zum 30 mt Preis

***B-8700**
certified class 2

8+8 (pvb 1.52)

NOT certified class 2

8+8 (pvb 1.52)

B-8000-WN
certified class 3

10+10 (pvb 1.52)

for class 3

Aggiungere / Add / Hinzufügen

- 1 pc B-8008 / m
- 2 pcs B-2005 / m

VELETTE / COVER PROFILES / ABDECKUNGEN

		B-8121 (for B-8000-G)				B-8721 (for B-8700-G)			
		▶472				▶472			
Length		3000 mm AN	6000 mm AN	3000 mm IXE	6000 mm IXE	3000 mm AN	6000 mm AN	3000 mm BI	6000 mm BI
Pricelist		€ 267,50	€ 431,70	€ 355,30	€ 639,70	€ 247,30	€ 396,00	€ 311,50	€ 537,30
IB > 30 mt		€ 94,50	€ 168,70	€ 141,70	€ 271,30	€ 89,00	€ 166,00	€ 124,30	€ 242,00
IB > 72 mt		€ 94,00	€ 164,30	€ 135,00	€ 267,50	€ 83,50	€ 160,50	€ 119,00	€ 236,50

FISSAGGIO INCASSATO / RECESSED IN THE FLOOR / IM BODEN VERSENKT

		B-4050		B-2060	
		 ▶462 92		 ▶462 not included 72	
Class		€		€	
Pricelist 8+8	1	€ 213,30		€ 191,00	
Pricelist 10+10	2	€ 209,50		€ 209,50	
Pricelist 12+12	3	€ 249,70		-	
IB > 30 mt 8+8	1	€ 211,50		€ 180,30	
IB > 30 mt 10+10	2	€ 208,70		€ 197,30	
IB > 30 mt 12+12	3	€ 231,30		-	
IB > 72 mt 8+8	1	€ 199,70		€ 180,30	
IB > 72 mt 10+10	2	€ 197,00		€ 197,30	
IB > 72 mt 12+12	3	€ 219,50		-	

FISSAGGIO ESTERNO / SIDE INSTALLATION / SEITENMONTAGE

		B-8200 B-8200-G (without cover profiles)		B-8250-WN B-8250-WN-G (without cover profiles)		B-8260-WN B-8260-WN-G (without cover profiles)		B-7550-G (without cover profiles)		B-6220	
		 ▶463 196 75		 ▶464 140 75		 ▶464 140 75		 ▶463 171 82		 ▶465 200 66	
Class		€		€		€		€		€	
Pricelist 8+8	1	€ 352,00	€ 269,30	€ 297,50	€ 227,00	€ 305,70	€ 235,00	€ 380,00	€ 395,30	€ 395,30	€ 395,30
Pricelist 10+10	2	€ 349,70	€ 267,00	€ 295,00	€ 224,30	€ 303,50	€ 233,00	€ 376,30	€ 391,70	€ 391,70	€ 391,70
Pricelist 12+12	3	€ 360,30	€ 279,00	€ 304,70	€ 236,00	€ 313,00	€ 244,50	€ 403,50	€ 410,00	€ 410,00	€ 410,00
IB > 30 mt 8+8	1	€ 325,00	€ 254,00	€ 275,00	€ 211,50	€ 283,30	€ 219,70	€ 367,70	€ 357,70	€ 357,70	€ 357,70
IB > 30 mt 10+10	2	€ 322,50	€ 251,50	€ 271,50	€ 208,00	€ 280,00	€ 216,30	€ 364,30	€ 355,00	€ 355,00	€ 355,00
IB > 30 mt 12+12	3	€ 343,50	€ 259,70	€ 293,00	€ 228,00	€ 301,30	€ 236,00	€ 384,30	€ 373,30	€ 373,30	€ 373,30
IB > 72 mt 8+8	1	€ 313,00	€ 242,30	€ 263,70	€ 199,70	€ 271,50	€ 208,00	€ 356,00	€ 346,00	€ 346,00	€ 346,00
IB > 72 mt 10+10	2	€ 310,70	€ 239,70	€ 259,70	€ 196,30	€ 268,30	€ 204,50	€ 352,30	€ 343,30	€ 343,30	€ 343,30
IB > 72 mt 12+12	3	€ 332,30	€ 271,50	€ 281,00	€ 216,30	€ 289,30	€ 224,30	€ 372,50	€ 361,30	€ 361,30	€ 361,30

VELETTE / COVER PROFILES / ABDECKUNGEN

		B-8201 (for B-8200-G)		B-8251 (for B-8250-G and B-2860-G)		B-6201 (for B-6220)	
		▶471		▶471		▶471	
Length		3000 mm AN	6000 mm AN	3000 mm AN	6000 mm AN	3000 mm AN	6000 mm AN
Pricelist		€ 244,00	€ 485,50	€ 237,50	-	€ 258,00	€ 515,50
IB > 30 mt		€ 200,30	€ 390,70	€ 202,30	€ 392,30	€ 192,30	€ 349,30
IB > 72 mt		€ 197,00	€ 387,50	€ 198,00	€ 387,70	€ 189,00	€ 346,00

FISSAGGIO A MURETTO / LOW WALL / AUF ATTIKAMAUER

		B-3600 H = 700 mm		B-3500-N H = 700 mm	
		 Fine serie Product will be discontinued Auslaufmodell *CLASS 1 ▶465		 ▶466	
	Class	€		€	
Pricelist 6+6	1	€ 212,50		€ 186,50	
Pricelist 8+8	2	€ 212,50		€ 186,50	
IB > 30 mt 6+6	1	€ 189,00		€ 172,00	
IB > 30 mt 8+8	2	€ 189,00		€ 172,00	
IB > 72 mt 6+6	1	€ 177,30		€ 160,00	
IB > 72 mt 8+8	2	€ 177,30		€ 160,00	

FISSAGGIO A PAVIMENTO A PEZZI / FLOOR INSTALLATION IN PIECES / BODENMONTAGE IN TEILE

		UB-120 L = 120 mm		UB-220 L = 220 mm		B-7520 L = 125 mm		B-7120 L = 250 mm	
		 ▶458		 ▶458		 ▶454		 ▶459	
	Class	AG	GR	AG	GR	Class	€ / pc	€ / pc	
Pricelist 8+8	1	€ 227,00	€ 200,70	€ 310,70	€ 283,30	1	€ 184,00	€ 169,50	
Pricelist 10+10	2	€ 224,30	€ 198,50	€ 308,50	€ 280,00	1	€ 180,30	€ 168,50	
IB > 20 pc 8+8	1	€ 195,00	€ 175,00	€ 276,30	€ 246,70		€ 150,70	€ 133,00	
IB > 20 pc 10+10	2	€ 191,70	€ 171,30	€ 270,50	€ 239,70		€ 147,50	€ 131,00	
IB > 40 pc 8+8	1	€ 183,30	€ 163,00	€ 264,70	€ 235,00		€ 139,00	€ 121,30	
IB > 40 pc 10+10	2	€ 179,50	€ 160,00	€ 258,50	€ 228,00		€ 135,50	€ 119,00	

VELETTE / COVER PROFILES / ABDECKUNGEN

		B-3501 (B-3500-N and B-3600)		B-3551 (B-3500-N and B-3600)		B-8061	
		 ▶470		 ▶471		 ▶472	
Length		3000 mm	6000 mm	3000 mm	6000 mm		3000 mm 6000 mm
Pricelist		€ 81,00	€ 107,00	€ 93,50	€ 132,70		€ 86,70 € 127,30
IB > 30 mt		€ 29,30	€ 38,30	€ 36,30	€ 50,70		€ 65,30 € 112,50
IB > 72 mt		€ 26,00	€ 35,00	€ 32,70	€ 47,50		€ 58,70 € 105,70

POS.	PROD.	ART.	FIN.	MIS.	Q.TÀ	EURO	Q.TÀ	EURO
------	-------	------	------	------	------	------	------	------

B-7500 / B-7500-G SMARTONE

► BALAUSTR E PENSILINE 32

<p>H.01</p> <p>B-7500</p> <p>B-7500-G</p> <p>B-6051 B-6001</p>	<p>B-7500 (8+8)</p>	AN	3000 mm	1 set	365,00 /m			1095,00 /bar	
	<p>B-7500 (10+10)</p>	AN	3000 mm	1 set	361,30 /m			1083,90 /bar	
	<p>B-7500 (12+12)</p>	AN	3000 mm	1 set	391,00 /m			1173,00 /bar	
	<p>B-7500-0,8-CH-12</p>	AN	3000 mm	1 set	361,30 /m			1083,90 /bar	
	<p>*B-7500-G (8+8)</p>	GR	3000 mm	1 set	309,70 /m			929,10 /bar	
	<p>*B-7500-G (10+10)</p>	GR	3000 mm	1 set	305,70 /m			917,10 /bar	
	<p>*B-7500-G (12+12)</p>	GR	3000 mm	1 set	332,30 /m			996,90 /bar	
	<p>*B-7500-G-CH-12</p>	GR	3000 mm	1 set	305,70 /m			917,10 /bar	
	<p>IB-7500 (8+8)</p>	AN	3000 mm	■ min 30 m	330,50 /m	991,50 /bar	■ min 72 m	318,70 /m	956,10 /bar
	<p>IB-7500 (10+10)</p>	AN	3000 mm	■ min 30 m	328,30 /m	984,90 /bar	■ min 72 m	316,50 /m	949,50 /bar
	<p>IB-7500 (12+12)</p>	AN	3000 mm	■ min 30 m	346,00 /m	1038,00 /bar	■ min 72 m	334,30 /m	1002,90 /bar
	<p>IB-7500-0,8-CH-12</p>	AN	3000 mm	■ min 30 m	-		■ min 72 m	-	
	<p>*IB-7500-G (8+8)</p>	GR	3000 mm	■ min 30 m	288,30 /m	864,90 /bar	■ min 72 m	276,30 /m	828,90 /bar
	<p>*IB-7500-G (10+10)</p>	GR	3000 mm	■ min 30 m	286,30 /m	858,90 /bar	■ min 72 m	274,00 /m	822,00 /bar
<p>*IB-7500-G (12+12)</p>	GR	3000 mm	■ min 30 m	303,50 /m	910,50 /bar	■ min 72 m	291,70 /m	875,10 /bar	
<p>*IB-7500-G-CH-12</p>	GR	3000 mm	■ min 30 m	-		■ min 72 m	-		

B-7520 SMARTONE A PEZZI / IN PIECES / IN TEILE

► BALAUSTR E PENSILINE 74

<p>H.02</p>	<p>B-7520 (8+8)</p>	AN	125 mm	1 pc	184,00 /pc				
	<p>B-7520 (10+10)</p>	AN	125 mm	1 pc	180,30 /pc				
	<p>IB-7520 (8+8)</p>	AN	125 mm	■ min 20 pcs	150,70 /pc		■ min 40 pcs	139,00 /pc	
	<p>IB-7520 (10+10)</p>	AN	125 mm	■ min 20 pcs	147,50 /pc		■ min 40 pcs	135,50 /pc	

-
- Confezioni industriali
- Industrial packaging
- Industrieverpackungen
- *
- Senza vellete
- Without cover profiles
- Ohne Abdeckungen

POS.	PROD.	ART.	FIN.	MIS.	Q.TÀ	EURO	Q.TÀ	EURO
------	-------	------	------	------	------	------	------	------

B-8000-WN CMR ▶ BALAUSTR E PENSILINE 26

H.03 	B-8000-WN (8+8) AN	3000 mm	1 set	255,30 /m			765,90 /bar		
		6000 mm	1 set	255,30 /m			1531,80 /bar		
		B-8000-WN (10+10) AN	3000 mm	1 set	252,70 /m			758,10 /bar	
			6000 mm	1 set	250,30 /m			1501,80 /bar	
		B-8000-WN (12+12) AN	3000 mm	1 set	274,00 /m			822,00 /bar	
			6000 mm	1 set	274,00 /m			1644,00 /bar	
	IB-8000-WN (8+8) AN	3000 mm	■ min 30 m	235,00 /m	705,00 /bar	■ min 72 m	223,30 /m	669,90 /bar	
		6000 mm	■ min 30 m	245,70 /m	1474,20 /bar	■ min 72 m	223,30 /m	1339,80 /bar	
	IB-8000-WN (10+10) AN	3000 mm	■ min 30 m	233,00 /m	699,00 /bar	■ min 72 m	221,00 /m	663,00 /bar	
		6000 mm	■ min 30 m	243,50 /m	1461,00 /bar	■ min 72 m	221,00 /m	1326,00 /bar	
	IB-8000-WN (12+12) AN	3000 mm	■ min 30 m	252,70 /m	758,10 /bar	■ min 72 m	241,30 /m	723,90 /bar	
		6000 mm	■ min 30 m	263,30 /m	1579,80 /bar	■ min 72 m	241,30 /m	1447,80 /bar	

B-8000-WN-G CMR ▶ BALAUSTR E PENSILINE 28

H.04 	*B-8000-WN-G (8+8) GR	3000 mm	1 set	233,00 /m			699,00 /bar		
		6000 mm	1 set	233,00 /m			1398,00 /bar		
	*B-8000-WN-G (10+10) GR	3000 mm	1 set	230,50 /m			691,50 /bar		
		6000 mm	1 set	230,50 /m			1383,00 /bar		
	*B-8000-WN-G (12+12) GR	3000 mm	1 set	254,00 /m			762,00 /bar		
		6000 mm	1 set	254,00 /m			1524,00 /bar		
	B-8001-CF2 AN	3000 mm	2 pcs	15,00 /m			90,00 /2 bars		
		6000 mm	2 pcs	10,50 /m			126,00 /2 bars		
	B-8051-CF2 AN	3000 mm	2 pcs	16,88 /m			101,30 /2 bars		
		6000 mm	2 pcs	12,29 /m			147,50 /2 bars		
	B-8121-CF2 AN	3000 mm	2 pcs	44,58 /m			267,50 /2 bars		
		6000 mm	2 pcs	35,98 /m			431,70 /2 bars		
		IXE	3000 mm	2 pcs	59,22 /m			355,30 /2 bars	
			6000 mm	2 pcs	53,31 /m			639,70 /2 bars	
	*IB-8000-WN-G (8+8) GR	3000 mm	■ min 30 m	207,00 /m	621,00 /bar	■ min 72 m	195,00 /m	585,00 /bar	
		6000 mm	■ min 30 m	217,70 /m	1306,20 /bar	■ min 72 m	195,00 /m	1170,00 /bar	
	*IB-8000-WN-G (10+10) GR	3000 mm	■ min 30 m	204,50 /m	613,50 /bar	■ min 72 m	192,70 /m	578,10 /bar	
		6000 mm	■ min 30 m	215,30 /m	1291,80 /bar	■ min 72 m	192,70 /m	1156,20 /bar	
	*IB-8000-WN-G (12+12) GR	3000 mm	■ min 30 m	224,30 /m	672,90 /bar	■ min 72 m	212,50 /m	637,50 /bar	
		6000 mm	■ min 30 m	235,00 /m	1410,00 /bar	■ min 72 m	212,50 /m	1275,00 /bar	
	IB-8001 AN	3000 mm	■ min 30 m	11,90 /m	35,70 /bar	■ min 72 m	10,77 /m	32,30 /bar	
		6000 mm	■ min 30 m	8,05 /m	48,30 /bar	■ min 72 m	7,45 /m	44,70 /bar	
	IB-8051 AN	3000 mm	■ min 30 m	14,00 /m	42,00 /bar	■ min 72 m	12,77 /m	38,30 /bar	
		6000 mm	■ min 30 m	9,88 /m	59,30 /bar	■ min 72 m	9,28 /m	55,70 /bar	
IB-8121 AN	3000 mm	■ min 30 m	31,50 /m	94,50 /bar	■ min 72 m	31,33 /m	94,00 /bar		
	6000 mm	■ min 30 m	28,12 /m	168,70 /bar	■ min 72 m	27,38 /m	164,30 /bar		
	IXE	3000 mm	■ min 30 m	47,23 /m	141,70 /bar	■ min 72 m	45,00 /m	135,00 /bar	
		6000 mm	■ min 30 m	45,22 /m	271,30 /bar	■ min 72 m	44,58 /m	267,50 /bar	

^ vedi pagina | see page | siehe Seite ▶ 451

POS.	PROD.	ART.	FIN.	MIS.	Q.TÀ	EURO	Q.TÀ	EURO
------	-------	------	------	------	------	------	------	------

B-8700 CMR										
H.04.1		B-8700 (8+8)*	AN	3000 mm	1 set	229,00 /m		687,00 /bar		
				6000 mm	1 set	229,00 /m		1374,00 /bar		
		B-8700 (10+10)	AN	3000 mm	1 set	227,00 /m		681,00 /bar		
				6000 mm	1 set	227,00 /m		1362,00 /bar		
		IB-8700 (8+8)*	AN	3000 mm	■ min 30 m	212,50 /m	637,50 /bar	■ min 72 m	200,70 /m	602,10 /bar
				6000 mm	■ min 30 m	223,30 /m	1339,80 /bar	■ min 72 m	200,70 /m	1204,20 /bar
		IB-8700 (10+10)	AN	3000 mm	■ min 30 m	209,00 /m	627,00 /bar	■ min 72 m	197,30 /m	591,90 /bar
				6000 mm	■ min 30 m	219,70 /m	1318,20 /bar	■ min 72 m	197,30 /m	1183,80 /bar

B-8700-G CMR										
H.04.2		*B-8700-G (8+8)*	GR	3000 mm	1 set	203,30 /m		609,90 /bar		
				6000 mm	1 set	203,30 /m		1219,80 /bar		
		*B-8700-G (10+10)	GR	3000 mm	1 set	200,70 /m		602,10 /bar		
				6000 mm	1 set	200,70 /m		1204,20 /bar		
		B-8001-CF2	AN	3000 mm	2 pcs	15,00 /m		90,00 /2 bars		
				6000 mm	2 pcs	10,50 /m		126,00 /2 bars		
		B-8051-CF2	AN	3000 mm	2 pcs	16,88 /m		101,30 /2 bars		
				6000 mm	2 pcs	12,29 /m		147,50 /2 bars		
		B-8721-CF2	AN	3000 mm	2 pcs	41,22 /m		247,30 /2 bars		
				6000 mm	2 pcs	33,00 /m		396,00 /2 bars		
			BI	3000 mm	2 pcs	51,92 /m		311,50 /2 bars		
				6000 mm	2 pcs	44,78 /m		537,30 /2 bars		
		IB-8700-G (8+8)	GR	3000 mm	■ min 30 m	191,70 /m	575,10 /bar	■ min 72 m	179,50 /m	538,50 /bar
				6000 mm	■ min 30 m	202,30 /m	1213,80 /bar	■ min 72 m	179,50 /m	1077,00 /bar
		*IB-8700-G (10+10)	GR	3000 mm	■ min 30 m	189,00 /m	567,00 /bar	■ min 72 m	177,30 /m	531,90 /bar
				6000 mm	■ min 30 m	199,70 /m	1198,20 /bar	■ min 72 m	177,30 /m	1063,80 /bar
		IB-8001	AN	3000 mm	■ min 30 m	11,90 /m	35,70 /bar	■ min 72 m	10,77 /m	32,30 /bar
				6000 mm	■ min 30 m	8,05 /m	48,30 /bar	■ min 72 m	7,45 /m	44,70 /bar
		IB-8051	AN	3000 mm	■ min 30 m	14,00 /m	42,00 /bar	■ min 72 m	12,77 /m	38,30 /bar
				6000 mm	■ min 30 m	9,88 /m	59,30 /bar	■ min 72 m	9,28 /m	55,70 /bar
IB-8721	AN	3000 mm	■ min 30 m	29,67 /m	89,00 /bar	■ min 72 m	27,83 /m	83,50 /bar		
		6000 mm	■ min 30 m	27,67 /m	166,00 /bar	■ min 72 m	26,75 /m	160,50 /bar		
	BI	3000 mm	■ min 30 m	41,43 /m	124,30 /bar	■ min 72 m	39,67 /m	119,00 /bar		
		6000 mm	■ min 30 m	40,33 /m	242,00 /bar	■ min 72 m	39,42 /m	236,50 /bar		

* vedi pagina | see page | siehe Seite ► 451

-
- Confezioni industriali
- Industrial packaging
- Industrieverpackungen
- * Senza vellete
- Without cover profiles
- Ohne Abdeckungen

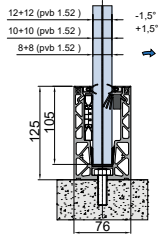

POS.	PROD.	ART.	FIN.	MIS.	Q.TÀ	EURO	Q.TÀ	EURO
------	-------	------	------	------	------	------	------	------

B-6000 SMARTØNE
► BALAUSTR E PENSILINE 34
H.05

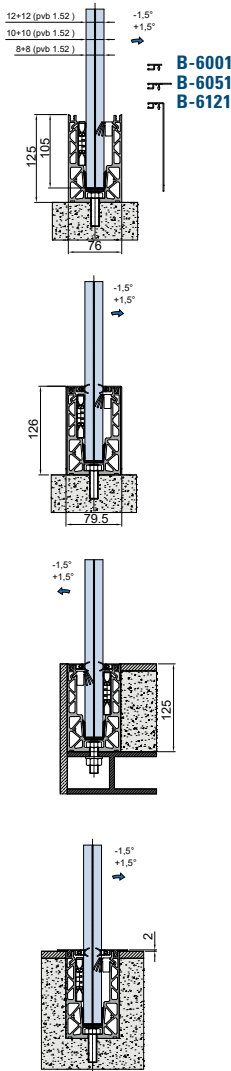
B-6000 (8+8)	AN	3000 mm	1 set	277,70 /m			833,10 /bar	
		6000 mm	1 set	277,70 /m			1666,20 /bar	
B-6000 (10+10)	AN	3000 mm	1 set	274,00 /m			822,00 /bar	
		6000 mm	1 set	274,00 /m			1644,00 /bar	
B-6000 (12+12)	AN	3000 mm	1 set	294,00 /m			882,00 /bar	
		6000 mm	1 set	294,00 /m			1764,00 /bar	
IB-6000 (8+8)	AN	3000 mm	■ min 30 m	267,00 /m	801,00 /bar	■ min 72 m	255,30 /m	765,90 /bar
		6000 mm	■ min 30 m	277,50 /m	1665,00 /bar	■ min 72 m	255,30 /m	1531,80 /bar
IB-6000 (10+10)	AN	3000 mm	■ min 30 m	262,30 /m	786,90 /bar	■ min 72 m	250,50 /m	751,50 /bar
		6000 mm	■ min 30 m	273,00 /m	1638,00 /bar	■ min 72 m	250,50 /m	1503,00 /bar
IB-6000 (12+12)	AN	3000 mm	■ min 30 m	283,30 /m	849,90 /bar	■ min 72 m	271,50 /m	814,50 /bar
		6000 mm	■ min 30 m	294,00 /m	1764,00 /bar	■ min 72 m	271,50 /m	1629,00 /bar

B-6000-G SMARTØNE
► BALAUSTR E PENSILINE 36
H.06

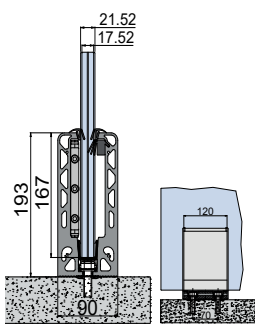
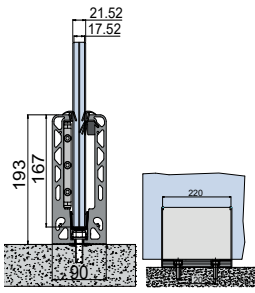
*B-6000-G (8+8)	GR	3000 mm	1 set	225,30 /m			675,90 /bar	
		6000 mm	1 set	225,30 /m			1351,80 /bar	
*B-6000-G (10+10)	GR	3000 mm	1 set	221,50 /m			664,50 /bar	
		6000 mm	1 set	221,50 /m			1329,00 /bar	
*B-6000-G (12+12)	GR	3000 mm	1 set	243,30 /m			729,90 /bar	
		6000 mm	1 set	243,30 /m			1459,80 /bar	
B-6001-CF2	AN	3000 mm	2 pcs	17,00 /m			102,00 /2 bars	
		6000 mm	2 pcs	11,88 /m			142,50 /2 bars	
B-6051-CF2	AN	3000 mm	2 pcs	19,17 /m			115,00 /2 bars	
		6000 mm	2 pcs	13,86 /m			166,30 /2 bars	
B-6121-CF2	AN	3000 mm	2 pcs	48,72 /m			292,30 /2 bars	
		6000 mm	2 pcs	39,38 /m			472,50 /2 bars	
	IXE	3000 mm	2 pcs	53,83 /m			323,00 /2 bars	
		6000 mm	2 pcs	44,78 /m			537,30 /2 bars	
*IB-6000-G (8+8)	GR	3000 mm	■ min 30 m	221,30 /m	663,90 /bar	■ min 72 m	209,50 /m	628,50 /bar
		6000 mm	■ min 30 m	232,00 /m	1392,00 /bar	■ min 72 m	209,50 /m	1257,00 /bar
*IB-6000-G (10+10)	GR	3000 mm	■ min 30 m	218,00 /m	654,00 /bar	■ min 72 m	206,00 /m	618,00 /bar
		6000 mm	■ min 30 m	228,50 /m	1371,00 /bar	■ min 72 m	206,00 /m	1236,00 /bar
*IB-6000-G (12+12)	GR	3000 mm	■ min 30 m	239,50 /m	718,50 /bar	■ min 72 m	227,70 /m	683,10 /bar
		6000 mm	■ min 30 m	250,30 /m	1501,80 /bar	■ min 72 m	227,70 /m	1366,20 /bar
IB-6001	AN	3000 mm	■ min 30 m	12,23 /m	36,70 /bar	■ min 72 m	11,10 /m	33,30 /bar
		6000 mm	■ min 30 m	8,00 /m	48,00 /bar	■ min 72 m	7,42 /m	44,50 /bar
IB-6051	AN	3000 mm	■ min 30 m	14,00 /m	42,00 /bar	■ min 72 m	12,77 /m	38,30 /bar
		6000 mm	■ min 30 m	9,95 /m	59,70 /bar	■ min 72 m	9,38 /m	56,30 /bar
IB-6121	AN	3000 mm	■ min 30 m	29,77 /m	89,30 /bar	■ min 72 m	28,67 /m	86,00 /bar
		6000 mm	■ min 30 m	27,25 /m	163,50 /bar	■ min 72 m	26,67 /m	160,00 /bar
	IXE	3000 mm	■ min 30 m	-	-	■ min 72 m	-	-
		6000 mm	■ min 30 m	-	-	■ min 72 m	-	-

POS.	PROD.	ART.	FIN.	MIS.	Q.TÀ	EURO	Q.TÀ	EURO
H.07								
H.08								
H.09								
H.10								
UB-120 UNIBLOCK						▶ BALAUSTR E PENSILINE 66		
H.10.1		UB-120 (8+8)	AG	120 mm	1 pc	227,00 /pc		
		UB-120 (10+10)	AG	120 mm	1 pc	224,30 /pc		
		UB-120-G (8+8)	GR	120 mm	1 pc	200,70 /pc		
		UB-120-G (10+10)	GR	120 mm	1 pc	198,50 /pc		
		IUB-120 (8+8)	AG	120 mm	■ min 20 pcs	195,00 /pc	■ min 40 pcs	183,30 /pc
		IUB-120 (10+10)	AG	120 mm	■ min 20 pcs	191,70 /pc	■ min 40 pcs	179,50 /pc
		IUB-120-G (8+8)	GR	120 mm	■ min 20 pcs	175,00 /pc	■ min 40 pcs	163,00 /pc
		IUB-120-G (10+10)	GR	120 mm	■ min 20 pcs	171,30 /pc	■ min 40 pcs	160,00 /pc
UB-220 UNIBLOCK						▶ BALAUSTR E PENSILINE 70		
H.10.2		UB-220 (8+8)	AG	220 mm	1 pc	310,70 /pc		
		UB-220 (10+10)	AG	220 mm	1 pc	308,50 /pc		
		UB-220-G (8+8)	GR	220 mm	1 pc	283,30 /pc		
		UB-220-G (10+10)	GR	220 mm	1 pc	280,00 /pc		
		IUB-220 (8+8)	AG	220 mm	■ min 20 pcs	276,30 /pc	■ min 40 pcs	264,70 /pc
		IUB-220 (10+10)	AG	220 mm	■ min 20 pcs	270,50 /pc	■ min 40 pcs	258,50 /pc
		IUB-220-G (8+8)	GR	220 mm	■ min 20 pcs	246,70 /pc	■ min 40 pcs	235,00 /pc
		IUB-220-G (10+10)	GR	220 mm	■ min 20 pcs	239,70 /pc	■ min 40 pcs	228,00 /pc
UB-122						▶ BALAUSTR E PENSILINE 72		
H.10.3		UB-122	AN	3000 mm	4 pc	141,70 /set		
			AN	6000 mm	4 pc	221,00 /set		
		IUB-122	AN	3000 mm	■ min 14 pcs	28,70 /pc		
			AN	6000 mm	■ min 14 pcs	43,00 /pc		

-
- Confezioni industriali
- Industrial packaging
- Industrieverpackungen
- *
 - Senza vellete
 - Without cover profiles
 - Ohne Abdeckungen

POS.	PROD.	ART.	FIN.	MIS.	Q.TÀ	EURO	Q.TÀ	EURO	
B-7120 SMARTØNE A PEZZI / IN PIECES / IN TEILE						▶ BALAUSTRÉ E PENSILINE 75			
H.11		B-7120 (8+8)	AN	250 mm	1 pc	169,50 /pc			
		B-7120 (10+10)	AN	250 mm	1 pc	168,50 /pc			
		IB-7120 (8+8)	AN	250 mm	■ min 20 pcs	133,00 /pc	■ min 40 pcs	121,30 /pc	
		IB-7120 (10+10)	AN	250 mm	■ min 20 pcs	131,00 /pc	■ min 40 pcs	119,00 /pc	
B-7220 SMARTØNE A PEZZI / IN PIECES / IN TEILE						▶ BALAUSTRÉ E PENSILINE 75			
H.12		B-7220 (8+8)	AN	250 mm	1 pc	183,70 /pc			
		B-7220 (10+10)	AN	250 mm	1 pc	179,50 /pc			
		IB-7220 (8+8)	AN	250 mm	■ min 20 pcs	136,50 /pc	■ min 40 pcs	125,00 /pc	
		IB-7220 (10+10)	AN	250 mm	■ min 20 pcs	134,30 /pc	■ min 40 pcs	122,70 /pc	
H.13									
H.14									
B-2100 ONDA SMARTØNE						▶ BALAUSTRÉ E PENSILINE 46			
H.15		B-2100 (8+8)		3000 mm	1 set	327,50 /m		982,50 /bar	
		B-2100 (10+10)		3000 mm	1 set	323,50 /m		970,50 /bar	
		B-2100 (12+12)		3000 mm	1 set	353,70 /m		1061,10 /bar	
		IB-2100 (8+8)		3000 mm	■ min 30 m	287,30 /m	861,90 /bar	■ min 72 m	275,00 /m 825,00 /bar
		IB-2100 (10+10)		3000 mm	■ min 30 m	283,00 /m	849,00 /bar	■ min 72 m	271,30 /m 813,90 /bar
		IB-2100 (12+12)		3000 mm	■ min 30 m	296,50 /m	889,50 /bar	■ min 72 m	284,70 /m 854,10 /bar

POS.	PROD.	ART.	FIN.	MIS.	Q.TÀ	EURO	Q.TÀ	EURO
------	-------	------	------	------	------	------	------	------

B-8500 CMR

H.15.1		B-8500 (8+8)	AN	3000 mm	1 set	332,30 /m		996,90 /bar		
				6000 mm	1 set	332,30 /m		1993,80 /bar		
		B-8500 (10+10)	AN	3000 mm	1 set	328,30 /m		984,90 /bar		
				6000 mm	1 set	328,30 /m		1969,80 /bar		
		B-8500 (12+12)	AN	3000 mm	1 set	341,30 /m		1023,90 /bar		
				6000 mm	1 set	341,30 /m		2047,80 /bar		
		IB-8500 (8+8)	AN	3000 mm	■ min 30 m	298,70 /m	896,10 /bar	■ min 72 m	287,30 /m	861,90 /bar
				6000 mm	■ min 30 m	309,30 /m	1855,80 /bar	■ min 72 m	287,30 /m	1723,80 /bar
		IB-8500 (10+10)	AN	3000 mm	■ min 30 m	296,50 /m	889,50 /bar	■ min 72 m	284,70 /m	854,10 /bar
				6000 mm	■ min 30 m	307,30 /m	1843,80 /bar	■ min 72 m	284,70 /m	1708,20 /bar
		IB-8500 (12+12)	AN	3000 mm	■ min 30 m	316,50 /m	949,50 /bar	■ min 72 m	304,70 /m	914,10 /bar
				6000 mm	■ min 30 m	327,30 /m	1963,80 /bar	■ min 72 m	304,70 /m	1828,20 /bar

B-8500-G CMR

H.15.2		*B-8500-G (8+8)	GR	3000 mm	1 set	294,00 /m		882,00 /bar		
				6000 mm	1 set	294,00 /m		1764,00 /bar		
		*B-8500-G (10+10)	GR	3000 mm	1 set	291,70 /m		875,10 /bar		
				6000 mm	1 set	291,70 /m		1750,20 /bar		
		*B-8500-G (12+12)	GR	3000 mm	1 set	305,70 /m		917,10 /bar		
				6000 mm	1 set	305,70 /m		1834,20 /bar		
		B-8001-CF2	AN	3000 mm	2 pcs	15,00 /m		90,00 /2 bars		
				6000 mm	2 pcs	10,50 /m		126,00 /2 bars		
		B-8051-CF2	AN	3000 mm	2 pcs	16,88 /m		101,30 /2 bars		
				6000 mm	2 pcs	12,29 /m		147,50 /2 bars		
		*IB-8500-G (8+8)	GR	3000 mm	■ min 30 m	255,30 /m	765,90 /bar	■ min 72 m	243,30 /m	729,90 /bar
				6000 mm	■ min 30 m	266,00 /m	1596,00 /bar	■ min 72 m	243,30 /m	1459,80 /bar
		*IB-8500-G (10+10)	GR	3000 mm	■ min 30 m	252,70 /m	758,10 /bar	■ min 72 m	241,30 /m	723,90 /bar
				6000 mm	■ min 30 m	263,30 /m	1579,80 /bar	■ min 72 m	241,30 /m	1447,80 /bar
		*IB-8500-G (12+12)	GR	3000 mm	■ min 30 m	275,00 /m	825,00 /bar	■ min 72 m	263,70 /m	791,10 /bar
				6000 mm	■ min 30 m	285,70 /m	1714,20 /bar	■ min 72 m	263,70 /m	1582,20 /bar
		IB-8001	AN	3000 mm	■ min 30 m	11,90 /m	35,70 /bar	■ min 72 m	10,77 /m	32,30 /bar
				6000 mm	■ min 30 m	8,05 /m	48,30 /bar	■ min 72 m	7,45 /m	44,70 /bar
IB-8051	AN	3000 mm	■ min 30 m	14,00 /m	42,00 /bar	■ min 72 m	12,77 /m	38,30 /bar		
		6000 mm	■ min 30 m	9,88 /m	59,30 /bar	■ min 72 m	9,28 /m	55,70 /bar		

- Confezioni industriali
- Industrial packaging
- Industrieverpackungen
- * Senza velle
- Without cover profiles
- Ohne Abdeckungen

POS.	PROD.	ART.	FIN.	MIS.	Q.TÀ	EURO	Q.TÀ	EURO	
B-5500 MAXIMA STADIUM		▶ BALAUSTR E PENSILINE 50							
H.16		B-5500 (12+12)	3000 mm	1 set		404,00 /m		1212,00 /bar	
		IB-5500 (12+12)	3000 mm	■ min 30 m		357,30 /m	1071,90 /bar	■ min 72 m	345,00 /m 1035,00 /bar
B-5600 MAXIMA STADIUM TRIPLO VETRO		▶ BALAUSTR E PENSILINE 50							
H.17		B-5600 (10+10)	3000 mm	1 set		422,00 /m		1266,00 /bar	
		IB-5600 (10+10)	3000 mm	■ min 30 m		379,30 /m	1137,90 /bar	■ min 72 m	367,50 /m 1102,50 /bar
B-1100		▶ BALAUSTR E PENSILINE 49							
H.18		B-1100 (8+8)	3000 mm	1 set		234,50 /m		703,50 /bar	
		B-1100 (10+10)	3000 mm	1 set		232,00 /m		696,00 /bar	
		IB-1100 (8+8)	3000 mm	■ min 30 m		206,00 /m	618,00 /bar	■ min 72 m	206,00 /m 618,00 /bar
		IB-1100 (10+10)	3000 mm	■ min 30 m		203,30 /m	609,90 /bar	■ min 72 m	203,30 /m 609,90 /bar
B-1101		▶ BALAUSTR E PENSILINE 56							
H.19		B-1101 (8+8)	3000 mm	1 set		263,70 /m		791,10 /bar	
		B-1101 (10+10)	3000 mm	1 set		261,00 /m		783,00 /bar	
		IB-1101 (8+8)	3000 mm	■ min 30 m		248,70 /m	746,10 /bar	■ min 72 m	248,70 /m 746,10 /bar
		IB-1101 (10+10)	3000 mm	■ min 30 m		246,30 /m	738,90 /bar	■ min 72 m	246,30 /m 738,90 /bar

POS.	PROD.	ART.	FIN.	MIS.	Q.TÀ	EURO	Q.TÀ	EURO
------	-------	------	------	------	------	------	------	------

B-8300 CMR		▶ BALAUSTR E PENSILINE 54								
H.20		B-8300 (8+8)	AN	3000 mm	1 set	291,70 /m			875,10 /bar	
		B-8300 (10+10)	AN	3000 mm	1 set	288,30 /m			864,90 /bar	
		B-8300 (12+12)	AN	3000 mm	1 set	300,00 /m			900,00 /bar	
		*B-8300-G (8+8)	GR	3000 mm	1 set	265,50 /m			796,50 /bar	
			GR	6000 mm	1 set	265,50 /m			1593,00 /bar	
		*B-8300-G (10+10)	GR	3000 mm	1 set	261,70 /m			785,10 /bar	
			GR	6000 mm	1 set	261,70 /m			1570,20 /bar	
		*B-8300-G (12+12)	GR	3000 mm	1 set	284,70 /m			854,10 /bar	
			GR	6000 mm	1 set	284,70 /m			1708,20 /bar	
		IB-8300 (8+8)	AN	3000 mm	■ min 30 m	268,30 /m	804,90 /bar	■ min 72 m	256,30 /m	768,90 /bar
		IB-8300 (10+10)	AN	3000 mm	■ min 30 m	264,70 /m	794,10 /bar	■ min 72 m	252,70 /m	758,10 /bar
		IB-8300 (12+12)	AN	3000 mm	■ min 30 m	276,30 /m	828,90 /bar	■ min 72 m	264,70 /m	794,10 /bar
		*IB-8300-G (8+8)	GR	3000 mm	■ min 30 m	233,00 /m	699,00 /bar	■ min 72 m	221,00 /m	663,00 /bar
			GR	6000 mm	■ min 30 m	243,50 /m	1461,00 /bar	■ min 72 m	221,00 /m	1326,00 /bar
*IB-8300-G (10+10)	GR	3000 mm	■ min 30 m	229,00 /m	687,00 /bar	■ min 72 m	217,30 /m	651,90 /bar		
	GR	6000 mm	■ min 30 m	239,70 /m	1438,20 /bar	■ min 72 m	217,30 /m	1303,80 /bar		
*IB-8300-G (12+12)	GR	3000 mm	■ min 30 m	241,30 /m	723,90 /bar	■ min 72 m	229,00 /m	687,00 /bar		
	GR	6000 mm	■ min 30 m	252,00 /m	1512,00 /bar	■ min 72 m	229,00 /m	1374,00 /bar		

B-4050 MAXIMA JOLLY PACK SINGOLO		▶ BALAUSTR E PENSILINE 60								
H.21		B-4050 (8+8)	AN	3000 mm	1 set	213,30 /m			639,90 /bar	
		B-4050 (10+10)	AN	3000 mm	1 set	209,50 /m			628,50 /bar	
		B-4050 (12+12)	AN	3000 mm	1 set	249,70 /m			749,10 /bar	
		IB-4050 (8+8)	AN	3000 mm	■ min 30 m	211,50 /m	634,50 /bar	■ min 72 m	199,70 /m	599,10 /bar
		IB-4050 (10+10)	AN	3000 mm	■ min 30 m	208,70 /m	626,10 /bar	■ min 72 m	197,00 /m	591,00 /bar
		IB-4050 (12+12)	AN	3000 mm	■ min 30 m	231,30 /m	693,90 /bar	■ min 72 m	219,50 /m	658,50 /bar

B-2060		▶ BALAUSTR E PENSILINE 61								
H.22		B-2060 (8+8)	AN	3000 mm	1 set	251,00 191,00 /m			753,00 573,00 /bar	
		B-2060 (10+10)	AN	3000 mm	1 set	279,00 209,50 /m			837,00 628,50 /bar	
		IB-2060 (8+8)	AN	3000 mm	■ min 30 m	219,50 180,30 /m	540,90 /bar	■ min 72 m	219,50 180,30 /m	540,90 /bar
		IB-2060 (10+10)	AN	3000 mm	■ min 30 m	239,70 197,30 /m	591,90 /bar	■ min 72 m	239,70 197,30 /m	591,90 /bar
		<i>FINE SERIE END OF SERIES AUSLAUFMODELL</i>								

- Confezioni industriali
- Industrial packaging
- Industrieverpackungen
- * Senza vellete
- * Without cover profiles
- * Ohne Abdeckungen

POS.	PROD.	ART.	FIN.	MIS.	Q.TÀ	EURO	Q.TÀ	EURO
------	-------	------	------	------	------	------	------	------

H.23								
------	--	--	--	--	--	--	--	--

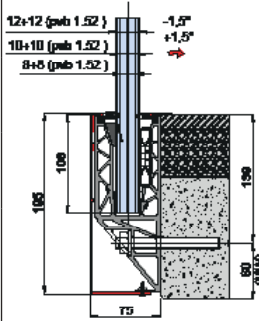
B-8200 CMR

B-8200 (8+8)	AN	3000 mm	1 set	352,00 /m			1056,00 /bar	
B-8200 (10+10)	AN	3000 mm	1 set	349,70 /m			1049,10 /bar	
B-8200 (12+12)	AN	3000 mm	1 set	360,30 /m			1080,90 /bar	
*B-8200-G (8+8)	GR	3000 mm	1 set	269,30 /m			807,90 /bar	
*B-8200-G (10+10)	GR	3000 mm	1 set	267,00 /m			801,00 /bar	
*B-8200-G (12+12)	GR	3000 mm	1 set	279,00 /m			837,00 /bar	

H.23.1

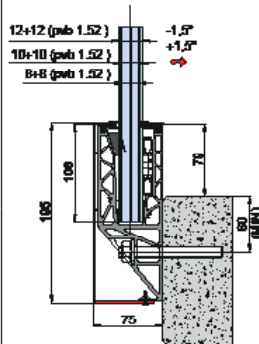

IB-8200 (8+8)	AN	3000 mm	■ min 30 m	325,00 /m	975,00 /bar	■ min 72 m	313,00 /m	939,00 /bar
IB-8200 (10+10)	AN	3000 mm	■ min 30 m	322,50 /m	967,50 /bar	■ min 72 m	310,70 /m	932,10 /bar
IB-8200 (12+12)	AN	3000 mm	■ min 30 m	343,50 /m	1030,50 /bar	■ min 72 m	332,30 /m	996,90 /bar
*IB-8200-G (8+8)	GR	3000 mm	■ min 30 m	254,00 /m	762,00 /bar	■ min 72 m	242,30 /m	726,90 /bar
*IB-8200-G (10+10)	GR	3000 mm	■ min 30 m	251,50 /m	754,50 /bar	■ min 72 m	239,70 /m	719,10 /bar
*IB-8200-G (12+12)	GR	3000 mm	■ min 30 m	259,70 /m	779,10 /bar	■ min 72 m	271,50 /m	814,50 /bar

B-7550-G SMARTONE

▶ BALAUSTR E PENSILINE 32

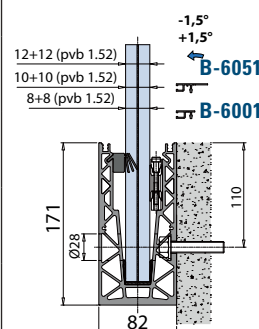

H.24

*B-7550-G (8+8)	GR	3000 mm	1 set	380,00 /m			1140,00 /bar	
*B-7550-G (10+10)	GR	3000 mm	1 set	376,30 /m			1128,90 /bar	
*B-7550-G (12+12)	GR	3000 mm	1 set	403,50 /m			1210,50 /bar	
*B-7550-G-CH-12	GR	3000 mm	1 set	380,00 /m			1140,00 /bar	
*IB-7550-G (8+8)	GR	3000 mm	■ min 30 m	367,70 /m	1103,10 /bar	■ min 72 m	356,00 /bar	1068,00 /bar
*IB-7550-G (10+10)	GR	3000 mm	■ min 30 m	364,30 /m	1092,90 /bar	■ min 72 m	352,30 /bar	1056,90 /bar
*IB-7550-G (12+12)	GR	3000 mm	■ min 30 m	384,30 /m	1152,90 /bar	■ min 72 m	372,50 /bar	1117,50 /bar
*IB-7550-G-CH-12	GR	3000 mm	■ min 30 m	367,70 /m	1103,10 /bar	■ min 72 m	356,00 /bar	1068,00 /bar

POS.	PROD.	ART.	FIN.	MIS.	Q.TÀ	EURO	Q.TÀ	EURO		
B-8250-WN CMR CLIMB						▶ BALAUSTR E PENSILINE 78				
H.25		B-8250-WN (8+8)	AN	3000 mm	1 set	297,50 /m		892,50 /bar		
		B-8250-WN (10+10)	AN	3000 mm	1 set	295,00 /m		885,00 /bar		
		B-8250-WN (12+12)	AN	3000 mm	1 set	304,70 /m		914,10 /bar		
		*B-8250-WN-G (8+8)	GR	3000 mm	1 set	227,00 /m		681,00 /bar		
		*B-8250-WN-G (10+10)	GR	3000 mm	1 set	224,30 /m		672,90 /bar		
		*B-8250-WN-G (12+12)	GR	3000 mm	1 set	236,00 /m		708,00 /bar		
		IB-8250-WN (8+8)	AN	3000 mm	■ min 30 m	275,00 /m	825,00 /bar	■ min 72 m	263,70 /m	791,10 /bar
		IB-8250-WN (10+10)	AN	3000 mm	■ min 30 m	271,50 /m	814,50 /bar	■ min 72 m	259,70 /m	779,10 /bar
		IB-8250-WN (12+12)	AN	3000 mm	■ min 30 m	293,00 /m	879,00 /bar	■ min 72 m	281,00 /m	843,00 /bar
		*IB-8250-WN-G (8+8)	GR	3000 mm	■ min 30 m	211,50 /m	634,50 /bar	■ min 72 m	199,70 /m	599,10 /bar
		*IB-8250-WN-G (10+10)	GR	3000 mm	■ min 30 m	208,00 /m	624,00 /bar	■ min 72 m	196,30 /m	588,90 /bar
		*IB-8250-WN-G (12+12)	GR	3000 mm	■ min 30 m	228,00 /m	684,00 /bar	■ min 72 m	216,30 /m	648,90 /bar
B-8260 CMR CLIMB						▶ BALAUSTR E PENSILINE 78				
H.26		B-8260-WN (8+8)	AN	3000 mm	1 set	305,70 /m		917,10 /bar		
		B-8260-WN (10+10)	AN	3000 mm	1 set	303,50 /m		910,50 /bar		
		B-8260-WN (12+12)	AN	3000 mm	1 set	313,00 /m		939,00 /bar		
		*B-8260-WN-G (8+8)	GR	3000 mm	1 set	235,00 /m		705,00 /bar		
		*B-8260-WN-G (10+10)	GR	3000 mm	1 set	233,00 /m		699,00 /bar		
		*B-8260-WN-G (12+12)	GR	3000 mm	1 set	244,50 /m		733,50 /bar		
		IB-8260-WN (8+8)	AN	3000 mm	■ min 30 m	283,30 /m	849,90 /bar	■ min 72 m	271,50 /m	814,50 /bar
		IB-8260-WN (10+10)	AN	3000 mm	■ min 30 m	280,00 /m	840,00 /bar	■ min 72 m	268,30 /m	804,90 /bar
		IB-8260-WN (12+12)	AN	3000 mm	■ min 30 m	301,30 /m	903,90 /bar	■ min 72 m	289,30 /m	867,90 /bar
		*IB-8260-WN-G (8+8)	GR	3000 mm	■ min 30 m	219,70 /m	659,10 /bar	■ min 72 m	208,00 /m	624,00 /bar
		*IB-8260-WN-G (10+10)	GR	3000 mm	■ min 30 m	216,30 /m	648,90 /bar	■ min 72 m	204,50 /m	613,50 /bar
		*IB-8260-WN-G (12+12)	GR	3000 mm	■ min 30 m	236,00 /m	708,00 /bar	■ min 72 m	224,30 /m	672,90 /bar

-
- Confezioni industriali
- Industrial packaging
- Industrieverpackungen
- *
 - Senza vellete
 - Without cover profiles
 - Ohne Abdeckungen

POS.	PROD.	ART.	FIN.	MIS.	Q.TÀ	EURO	Q.TÀ	EURO
------	-------	------	------	------	------	------	------	------

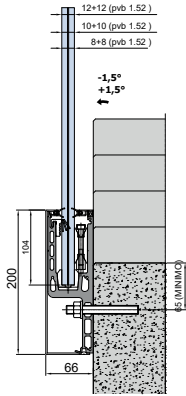
B-6220 LUXOR STAIRS
► BALAUSTRÉ E PENSILINE 82
H.27

B-6220 (8+8)	AN	3000 mm	1 set	395,30 /m			1185,90 /bar	
	IXE	3000 mm	1 set	431,70 /m			1295,10 /bar	
B-6220 (10+10)	AN	3000 mm	1 set	391,70 /m			1175,10 /bar	
	IXE	3000 mm	1 set	428,00 /m			1284,00 /bar	
B-6220 (12+12)	AN	3000 mm	1 set	410,00 /m			1230,00 /bar	
	IXE	3000 mm	1 set	440,30 /m			1320,90 /bar	
IB-6220 (8+8)	AN	3000 mm	■ min 30 m	357,70 /m	1073,10 /bar	■ min 72 m	346,00 /m	1038,00 /bar
	IXE	3000 mm	■ min 30 m	376,00 /m	1128,00 /bar	■ min 72 m	364,30 /m	1092,90 /bar
IB-6220 (10+10)	AN	3000 mm	■ min 30 m	355,00 /m	1065,00 /bar	■ min 72 m	343,30 /m	1029,90 /bar
	IXE	3000 mm	■ min 30 m	373,30 /m	1119,90 /bar	■ min 72 m	361,30 /m	1083,90 /bar
IB-6220 (12+12)	AN	3000 mm	■ min 30 m	373,30 /m	1119,90 /bar	■ min 72 m	361,30 /m	1083,90 /bar
	IXE	3000 mm	■ min 30 m	389,30 /m	1167,90 /bar	■ min 72 m	377,30 /m	1131,90 /bar

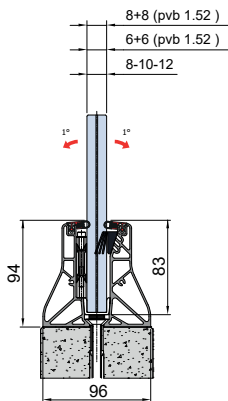
B-3600 MURETTO ANTISCAVALCAMENTO / LOW WALL / AUF ATTIKAMAUER
► BALAUSTRÉ 88
H.28

B-3600 (6+6)	AN	3000 mm	1 set	212,50 /m			637,50 /bar	
		6000 mm		212,50 /m			1275,00 /bar	
B-3600 (8+8)	AN	3000 mm	1 set	212,50 /m			637,50 /bar	
		6000 mm		212,50 /m			1275,00 /bar	
B-3600 (8)	AN	3000 mm	1 set	243,30 /m			729,90 /bar	
		6000 mm		243,30 /m			1459,80 /bar	
B-3600 (10)	AN	3000 mm	1 set	243,30 /m			729,90 /bar	
		6000 mm		243,30 /m			1459,80 /bar	
B-3600 (12)	AN	3000 mm	1 set	243,30 /m			729,90 /bar	
		6000 mm		243,30 /m			1459,80 /bar	
IB-3600 (6+6)	AN	3000 mm	■ min 30 m	189,00 /m	567,00 /bar	■ min 72 m	177,30 /m	531,90 /bar
		6000 mm		199,70 /m	1198,20 /bar		177,30 /m	1063,80 /bar
IB-3600 (8+8)	AN	3000 mm	■ min 30 m	189,00 /m	567,00 /bar	■ min 72 m	177,30 /m	531,90 /bar
		6000 mm		199,70 /m	1198,20 /bar		177,30 /m	1063,80 /bar
IB-3600 (8)	AN	3000 mm	■ min 30 m	242,00 /m	726,00 /bar	■ min 72 m	230,00 /m	690,00 /bar
		6000 mm		252,70 /m	1516,20 /bar		230,00 /m	1380,00 /bar
IB-3600 (10)	AN	3000 mm	■ min 30 m	242,00 /m	726,00 /bar	■ min 72 m	230,00 /m	690,00 /bar
		6000 mm		252,70 /m	1516,20 /bar		230,00 /m	1380,00 /bar
IB-3600 (12)	AN	3000 mm	■ min 30 m	242,00 /m	726,00 /bar	■ min 72 m	230,00 /m	690,00 /bar
		6000 mm		252,70 /m	1516,20 /bar		230,00 /m	1380,00 /bar

POS.	PROD.	ART.	FIN.	MIS.	Q.TÀ	EURO	Q.TÀ	EURO		
H.29										
B-3500-N MURETTO / LOW WALL / AUF ATTIKAMAUER						▶ BALAUSTR E PENSILINE 86				
H.30		B-3500-N (6+6)	AN	3000 mm	1 set	186,50 /m		559,50 /bar		
				6000 mm		186,50 /m		1119,00 /bar		
		B-3500-N (8+8)	AN	3000 mm	1 set	186,50 /m		559,50 /bar		
				6000 mm		186,50 /m		1119,00 /bar		
		B-3500-N (8)	AN	3000 mm	1 set	219,50 /m		658,50 /bar		
				6000 mm		219,50 /m		1317,00 /bar		
		B-3500-N (10)	AN	3000 mm	1 set	219,50 /m		658,50 /bar		
				6000 mm		219,50 /m		1317,00 /bar		
		B-3500-N (12)	AN	3000 mm	1 set	219,50 /m		658,50 /bar		
				6000 mm		219,50 /m		1317,00 /bar		
		IB-3500-N (6+6)	AN	3000 mm	■ min 30 m	172,00 /m	516,00 /bar	■ min 72 m	160,00 /m	480,00 /bar
				6000 mm		182,70 /m	1096,20 /bar		160,00 /m	960,00 /bar
		IB-3500-N (8+8)	AN	3000 mm	■ min 30 m	172,00 /m	516,00 /bar	■ min 72 m	160,00 /m	480,00 /bar
				6000 mm		182,70 /m	1096,20 /bar		160,00 /m	960,00 /bar
IB-3500-N (8)	AN	3000 mm	■ min 30 m	204,70 /m	614,10 /bar	■ min 72 m	193,00 /m	579,00 /bar		
		6000 mm		215,50 /m	1293,00 /bar		193,00 /m	1158,00 /bar		
IB-3500-N (10)	AN	3000 mm	■ min 30 m	204,70 /m	614,10 /bar	■ min 72 m	193,00 /m	579,00 /bar		
		6000 mm		215,50 /m	1293,00 /bar		193,00 /m	1158,00 /bar		
IB-3500-N (12)	AN	3000 mm	■ min 30 m	204,70 /m	614,10 /bar	■ min 72 m	193,00 /m	579,00 /bar		
		6000 mm		215,50 /m	1293,00 /bar		193,00 /m	1158,00 /bar		
H.31										





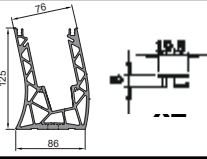
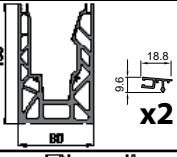
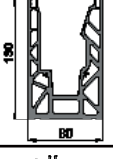
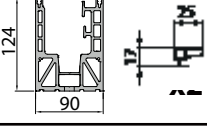
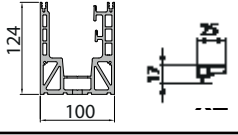
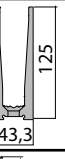
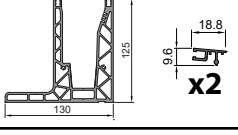
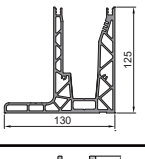
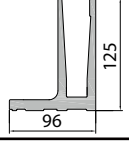
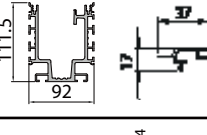
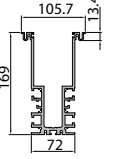

POS.	PROD.	ART.	FIN.	MIS.	Q.TÀ	EURO	EURO
------	-------	------	------	------	------	------	------

PROFILI / PROFILES / PROFILE
► BALAUSTR E PENSILINE 108





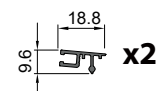
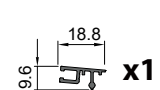
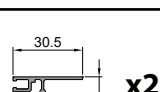
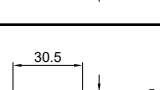
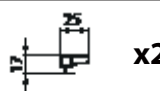
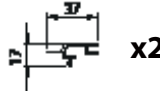

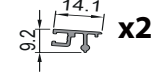
H.32		B-7500	AN	3000 mm		319,30/m	957,90 /pc
		B-7520	AN	125 mm		- /m	91,50 /pc
H.33		B-7500-G	GR	3000 mm		262,70/m	788,10 /pc
H.34		B-8000-WN	AN	3000 mm		197,00/m	591,00 /pc
			AN	6000 mm		197,00/m	1182,00 /pc
H.35		B-8000-WN-G	GR	3000 mm		170,00/m	510,00 /pc
			GR	6000 mm		170,00/m	1020,00 /pc
H.35.1		B-8700	AN	3000 mm		167,50/m	502,50 /pc
			AN	6000 mm		167,50/m	1005,00 /pc
H.35.2		B-8700-G	GR	3000 mm		141,70/m	425,10 /pc
			GR	6000 mm		141,70/m	850,20 /pc
H.36		B-6000	AN	3000 mm		215,30/m	645,90 /pc
			AN	6000 mm		215,30/m	1291,80 /pc
H.37		B-6000-G	GR	3000 mm		175,50/m	526,50 /pc
			GR	6000 mm		175,50/m	1053,00 /pc
H.38							
H.39							
H.40							
H.41		B-7120	AN	250 mm		- /m	75,70 /pc
H.42							
H.43							
H.44							
H.45							

POS.	PROD.	ART.	FIN.	MIS.	Q.TÀ	EURO	EURO
H.46		B-2100	AN	3000 mm		243,30 /m	729,90 /pc
H.46.1		B-8500	AN	3000 mm		261,00 /m	783,00 /pc
			AN	6000 mm		261,00 /m	1566,00 /pc
H.46.2		B-8500-G	GR	3000 mm		213,50 /m	640,50 /pc
			GR	6000 mm		213,50 /m	1281,00 /pc
H.47		B-5500	AN	3000 mm		338,30 /m	1014,90 /pc
H.48		B-5600	AN	3000 mm		357,00 /m	1071,00 /pc
H.49		B-1100	AN	3000 mm		209,00 /m	627,00 /pc
H.50		B-8300	AN	3000 mm		214,00 /m	642,00 /pc
H.51		B-8300-G	GR	3000 mm		147,00 /m	441,00 /pc
			GR	6000 mm		147,00 /m	882,00 /pc
H.52		B-1101	AN	3000 mm		240,50 /m	721,50 /pc
H.53		B-4050	AN	3000 mm		150,50 /m	451,50 /pc
H.54		B-2060 FINE SERIE END OF SERIES AUSLAUFMODELL	AN	3000 mm		195,00 /m	585,00 /pc
H.55							

POS.	PROD.	ART.	FIN.	MIS.	Q.TÀ	EURO	EURO
H.55.1		B-8200-G	GR	3000 mm		203,00 /m	609,00 /pc
H.56		B-7550-G	GR	3000 mm		285,00 /m	855,00 /pc
H.57		B-8250-WN-G	GR	3000 mm		159,30 /m	477,90 /pc
H.58							
H.59		B-6220	AN	3000 mm		251,50 /m	754,50 /pc
H.60		B-3600	AN	3000 mm		152,30 /m	456,90 /pc
			AN	6000 mm		152,30 /m	913,80 /pc
H.61							
H.62		B-3500-N	AN	3000 mm		137,50 /m	412,50 /pc
			AN	6000 mm		137,50 /m	825,00 /pc
H.63		UB-120	AG	120 mm			124,30 /pc
			GR	120 mm			106,30 /pc
			AG	120 mm	■ min 40 pcs		112,50 /pc
			GR	120 mm	■ min 40 pcs		92,50 /pc
H.63.1		UB-220	AG	220 mm			192,70 /pc
			GR	220 mm			164,30 /pc
			AG	220 mm	■ min 40 pcs		181,00 /pc
			GR	220 mm	■ min 40 pcs		151,30 /pc
H.63.2		UB-122	AN	3000 mm	4 pc		141,70 /set
				6000 mm	4 pc		221,00 /set
			AN	3000 mm	■ min 14 pcs		28,70 /pc
				6000 mm	■ min 14 pcs		43,00 /pc

POS.	PROD.	ART.	FIN.	MIS.	Q.TÀ	EURO	EURO
VELETTE / COVER PROFILES / ABDECKUNGEN							
► BALAUSTR E PENSILINE 112							
H.64		B-6001-CF2 • For profiles: B-7500 / B-7500-G / B-6000 B-6000-G / B-2100 / B-7550-G B-6220	AN	3000 mm		17,00 (x2) /m	102,00 /set
			AN	6000 mm		11,88 (x2) /m	142,50 /set
H.65		IB-6001 • For profiles: B-7500 / B-7500-G / B-6000 B-6000-G / B-2100 / B-7550-G B-6220	AN	3000 mm	■ min 30 m	12,23 /m	36,70 /pc
					■ min 72 m	11,10 /m	33,30 /pc
			AN	6000 mm	■ min 30 m	8,00 /m	48,00 /pc
					■ min 72 m	7,42 /m	44,50 /pc
H.66		B-6051-CF2 • For profiles: B-7500 / B-7500-G / B-6000 B-6000-G / B-2100 / B-7550-G	AN	3000 mm		19,17 (x2) /m	115,00 /set
			AN	6000 mm		13,86 (x2) /m	166,30 /set
H.67		IB-6051 • For profiles: B-7500 / B-7500-G / B-6000 B-6000-G / B-2100 / B-7550-G	AN	3000 mm	■ min 30 m	14,00 /m	42,00 /pc
					■ min 72 m	12,77 /m	38,30 /pc
			AN	6000 mm	■ min 30 m	9,95 /m	59,70 /pc
					■ min 72 m	9,38 /m	56,30 /pc
H.68		B-8001-CF2 • For profile: B-8000 / B-8000-G / B-8700 / B-8700-G / B-8300 / B-8300-G B-8250-G / B-8200 / B-8500 B-8500-G	AN	3000 mm		15,00 (x2) /m	90,00 /set
			AN	6000 mm		10,50 (x2) /m	126,00 /set
H.69		IB-8001 • For profile: B-8000 / B-8000-G / B-8700 / B-8700-G / B-8300 / B-8300-G B-8250-G / B-8200 / B-8500 B-8500-G	AN	3000 mm	■ min 30 m	11,90 /m	35,70 /pc
					■ min 72 m	10,77 /m	32,30 /pc
			AN	6000 mm	■ min 30 m	8,05 /m	48,30 /pc
					■ min 72 m	7,45 /m	44,70 /pc
H.70		B-8051-CF2 • For profile: B-8000 / B-8000-G / B-8700 / B-8700-G / B-8300 / B-8300-G B-8250-G / B-8200 / B-8500 B-8500-G	AN	3000 mm		16,88 (x2) /m	101,30 /set
			AN	6000 mm		12,29 (x2) /m	147,50 /set
H.71		IB-8051 • For profile: B-8000 / B-8000-G / B-8700 / B-8700-G / B-8300 / B-8300-G B-8250-G / B-8200 / B-8500 B-8500-G	AN	3000 mm	■ min 30 m	14,00 /m	42,00 /pc
					■ min 72 m	12,77 /m	38,30 /pc
			AN	6000 mm	■ min 30 m	9,88 /m	59,30 /pc
					■ min 72 m	9,28 /m	55,70 /pc
H.72							
H.73							
H.74							
H.75							
H.76							
H.77							
H.78		B-2001-CF2 • For profiles: B-5600 / B-5500	AN	3000 mm		18,25 (x2) /m	109,50 /set
H.79		B-2051-CF2 • For profile: B-4050	AN	3000 mm		18,25 (x2) /m	109,50 /set
H.80		IB-2051 • For profile: B-4050	AN	3000 mm	■ min 72 m	16,23 /m	48,70 /pc
H.81		B-3501-CF2 • For profiles: B-3500-N / B-3600	AN	3000 mm		13,50 (x2) /m	81,00 /set
			AN	6000 mm		8,92 (x2) /m	107,00 /set

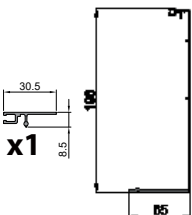
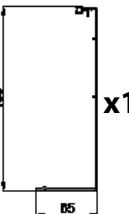
- Confezioni industriali
- Industrial packaging
- Industrieverpackungen
- * Senza velette
- Without cover profiles
- Ohne Abdeckungen
- *** Prezzo su richiesta
- Price on request
- Preis auf Anfrage

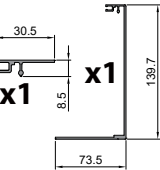
POS.	PROD.	ART.	FIN.	MIS.	Q.TÀ	EURO	EURO
H.82	 x1	IB-3501 • For profiles: B-3500-N / B-3600	AN	3000 mm	■ min 30 m	9,77 /m	29,30 /pc
					■ min 72 m	8,67 /m	26,00 /pc
			AN	6000 mm	■ min 30 m	6,38 /m	38,30 /pc
					■ min 72 m	5,83 /m	35,00 /pc
H.83	 x2	B-3551-CF2 • For profiles: B-3500-N	AN	3000 mm		15,58 (x2) /m	93,50 /set
			AN	6000 mm		11,06 (x2) /m	132,70 /set
H.84	 x1	IB-3551 • For profile: B-3500-N	AN	3000 mm	■ min 30 m	12,10 /m	36,30 /pc
					■ min 72 m	10,90 /m	32,70 /pc
			AN	6000 mm	■ min 30 m	8,45 /m	50,70 /pc
					■ min 72 m	7,92 /m	47,50 /pc
H.85							
H.86	 x1	IB-6201 • For profiles: B-6220	AN	3000 mm	■ min 30 m	64,10 /m	192,30 /pc
					■ min 72 m	63,00 /m	189,00 /pc
			AN	6000 mm	■ min 30 m	58,22 /m	349,30 /pc
					■ min 72 m	57,67 /m	346,00 /pc
H.86.1	 x1	B-8201-CF2 • For profiles: B-8200-G	AN	3000 mm		99,17/m	297,50/set
			AN	6000 mm		94,00/m	564,00/set
H.86.2	 x1	IB-8201 • For profiles: B-8200-G	AN	3000 mm	■ min 30 m	66,77 /m	200,30 /pc
					■ min 72 m	65,67 /m	197,00 /pc
			AN	6000 mm	■ min 30 m	65,12 /m	390,70 /pc
					■ min 72 m	64,58 /m	387,50 /pc
H.87	 x2	B-6121-CF2 • For profile: B-6000-G	AN	3000 mm		48,72 (x2)/m	292,30/set
			AN	6000 mm		39,38 (x2)/m	472,50/set
			IXE	3000 mm		53,83 (x2)/m	323,00/set
			IXE	6000 mm		44,78 (x2)/m	537,30/set
H.88	 1	IB-6121 • For profile: B-6000-G	AN	3000 mm	■ min 30 m	29,77 /m	89,30 /pc
					■ min 72 m	28,67 /m	86,00 /pc
			AN	6000 mm	■ min 30 m	27,25 /m	163,50 /pc
					■ min 72 m	26,67 /m	160,00 /pc
H.89	 x1	B-8251-CF2 • For profile: B-8250-G	AN	3000 mm		97,10/m	291,30/set
			IXE	3000 mm		137,90/m	413,70/set

POS.	PROD.	ART.	FIN.	MIS.	Q.TÀ	EURO	EURO	
H.90		IB-8251 • For profile: B-8250-G	AN	3000 mm	■ min 30 m	67,43 /m	202,30 /pc	
					■ min 72 m	66,00 /m	198,00 /pc	
			AN	6000 mm	■ min 30 m	65,38 /m	392,30 /pc	
					■ min 72 m	64,62 /m	387,70 /pc	
			IX	3000 mm	■ min 30 m	89,57 /m	268,70 /pc	
					■ min 72 m	88,10 /m	264,30 /pc	
		IX	6000 mm	■ min 30 m	83,17 /m	499,00 /pc		
				■ min 72 m	82,42 /m	494,50 /pc		
H.91		B-8121-CF2 • For profile: B-8000-G	AN	3000 mm		44,58 (x2)/m	267,50 /set	
			AN	6000 mm		35,98 (x2)/m	431,70 /set	
			IXE	3000 mm		59,22 (x2)/m	355,30 /set	
			IXE	6000 mm		53,31 (x2)/m	639,70 /set	
H.92		IB-8121 • For profile: B-8000-G	AN	3000 mm	■ min 30 m	31,50 /m	94,50 /pc	
					■ min 72 m	31,33 /m	94,00 /pc	
			AN	6000 mm	■ min 30 m	28,12 /m	168,70 /pc	
					■ min 72 m	27,38 /m	164,30 /pc	
			IX	3000 mm	■ min 30 m	47,23 /m	141,70 /pc	
					■ min 72 m	45,00 /m	135,00 /pc	
		IX	6000 mm	■ min 30 m	45,22 /m	271,30 /pc		
				■ min 72 m	44,58 /m	267,50 /pc		
H.92.1		B-8721-CF2 • For profile: B-8700-G	AN	3000 mm		41,22 (x2)/m	247,30 /set	
			AN	6000 mm		33,00 (x2)/m	396,00 /set	
			BI	3000 mm		51,92 (x2)/m	311,50 /set	
			BI	6000 mm		44,78 (x2)/m	537,30 /set	
H.92.2		IB-8721 • For profile: B-8700-G	AN	3000 mm	■ min 30 m	29,67 /m	89,00 /pc	
					■ min 72 m	27,83 /m	83,50 /pc	
			AN	6000 mm	■ min 30 m	27,67 /m	166,00 /pc	
					■ min 72 m	26,75 /m	160,50 /pc	
			BI	3000 mm	■ min 30 m	41,43 /m	124,30 /pc	
					■ min 72 m	39,67 /m	119,00 /pc	
		BI	6000 mm	■ min 30 m	40,33 /m	242,00 /pc		
				■ min 72 m	39,42 /m	236,50 /pc		
H.93 H.94		B-8061 • Velella con sede per cartongesso o lamiera a cura del cliente • Cover profile for plasterboard or other profiles by the customer • Abdeckung für Gipskarton oder andere Profile bauseitig	AN	3000 mm		28,90/m	86,70 /pc	
			AN	6000 mm		21,22/m	127,30 /pc	
			IB-8061	AN	3000 mm	■ min 30 m	21,77 /m	65,30 /pc
						■ min 72 m	19,57 /m	58,70 /pc
				AN	6000 mm	■ min 30 m	18,75 /m	112,50 /pc
						■ min 72 m	17,62 /m	105,70 /pc
H.95		CLIPS • For cover profiles: B-6001 / B-6051 / B-6601 / B-6651 B-2001 / B-2051 / B-6251 / B-6201 B-6121				24,50 / set		
H.96		CLIP-CMR • For cover profiles: B-8001 / B-8051 / B-8251 B-8121 / B-3501 / B-8061				28,00 / set		

- Confezioni industriali
- Industrial packaging
- Industrieverpackungen
- * Senza velle
- * Without cover profiles
- * Ohne Abdeckungen
- *** Prezzo su richiesta
- *** Price on request
- *** Preis auf Anfrage

POS.	PROD.	ART.	FIN.	EURO	POS.	PROD.	ART.	FIN.	EURO
------	-------	------	------	------	------	-------	------	------	------

TAPPI FINALI / ENDCAPS / ENDKAPPEN ▶ BALAUSTR E PENSILINE 114

H.97		B-7506 • For profiles: B-7500 B-7500-G	AN	41,70 /pc
H.98		B-7526 • For profile: B-7520	AN	45,30 /pc
		IB-7526	■ min 20 pcs	17,30 /pc
H.99		B-8006-WN • For profile: B-8000	AN	34,00 /pc
		IB-8006-WN	■ min 20 pcs	15,30 /pc
H.100				
H.101		B-8306-N • For profiles: B-8300 B-8300-G	AN	34,70 /pc
		IB-8306-N	■ min 20 pcs	15,70 /pc
H.102		B-8256 • For profile: B-8250-G B-8260-G	AN	32,50 /pc
		IB-8256	■ min 20 pcs	16,30 /pc
H.103		B-8126 • For profile: B-8000-G + B-8121-CF2	AN	32,50 /pc
		IB-8126	■ min 20 pcs	16,30 /pc
H.103.1		B-8706 • For profile: B-8700	AN	32,50 /pc
		IB-8706	■ min 20 pcs	16,30 /pc
H.104		B-6006-N • For profile: B-6000	AN	34,00 /pc
		IB-6006-N	■ min 20 pcs	15,30 /pc
H.105		B-6126-N • For profile: B-6000-G + B-6121-CF2	AN	34,00 /pc
		IB-6126-N	■ min 20 pcs	16,30 /pc
H.106				
H.107		B-7126 • For profiles: B-7120 B-7220	AN	28,00 /pc
		IB-7126	■ min 20 pcs	16,30 /pc
H.108				
H.109				

H.110		B-5506 • For profile: B-5500	AN	34,00 /pc
H.111		B-5606 • For profile: B-5600	AN	34,00 /pc
H.112				
H.113		B-2106 • For profile: B-2100	AN	37,00 /pc
H.114		UB-126 • For profiles: UB-120 UB-220	AN	13,50 /pc
		IUB-126	■ min 80 pcs	9,00 /pc
H.115				
H.116		B-1104 • For profile: B-1100	AN	29,50 /pc
H.117		B-1101-TAPPO • For profile: B-1101	AN	29,50 /pc
H.117.1				
H.118		B-8206 • For profile: B-8200	AN	37,00 /pc
		IB-8206	■ min 20 pcs	16,30 /pc
H.119		B-3606 • For profile: B-3600	AN	24,50 /pc
		IB-3606	■ min 20 pcs	10,70 /pc
H.120		B-3506-N • For profile: B-3500-N	AN	23,00 /pc
		IB-3506-N	■ min 20 pcs	10,30 /pc
H.121				
H.122		B-6226 • For profile: B-6220	AN	37,00 /pc
		IB-6226	■ min 20 pcs	16,30 /pc

POS.	PROD.	ART.	EURO
------	-------	------	------

KIT COMPLETI CON MORSETTI E GUARNIZIONI

► BALAUSTR E PENSILINE 117

KIT COMPLETE WITH CLAMPS AND GASKETS / KIT KOMPLETT MIT KLEMMEN UND DICHTINGEN

H.123		B-SET-CMR-8 (8+8) • For profiles: B-8300 / B-8300-G	241,00/set
		B-SET-CMR-10 (10+10) • For profiles: B-8300 / B-8300-G	235,50/set
H.123.1		B-SET-CMR-N-8 (8+8) • For profiles: B-8000 / B-8000-G / B-8200-G / B-8250-G B-8500 / B-8500-G	241,00/set
		B-SET-CMR-N-10 (10+10) • For profiles: B-8000 / B-8000-G / B-8700 / B-8700-G / B-8200-G B-8250-G / B-8500 / B-8500-G	235,50/set
		B-SET-CMR-N-12 (12+12) • For profiles: B-8000 / B-8000-G / B-8700 / B-8700-G / B-8200-G B-8250-G / B-8500 / B-8500-G / B-8300 / B-8300-G	318,00/set
H.123.2		B-SET-8700-8 (8+8) • For profiles: B-8700 / B-8700-G	258,00/set
H.124		B-SET-SMART-8 (8+8) • For profiles: B-7500 / B-7500-G / B-6000 / B-6000-G / B-2100 B-7550-G	241,00/set
		B-SET-SMART-10 (10+10) • For profiles: B-7500 / B-7500-G / B-6000 / B-6000-G / B-2100 B-7550-G	232,30/set
		B-SET-SMART-12 (12+12) • For profiles: B-7500 / B-7500-G / B-6000 / B-6000-G / B-2100 B-7550-G	270,00/set
H.125			
H.126			
H.127		B-SET-LUX-8 (8+8) • For profiles: B-6220	173,30/set
		B-SET-LUX-10 (10+10) • For profiles: B-6220	164,70/set
		B-SET-LUX-12 (12+12) • For profiles: B-6220	203,70/set
H.128			
H.129			

- Confezioni industriali
- Industrial packaging
- Industrieverpackungen
- * Senza vellete
- * Without cover profiles
- * Ohne Abdeckungen
- *** Prezzo su richiesta
- *** Price on request
- *** Preis auf Anfrage

POS.	PROD.	ART.	EURO
H.130			
H.131		B-SET-7120-8 (8+8) • For system: B-7120	94,50/set
		B-SET-7120-10 (10+10) • For system: B-7120	92,00/set
H.132		B-SET-7220-8 (8+8) • For system: B-7220	106,00/set
		B-SET-7220-10 (10+10) • For system: B-7220	103,50/set
H.133		B-SET-7520-8 (8+8) • For profile: B-7520	94,50/set
		B-SET-7520-10 (10+10) • For profile: B-7520	92,00/set
H.134			
H.135		KIT SMARTONE 2 • For profile: B-6000 / B-6000-G / B-2100 / B-7500 B-7500-G / B-7550-G	44,00/set
H.136		B-SET-MAX-8 (8+8) • For profiles: B-5500 / B-4050	219,50/set
		B-SET-MAX-10 (10+10) • For profiles: B-5500 / B-4050	219,50/set
		B-SET-MAX-12 (12+12) • For profiles: B-5500 / B-4050	305,70/set
H.137			
H.138			

POS.	PROD.	ART.	EURO
H.139	<p>B-8011-12 (8+8) B-8011-10 (6+6 - 12 - 10 - 8) B-3508 B-3602 CLIP-CMR B-1044-F (8+8) B-3604-13.52 (6+6) B-3604-12 B-3604-10 / B-3604-8</p>	B-SET-3600-6 (6+6) • For profile: B-3600	201,00/set
		B-SET-3600-8 (8+8) • For profile: B-3600	193,00/set
H.140	<p>B-8011-12 (8+8) B-8011-10 (6+6 - 12 - 10 - 8) B-3508 CLIP-CMR B-1044-F (8+8) B-3604-13.52 (6+6) B-3604-12 B-3604-10 / B-3604-8 B-3502 (8+8 / 6+6) B-3503 (12 / 10 / 8)</p>	B-SET-3500-N-6 (6+6) • For profile: B-3500-N	171,00/set
		B-SET-3500-N-8 (8+8) • For profile: B-3500-N	161,00/set
H.141	<p>UB-7004 (8+8) UB-7002 (10+10) UB-126 UB-121 B-6008 UB-2004 (8+8) UB-2005 (10+10)</p>	UB-SET-120-8 • For profile: UB-120	78,00/set
		UB-SET-120-10 • For profile: UB-120	77,00/set
H.141.1	<p>UB-7006 (8+8) UB-7005 (10+10) UB-126 UB-221 B-6008 UB-2004 (8+8) UB-2005 (10+10)</p>	UB-SET-220-8 • For profile: UB-220	100,30/set
		UB-SET-220-10 • For profile: UB-220	97,00/set
H.142	<p>B-2008 B-4101 CLIPS B-2004 / B-2005</p>	B-SET-JOLLY-8 (8+8) • For profiles: B-2060	321,30/set
		B-SET-JOLLY-10 (10+10) • For profiles: B-2060	310,00/set
		B-SET-JOLLY-12 (12+12) • For profiles: B-2060	458,70/set
H.143		B-1102 (8+8) • For profiles: B-1100 / B-1101	106,50/set
		B-1103 (10+10) • For profiles: B-1100 / B-1101	106,50/set

POS.	PROD.	ART.	EURO
------	-------	------	------

CUNEI / WEDGES / KEILEN

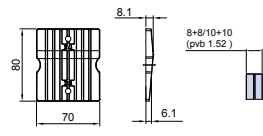
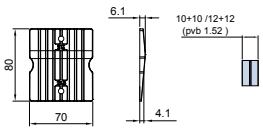
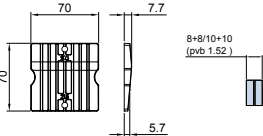
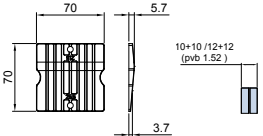
H.144		B-3009-8-10 • For profiles: B-7500 / B-6000 / B-2100 / B-5500 / B-5600 / B-8300 / B-4050 / B-6220 / B-7550-G	7,30/pc
H.145		B-3009-10-12 • For profiles: B-7500 / B-6000 / B-8000 / B-8700 / B-2100 / B-8200-G B-5500 / B-5600 / B-8300 / B-4050 / B-6220 / B-7550-G B-8250-G / B-8500	7,30/pc
H.146		B-6609-8-10 • For profiles: B-8000 / B-8700 / B-8200-G / B-8250-G / B-8500 B-7120	10,00/pc
H.147		B-6609-10-12 • For profiles: B-7120	10,00/pc

POS.	PROD.	ART.	EURO
------	-------	------	------

MORSETTI / JOLLYPACK

H.148		B-3208 <ul style="list-style-type: none"> For profiles: B-7500 / B-7500-G / B-7520 / B-6000 / B-6000-G / B-2100 / B-7550-G For glass 12+12 with profiles: B-8000 / B-8700 / B-8300 / B-8250-G / B-8200-G / B-8500 	33,50/pc
H.149		B-3008J	33,50/pc
H.150		B-6608 <ul style="list-style-type: none"> For profiles: B-7120 	25,30/pc
H.151		B-6008 <ul style="list-style-type: none"> For profiles: B-6220 / UB-120 / UB-220 	34,70/pc
		IB-6008 ■ min 40 pcs	17,00 /pc
H.152		B-8008 <ul style="list-style-type: none"> For glass 8+8 and 10+10 with profiles: B-8000 / B-8700 / B-8300 / B-8250-G / B-8200-G / B-8500 	38,00/pc
		IB-8008 ■ min 40 pcs	18,30 /pc
H.153		B-3508 <ul style="list-style-type: none"> For profile: B-3500-N / B-3600 	33,50/pc
H.154		B-2008-8 <ul style="list-style-type: none"> For glass 8+8 with profiles: B-5500 / B-5600 / B-2060 / B-4050 	38,50/pc
		B-2008-8 / B-2008-10 <ul style="list-style-type: none"> For glass 10+10 with profiles: B-5500 / B-5600 / B-2060 / B-4050 	38,50/pc
H.155		B-4508	28,00/pc
H.156		B-6009-CF6 <ul style="list-style-type: none"> Spacers for glass 8+8 with Jollypack: B-3208 / B-3008J / B-6608 / B-6008 / B-8008 / B-3508 	46,70/set

POS.	PROD.	ART.	Q.TÀ	EURO
------	-------	------	------	------

SUPPORTO VETRO / SUPPORT FOR GLASS / AUFLAGE FÜR GLAS











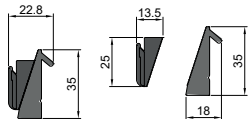



H.157		B-2004-F <ul style="list-style-type: none"> For glass 8+8 	9 pcs	27,70/set
		IB-2004-F ■ min 40 pcs		2,50/pc
		B-2005-F <ul style="list-style-type: none"> For glass 10+10 	9 pcs	27,70/set
		IB-2005-F ■ min 40 pcs		2,50/pc
		B-2006-F <ul style="list-style-type: none"> For glass 12+12 	9 pcs	27,70/set
		IB-2006-F ■ min 40 pcs		2,50/pc

- Confezioni industriali / Industrial packaging / Industrieverpackungen
- * Senza velle / Without cover profiles / Ohne Abdeckungen
- *** Prezzo su richiesta / Price on request / Preis auf Anfrage

POS.	PROD.	ART.	Q.TÀ	EURO
H.158		B-1044-F • Transparent for glass 8+8 For systems B-3500-N / B-3600	9 pcs	41,00/set
		B-3604-13,2 • Transparent for glass 6+6 For systems B-3500-N / B-3600	9 pcs	39,70/set
		B-3604-12 • Transparent for glass 12 For systems B-3500-N / B-3600	9 pcs	39,70/set
		B-3604-10 • Transparent for glass 10 For systems B-3500-N / B-3600	9 pcs	39,70/set
		B-3604-8 • Transparent for glass 8 For systems B-3500-N / B-3600	9 pcs	39,70/set
H.159		B-2007 8 • For glass 8+8 (transparent for LED)	9 pcs	40,70/set
		B-2007 10 • For glass 10+10 (transparent for LED)	9 pcs	40,70/set
		B-2007 SPECIAL • For glass 12+12 (transparent for LED)	9 pcs	40,70/set
H.160		B-3607 • Optional LED supports with profile B-3500-N for: B-1044-F / B-3604-13,2 / B-3604-12 / B-3604-10 B-3604-8	9 pcs	32,50/set
H.161				
H.162				
H.163		B-2004 SET • Support for glass 8+8 for profile: B-2500	6 pcs	16,30/set
H.164		B-4107-12 • Spacers for glass 12-12,76 mm (in addition to B-2004 SET)	12 pcs	49,30/set
H.165		B-4107-10 • Spacers for glass 10 mm (in addition to B-2004 SET)	12 pcs	49,30/set
H.166		B-4107-8 • Spacers for glass 8 mm (in addition to B-2004 SET)	12 pcs	49,30/set

POS.	PROD.	ART.	MIS.	Q.TÀ	EURO	EURO
------	-------	------	------	------	------	------

GUARNIZIONI APPOGGIO VETRO / SUPPORT GLASS GASKETS / DICHTUNGEN FÜR GLAS

H.167		B-7001 • For system: KIT SMARTONE 2	400 mm	3 pcs		54,30 /set
H.168		B-7002 • For glass 8+8 with profiles: B-7500 / B-6000 / B-7550-G / B-2100	400 mm	6 pcs		81,00/set
H.169		B-7003 • For glass 10+10 / 12+12 with profiles: B-7500 / B-6000 / B-7550-G / B-2100	400 mm	6 pcs		81,00/set
H.169.1		B-8003 • For profiles: B-8000 / B-8700 / B-8200-G / B-8250-G B-8500 • For glass 12+12 with profiles: B-8300	800 mm	3 pcs		83,00/set
H.170		B-8002 • For glass 8+8 and 10+10 with profiles: B-8300 / B-8300-G	800 mm	3 pcs		83,00/set
H.171		B-8102	800 mm	3 pcs		83,00/set
H.172		B-3102	400 mm	6 pcs		81,00/set
H.173		B-3103	400 mm	6 pcs		81,00 /set
H.174		B-4002 • For glass 8+8 with profiles: B-5500 / B-6220 / B-4050	3000 mm	1 pc	17,50/m	52,50/pc
H.175		B-4003 • For glass 10+10 with profiles: B-5500 / B-6220 / B-4050	3000 mm	1 pc	17,50/m	52,50/pc
H.176		B-4007 • For glass 12+12 with profiles: B-5500 / B-5600 / B-6220 / B-4050	3000 mm	1 pc	17,50/m	52,50/pc
H.177		B-3504	3000 mm	1 pc	15,57/m	46,70 /pc
H.178		B-3032	3000 mm	1 pc	17,50/m	52,50/pc
H.179		B-3031	3000 mm	1 pc	17,50/m	52,50/pc

- | | | |
|---|---|--|
| <ul style="list-style-type: none"> • Confezioni industriali • Industrial packaging • Industrieverpackungen | <ul style="list-style-type: none"> * Senza vellete * Without cover profiles * Ohne Abdeckungen | <ul style="list-style-type: none"> *** Prezzo su richiesta *** Price on request *** Preis auf Anfrage |
|---|---|--|

POS.	PROD.	ART.	MIS.	Q.TÀ	EURO	EURO
H.180		B-3502 • For glass 8+8 with profile: B-3500-N	3000 mm	1 pc	12,33/m	37,00/pc
H.181		B-3503 • For glass 6+6 / 12 / 10 / 8 with profile: B-3500-N	3000 mm	1 pc	15,43/m	46,30/pc
H.182		B-3602 • For profile: B-3600	800 mm	3 pcs		48,30 /set
H.183						
H.184						
H.184.1		UB-7004 • For glass 8+8 with profile: UB-120	120 mm	1 pc		23,70/pc
		IUB-7004	120 mm	■ min 40 pcs		9,30/pc
H.184.2		UB-7002 • For glass 10+10 with profile: UB-120	120 mm	1 pc		23,70/pc
		IUB-7002	120 mm	■ min 40 pcs		9,30/pc
H.184.3		UB-7006 • For glass 8+8 with profile: UB-220	220 mm	1 pc		24,70/pc
		IUB-7006	220 mm	■ min 40 pcs		9,70/pc
H.184.4		UB-7005 • For glass 10+10 with profile: UB-220	220 mm	1 pc		24,70/pc
		IUB-7005	220 mm	■ min 40 pcs		9,70/pc
H.184.5		UB-121 • For profile: UB-120	120 mm	2 pcs		23,70/set
		IUB-121	120 mm	■ min 40 pcs		6,50/pc
H.184.6		UB-221 • For profile: UB-220	220 mm	2 pcs		24,70/set
		IUB-221	220 mm	■ min 40 pcs		6,70/pc

POS.	PROD.	ART.	MIS.	Q.TÀ	EURO	EURO
------	-------	------	------	------	------	------

GUARNIZIONI PER VELETTE / GASKETS FOR COVER PROFILES / DICHTUNGEN FÜR ABDECKUNGEN

H.185		B-8011-8 • For glass 8+8 with cover profiles: B-8001 / B-8051 / B-8251 / B-8201 / B-8121 B-8721 / B-3501 / B-3551	3000 mm	1 pc	8,83/m	26,50 /pc
H.186		B-8011-10 • For glass 10+10 with cover profiles: B-8001 / B-8051 / B-8251 / B-8121 B-3501 / B-3551	3000 mm	1 pc	8,83/m	26,50 /pc
H.187		B-8011-12 • For glass 12+12 with cover profiles: B-8001 / B-8051 / B-8251 / B-8121	3000 mm	1 pc	9,33/m	28,00 /pc
H.188		B-4101-8 • For glass 8+8 with cover profiles: B-6001 / B-6051 / B-6201 / B-6121 / B-2001 B-2051	3000 mm	1 pc	7,23/m	21,70 /pc
H.189		B-4101-10 • For glass 10+10 with cover profiles: B-6001 / B-6051 / B-6201 / B-6121 / B-2001 B-2051	3000 mm	1 pc	7,23/m	21,70/pc
H.190		B-4101-12 • For glass 12+12 with cover profiles: B-6001 / B-6051 / B-6201 / B-6121 / B-2001 B-2051	3000 mm	1 pc	7,23/m	21,70/pc
H.191		B-6611-8	3000 mm	1 pc	11,00/m	33,00/pc
H.192		B-6611-10	3000 mm	1 pc	11,00/m	33,00 /pc
H.193						
H.193.1		B-8711-8 • For profile B-8700 with glass 8+8 with cover profiles: B-8001 / B-8051 / B-8251 / B-8201 / B-8121 B-8721	3000 mm	1 pc	11,67/m	35,00/pc
H.193.2		B-8711-10 • For profile B-8700 with glass 10+10 with cover profiles: B-8001 / B-8051 / B-8251 / B-8201 / B-8121 B-8721	3000 mm	1 pc	11,67/m	35,00 /pc

- Confezioni industriali
- Industrial packaging
- Industrieverpackungen
- * Senza velette
- * Without cover profiles
- * Ohne Abdeckungen
- *** Prezzo su richiesta
- *** Price on request
- *** Preis auf Anfrage

POS.	PROD.	ART.	Q.TÀ	EURO
------	-------	------	------	------

ACCESSORI / ACCESSORIES / ZUBEHÖRE

H.194		CLIPS <ul style="list-style-type: none"> For cover profiles: B-6001 / B-6051 / B-6601 / B-6651 / B-2001 / B-2051 B-6201 / B-6121 	18 pcs	24,50/set
H.195		CLIP-CMR <ul style="list-style-type: none"> For cover profiles: B-8001 / B-8051 / B-8251 / B-8121 / B-3501 / B-3551 B-8061 	18 pcs	28,00/set
H.196		B-6009 <ul style="list-style-type: none"> For glass 8+8 with Jollypack: B-3208 / B-8008 / B-3008J / B-6608 / B-6008 B-3508 / B-4508 	6 pcs	46,70/set
H.197		P-F26 <ul style="list-style-type: none"> Set 4 pz spine di congiunzione profili Set 4 pins connecting profiles Set 4 Stk Verbindungsstifte 	4 pcs	10,70/set
H.198		P-F27 <ul style="list-style-type: none"> Kit anti-infiltrazione acqua per fissaggio con barra filettata Kit Anti-infiltration for installation with threaded bars Kit gegen infiltration für Montage mit Gewindestangen 	15 pcs	66,30/set
H.199		B-4111-CF8 <ul style="list-style-type: none"> "Ombrellino" a molla anti infiltrazione vetro/vetro. Prezzo per confezione di 8 pezzi Adjustable gasket "Umbrella" anti-filtration glass/glass. Price each package unit of 8 pieces Verstellbare Dichtung Glas/Glas "Regenschirm" gegen Infiltration. Preis pro Verpackungseinheit von 8 Stück 	8 pcs	89,70/set
H.200		B-2009-10 <ul style="list-style-type: none"> 4 pcs 35,00/set 	4 pcs	35,00/set
		B-2009-20 <ul style="list-style-type: none"> 4 pcs 44,00/set 	4 pcs	44,00/set
		B-2009-MIS <ul style="list-style-type: none"> Guarnizione anti infiltrazione vetro/vetro. Gasket anti-filtration glass/glass. Dichtung Glas/Glas gegen Infiltration. 		47,30/m
H.201		B-3509 <ul style="list-style-type: none"> Inserto esagonale 3 mm per chiave a "T", fissaggio morsetti Jollypack. Hexagonal bit 3 mm for T-handle wrench, fixing Jollypack clamps. Sechskant-Schraubeinsatz 3 mm für "T" Stiftschlüssel, Jollypack Klemmen Befestigung. 	1 pc	25,30/set
H.202		B-1055 <ul style="list-style-type: none"> Vite con esagono per bilanciamento profilo nel cemento B-4050 / B-2060 Set profile screw with Hexagon for balancing Profiles B-4050 / B-2060 Set Schraube mit Sechskant für Profil Einstellung B-4050 / B-2060 	6 pcs	82,30/set

POS.	PROD.	ART.	Q.TÀ	EURO
H.203		B-8000-DIMA <ul style="list-style-type: none"> Dima per montaggio facile e veloce balaustre "CMR" (vedi video) Template for easy and quick installation railing system "CMR" (see video) Schablone für einfache und schnelle Montage Geländerprofile "CMR" (sehen Video) 		40,70/pc
H.204		B-8000-POS <ul style="list-style-type: none"> Posizionatore vetri per montaggio balaustre "CMR" (vedi video) Glass positioner for installation railing systems "CMR" (see video) Glasstellungsregler für Montage Geländerprofile "CMR" (sehen Video) 		48,30/pc
H.205		B-3015 <ul style="list-style-type: none"> Profili di scolo montaggio a pavimento per balaustre B-3000. Drainage profiles floor installation for railing profile B-3000. Drainageleisten Bodenmontage für Geländerprofil B-3000 	15 pcs	106,30/set
H.206		B-6103 <ul style="list-style-type: none"> Profili di scolo montaggio a pavimento e laterale per balaustre B-6000. Drainage profiles floor and side installation for railing profile B-6000. Drainageleisten Boden und Seitenmontage für Geländerprofil B-6000. 	5 pcs	211,00/set
H.207		BWC-CMR <ul style="list-style-type: none"> Tappi anti-infiltrazione acqua per CMR Kit watercap for CMR 	15 pcs	70,00/set 4,67 /pc
		IBWC-CMR	■ min 150 sets	4,00/pc

■ * ***

- Confezioni industriali
- Industrial packaging
- Industrieverpackungen
- Senza vellete
- Without cover profiles
- Ohne Abdeckungen
- Prezzo su richiesta
- Price on request
- Preis auf Anfrage

POS.	PROD.	ART.	Q.TÀ	EURO	
		BWC-10 • Tappi anti-infiltrazione acqua èer UNIBLOCK • Kit watercap for UNIBLOCK	15 pcs	70,00 /set 4,67 /pc	
		IBWC-10	■ min 150 sets	4,00/pc	
H.208		BSA-10 • Profilo scolo acqua • Drainage profile • Drainage Profil	L = 3000 mm	163,00 /pc 54,34 /m	
			3 mt	6 mt	
		IBSA-10	■ min 30 mt	131,00 /pc	277,70/pc
		IBSA-10	■ min 72 mt	119,70 /pc	256,30/pc
		BSA-10-8700 • Profilo scolo acqua per profilo B-8700 • Drainage profile for B-8700 • Drainage Profil für B-8700	L = 3000 mm	/pc /m	
			3 mt	6 mt	
		IBSA-10-8700	■ min 30 mt	/pc	/pc
		IBSA-10-8700	■ min 72 mt	/pc	/pc
H.209		BSA-11 • Guarnizione anti-infiltrazione per profilo BSA-10 • Seal anti-infiltration for profile BSA-10 • Dichtung gegen infiltration für Profil BSA-10	15 pcs	41,30 /set 2,75 /pc	
		BSA-11	■ min 150 pcs	1,70/pc	
H.209.1		B-3115 • Per vetro 6 - 12 mm • For glass 6 - 12 mm • Für Glas 6 - 12 mm	1 pc	45,00/pc	
		IB-3115	■ min 20 pcs	26,30/pc	
H.209.2		B-3116 • Per vetro 17,5 - 21,5 mm • For glass 17,5 - 21,5 mm • Für Glas 17,5 - 21,5 mm	1 pc	45,00/pc	
		IB-3116	■ min 20 pcs	26,30/pc	

POS.	PROD.	ART.	MIS.	Q.TÀ	FIN.	EURO	FIN.	EURO	FIN.	EURO
------	-------	------	------	------	------	------	------	------	------	------

CANALINA PER LED LED U-CANNEL / LED U-PROFIL

		B-3112 ▶ BALAUSTR E PENSILINE 127								
H.210		B-3112	3000 mm	1 pc	AN	193,00/set				
		IB-3112	6000 mm	■ min 8 pcs	AN	282,30/pc 47,05/m				
		IB-3112	3000 mm	■ min 16 pcs	AN	151,70/pc 50,57/m				
H.211		B-3112-T		1 pc	AN	19,50/pc				
				■ min 10 pcs	AN	11,30/pc				

CORRIMANO HANDRAIL PROFILE / HANDLAUF PROFIL



		B-3040 ▶ BALAUSTR E PENSILINE 102								
H.212		B-3040	5000 mm	1 pc	AN	350,30/pc 70,06/m	IXE	436,50/pc 87,30/m		
		IB-3040	5000 mm	■ min 4 pcs	AN	287,00/pc 57,40/m	IX	358,00/pc 71,60/m		
COMPONENTI / COMPONENTS / EINZELTEILE										
H.213		B-3044		1 pc		31,30/pc				
H.214		B-3047		1 pc	AN	15,50/pc	IXE	19,30/pc		
H.215		B-3043		1 pc		31,30/pc				
H.216		B-3048		1 pc		*** /pc				

- | | | |
|--------------------------|-------------------|-----------------------|
| ■ | *** | *** |
| • Confezioni industriali | • Senza parete | • Prezzo su richiesta |
| • Industrial packaging | • Without cover | • Price on request |
| • Industrieverpackungen | • Ohne Aufdeckung | • Preis auf Anfrage |

POS.	PROD.	ART.	MIS.	Q.TÀ	FIN.	EURO	FIN.	EURO	FIN.	EURO
------	-------	------	------	------	------	------	------	------	------	------

CORRIMANO

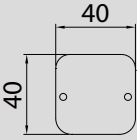
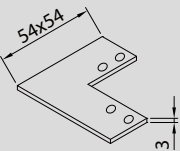
HANDRAIL PROFILE / HANDLAUF PROFIL

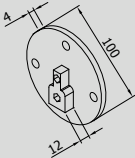
		B-3030		▶ BALAUSTR E PENSILINE 103						
H.217		B-3030	5000 mm	1 pc	AN	425,70 /pc 85,14 /m				
		IB-3030	5000 mm	■ min 4 pcs	AN	337,50 /pc 67,50 /m				
COMPONENTI / COMPONENTS / EINZELTEILE										
H.218		B-3037		1 pc	AN	17,00 /pc				
H.219		B-3033		1 pc		31,30 /pc				
H.220		B-3013 • Optional for LED	3000 mm	1 pc		44,30 /pc 14,77 /m				
H.221		B-3012 • Optional for LED	3000 mm	1 pc		39,70 /pc 13,23 /m				
H.222		B-3038		1 pc		*** /pc				





POS.	PROD.	ART.	MIS.	Q.TÀ	FIN.	EURO	FIN.	EURO	FIN.	EURO
------	-------	------	------	------	------	------	------	------	------	------

PROFILI PROTEZIONE BORDO VETRO

EDGE PROTECTION PROFILE / KANTENSCHUTZPROFILE

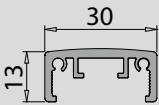
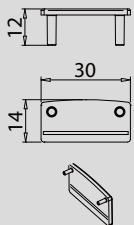
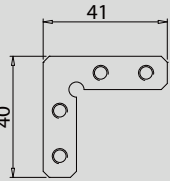
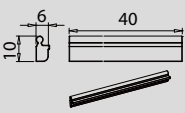
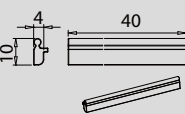
		B-3050	▶ BALAUSTR E PENSILINE 100								
H.223		B-3050 • For glass 8+8 10+10	3000 mm	1 pc	AN	37,50/pc 12,50/m	GR	28,30/pc 9,43/m			
		B-3050-12 • For glass 12+12	3000 mm	1 pc	AN	44,00/pc 14,67/m	GR	34,00/pc 11,33/m			
		B-3050-6 • For glass 6+6	3000 mm	1 pc	AN	35,30/pc 11,77/m	GR	28,00/pc 9,33/m			
COMPONENTI / COMPONENTS / EINZELTEILE											
H.224		IB-3050 • For glass 8+8 10+10	6000 mm	■ min 10 pcs	AN	62,30/pc 10,38/m	GR	48,30/pc 8,05/m			
H.225		IB-3050-12 • For glass 12+12	6000 mm	■ min 10 pcs	AN	70,30/pc 11,72/m	GR	55,70/pc 9,28/m			
H.225.1		IB-3050-6 • For glass 6+6	6000 mm	■ min 10 pcs	AN	58,00/pc 9,67/m	GR	43,50/pc 7,25/m			
H.226		B-3051 • For B-3050		2 pcs	AN	10,70/set					
H.227		B-3053 • For 90° corner • For glass 8+8 10+10		1 pc		15,30/pc					
H.228		B-3052-8 • For glass 8+8		8 pcs		34,30/set 4,29/pc					
H.229		B-3052-10 • For glass 12+12 10+10 6+6		8 pcs		34,30/set 4,29/pc					

- Confezioni industriali
- Senza vellete
- ***
- Industrial packaging
- Without cover profiles
- Prezzo su richiesta
- Industrieverpackungen
- Ohne Abdeckungen
- Price on request
- Preis auf Anfrage

POS.	PROD.	ART.	MIS.	Q.TÀ	FIN.	EURO	FIN.	EURO	FIN.	EURO
B-3055 ▶ BALAUSTR E PENSILINE 100										
H.230		B-3055 • For glass 8+8 10+10	3000 mm	1 pc	AN	49,30/pc 16,43/m				
COMPONENTI / COMPONENTS / EINZELTEILE										
H.231		IB-3055 • For glass 8+8 10+10	6000 mm	■ min 10 pcs	AN	83,00/pc 13,83/m				
H.232		B-3056		2 pcs	AN	10,70/set				
H.233		B-3058 • For 90° corner		1 pc		51,30/pc				
H.234		B-3057-8 • For glass 8+8		8 pcs		34,30/set 4,29/pc				
H.235		B-3057-10 • For glass 10+10		8 pcs	AN	34,30/set 4,29/pc				
V-2034 / V-2035 ▶ BALAUSTR E PENSILINE 101										
H.236		V-2034-MIX	3000 mm	min 5 pcs	IX	90,00/pc	IL	92,00/pc		
		V-2034-CF12 	3000 mm	■ 12 pcs	IX	79,83/pc 958,00/☞	IL	78,13/pc 937,50/☞		
H.237		V-2035-MIX	3000 mm	min 5 pcs	IX	93,00/pc	IL	95,50/pc		
		V-2035-CF12 	3000 mm	■ 12 pcs	IX	83,17/pc 998,00/☞	IL	84,94/pc 1019,30/☞		

POS.	PROD.	ART.	MIS.	Q.TÀ	FIN.	EURO	FIN.	EURO	FIN.	EURO
CORRIMANO / HANDRAILPROFILE / HANDLAUF PROFIL						▶ BALAUSTR E PENSILINE 104				
H.238		B-1010-MIX	3000 mm	min 5 pcs	IX	172,30/pc 57,43 /m				
H.239		B-1015-17,5	6000 mm	1 pc	IX	69,30/pc 11,55 /m				
H.240		B-1015-21,5	6000 mm	1 pc	IX	55,30/pc 9,22 /m				
H.241		B-1017		1 pc	IX	29,00/pc				
H.242		B-1012		1 pc	IX	43,00/pc				
H.243		B-1018		1 pc	IX	20,00/pc				
H.244		B-1014		1 pc	IX	26,50/pc				
H.245		B-1011		1 pc	IX	37,30/pc				
H.246		B-1016		1 pc	IX	55,30/pc				
H.247		B-1016-VR-A		1 pc	IX	59,00/pc				
H.248		B-1016-VR-B		1 pc	IX	59,00/pc				

-
- *
 - Confezioni industriali
 - Industrial packaging
 - Industrieverpackungen
- *
 - Senza velette
 - Without cover profiles
 - Ohne Abdeckungen
- ***
 - Prezzo su richiesta
 - Price on request
 - Preis auf Anfrage

POS.	PROD.	ART.	MIS.	Q.TÀ	FIN.	EURO	FIN.	EURO	FIN.	EURO
H.249		V-093	4000 mm	1 pc	IX	232,70/pc 58,18/m				
H.250		V-094		1 pc	IX	11,30/pc				
H.251		V-095		1 pc	IX	15,30/pc				
H.252		V-096		1 pc	IX	28,70/pc				
H.253		V-097		1 pc	IX	25,50/pc				
H.254		V-098		1 pc	IX	136,30/pc				
H.255		V-065-1		1 pc	IX	40,70/pc				
H.256		V-065-2		1 pc	IX	31,30/pc				
H.257		V-065-3		1 pc	IX	33,50/pc				
H.258		V-066-1		1 pc	IX	52,00/pc				
H.259		V-066-2		1 pc	IX	61,00/pc				

POS.	PROD.	ART.	MIS.	Q.TÀ	FIN.	EURO	FIN.	EURO	FIN.	EURO
------	-------	------	------	------	------	------	------	------	------	------

TASSELLI / ANCHORS / ANKER

► BALAUSTR E PENSILINE 125

H.260		P-F35		15 pcs		60,00/set 4,00 /pc				
H.261		FBS 12X110+15		15 pcs		188,70/set 12,58 /pc				
H.262		TA M8 T/25 S		15 pcs		83,00/set 5,53 /pc				
H.263		TA M8/30 SK		15 pcs		122,50/set 8,17 /pc				

-
- Confezioni industriali
- Industrial packaging
- Industrieverpackungen
- *
 - Senza vellete
 - Without cover profiles
 - Ohne Abdeckungen
- ***
 - Prezzo su richiesta
 - Price on request
 - Preis auf Anfrage



POS.	PROD.	ART.	MIS.	Q.TÀ	FIN.	EURO	FIN.	EURO	FIN.	EURO
------	-------	------	------	------	------	------	------	------	------	------

PARAVENTO / WINDSCREEN / WINDSCHUTZSYSTEME

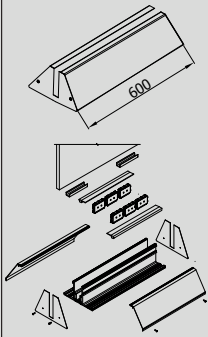
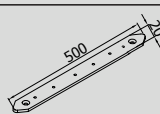
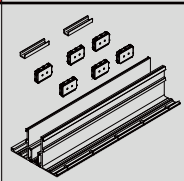
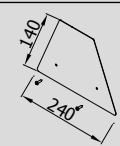
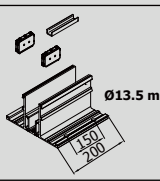
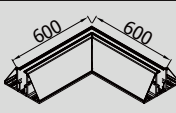
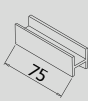
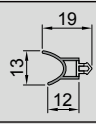
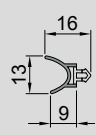
B-2800		► BALAUSTR E PENSILINE 92									
H.264		B-2800	600 mm	1 set	AN	556,30/set					
H.265		B-2809		2 pcs	AN	138,00/set					
B-2860 / B-2820		► BALAUSTR E PENSILINE 94									
H.266		B-2860	600 mm	1 set	AN	413,30/set					
H.267		B-2801-CF2	3000 mm	2 pcs	AN	393,00/set					
		B-2801	3000 mm	min 6 pcs	AN	155,30/pc					
H.268		B-2806		1 pc	AN	49,50/pc					
H.269		B-2820	200 mm	1 set	AN	263,70/set					
H.270		B-2870		1 set	AN	1994,00/set					
H.271		B-2007-8 B-2007-10		9 pcs	AN	40,70/set					
H.272		B-4101-8	3000 mm	1 pc	AN	21,70/pc					
H.273		B-4101-10	3000 mm	1 pc	AN	21,70/pc					

- Confezioni industriali
- Industrial packaging
- Industrieverpackungen
- * Senza velette
- * Without cover profiles
- * Ohne Abdeckungen
- *** Prezzo su richiesta
- *** Price on request
- *** Preis auf Anfrage

POS.	PROD.	ART.	MIS.	Q.TÀ	FIN.	EURO	FIN.	EURO	FIN.	EURO
B-3004 / B-3006 / B-3008 / B-3002										
H.274		B-3004-PAR	2900 mm	3 pcs	AN	243,50/set 27,99 /m				
H.275		B-3008	2900 mm	3 pcs	AN	326,00/set 37,47 /m				
H.276		B-3006	2900 mm	3 pcs	AN	311,00/set 35,75 /m				
H.277		B-3009-V		1 pc	AN	54,30				
H.278		B-3009-0		1 pc	AN	49,50				

POS.	PROD.	ART.	Q.TÀ	FIN.	EURO
------	-------	------	------	------	------

PENSILINE
GLASS CANOPY / VORDACH SYSTEM

ATTENZIONE: per garantire una perfetta tenuta del profilo, il taglio effettuato da parte del cliente deve essere esente da bave e rigature
ATTENTION: in order to ensure the seal, the cut by the customer must be without protrusions
ACHTUNG: um die Dichtheit zu gewährleisten, bauseitiger Schnitt muss gratfrei sein

B-5040 KAMPIONA DRAIN		► BALAUSTR E PENSILINE 130					
H.279	<p>Quota variabile / Variable size / Variables Maß</p>	B-5040 SET 1	AN	1500 mm	1 set	1248,70/set	
		B-5040 SET 2	AN	2000 mm	1 set	1580,00/set	
		B-5040 SET 3	AN	3000 mm	1 set	2162,50/set	
		B-5040 SET 4	AN	4000 mm	1 set	2926,00/set	
		B-5040 SET 6	AN	6000 mm	1 set	4091,00/set	
			AN	1000 → 2000 mm	1 set	1668,30/set	
		B-5040-MIS	AN	2000 → 3000 mm	1 set	2254,00/set	
			AN	3000 → 4000 mm	1 set	3000,50/set	
		COST EXAMPLE ONLY		6 mt		3 mt	
		IB-5040 SET 1	AN	1500 mm	min 48 mt	 SID /set^	min 24 mt SIE /set°
IB-5040 SET 2	AN	2000 mm	min 48 mt	 SIF /set^			
IB-5040 SET 3	AN	3000 mm	min 48 mt	 SIG /set^	min 24 mt SIH /set°		
IB-5040 SET 4	AN	4000 mm	min 48 mt	 SII /set^			
IB-5040 SET 6	AN	6000 mm	min 48 mt	 SIJ /set^			
<ul style="list-style-type: none"> NB: Predisporre foratura su substruttura solo a ricevimento dei profili per verifica interasse fori e distanza di foratura Note well: drill possible substructure only after receiving the profile to verify axe fixing holes <p>^ Set ricavati con taglio profili da 6 mt a cura del cliente / Cut by installer with 6 mt bar / Schnitt bauseitig mit 6 mt Stange ° Set ricavati con taglio profili da 3 mt a cura del cliente / Cut by installer with 3 mt bar / Schnitt bauseitig mit 3 mt Stange</p>							

COMPONENTI / COMPONENTS / EINZELTEILE	
H.280	<p>B-5040-SL</p> <p>1 set AN 210,00 /set</p> <p> min 8 sets AN 147,30 /set</p>
	<p>B-5040-SI</p> <p>1 set AN 218,50 /set</p> <p> min 8 sets AN 147,30 /set</p>
H.281	<p>LAV-B-5040-SI-SX</p> <ul style="list-style-type: none"> Foratura profilo Profile preparation Profilbearbeitung <p>Sinistro Left Links</p>
	<p>LAV-B-5040-SI-DX</p> <ul style="list-style-type: none"> Foratura profilo Profile preparation Profilbearbeitung <p>Destro Right Rechts</p>
<p>1 pc 240,00 /pc</p>	

■ Confezioni industriali / Industrial packaging / Industrieverpackungen
***** Esempio di costo con imballaggio industriale / Example of cost with industrial packaging / Beispiel des Abrechnungspreises mit Industrieverpackung
******* Prezzo di riferimento / Reference price / Referenzpreis

COMPONENTI / COMPONENTS / EINZELTEILE							
H.282			B-5040-SP 	1 set	AN	189,30 /set	
			■ min 8 sets	AN	144,70 /set		
			B-5040-2-SP 	1 set	AN	225,30 /set	
			■ min 8 sets	AN	173,00 /set		
	Sinistro Left Links 	LAV-B-5040-SP-SX <ul style="list-style-type: none"> • Foratura profilo • Profile preparation • Profilbearbeitung 	1 pc	AN	240,00 /pc		
	Destro Right Rechts 	LAV-B-5040-SP-DX <ul style="list-style-type: none"> • Foratura profilo • Profile preparation • Profilbearbeitung 					
	Sinistro Left Links 	LAV-B-5040-2-SP-SX <ul style="list-style-type: none"> • Doppia foratura profilo • Double profile preparation • Doppelte Profilbearbeitung 	1 pc			283,50 /pc	
	Destro Right Rechts 	LAV-B-5040-2-SP-DX <ul style="list-style-type: none"> • Doppia foratura profilo • Double profile preparation • Doppelte Profilbearbeitung 					
H.283			B-5049-TCH <ul style="list-style-type: none"> • 2 tappi chiusi + 2 guarnizioni + 2 spine • 2 caps + 2 gaskets + 2 pins • 2 Kappen + 2 Dichtungen + 2 Stifte 	1 set	AN		195,30 /set
			■ min 8 sets	AN	162,50 /set		
H.284			B-5049-TAG <ul style="list-style-type: none"> • 2 tappi + 2 guarnizioni + 2 spine • 2 caps + 2 gaskets + 2 pins • 2 Kappen + 2 Dichtungen + 2 Stifte 	1 set	AN	196,30 /set	
			■ min 8 sets	AN	169,30 /set		
H.285			B-5049-INS-INT <ul style="list-style-type: none"> • Giunti intermedi per tiranti set 3 pc + 1 guarnizione tenuta stagna • Intermediate joints for tie rods set 3 pc + 1 watertight seal • Zwischengelenke für Zugstangen set 3 stück + 1 wasserdichte Dichtung 	3 pcs	AN	62,70 /set	
			■ min 8 sets	AN	50,70 /set		
H.285.1			B-5048-SI <ul style="list-style-type: none"> • Scarico inferiore • Lower drain • Unterer Abfluss 	1 pc	AN	100,30 /set	
			■ min 8 pcs	AN	80,30 /set		

COMPONENTI / COMPONENTS / EINZELTEILE				
H.285.2		B-5046 • Tappo + guarnizione • Endcap + gasket • Endkappe + Dichtung	1 set	AN 70,30 /set
			■ min 8 sets	AN 59,30 /set
H. 285.3		B-5049-TIR • Barre tiranti M6x3000 mm set 3 pc. Tiranti per chiusura a pacco tenuta stagna. • M6x3000 mm tie rods set 3 pc. Tie rods for watertight bundle closure. • Zugstangen M6x3000 set 3 Stück. Zugstangen für wasserdichten Packverschluss.	1 set	AN 82,00 /set
			■ min 8 sets	AN 53,70 /set
H.285.4		B-5049-GIUNTI • Giunti per aste filettate • Joints for threaded rods • Verbindungen für Gewindestangen	3 pcs	AN 41,00 /set
			■ min 8 sets	AN 26,30 /set
H.285.5		B-5049-INS-FIN • Inserti finali M6, set 6 pc • End insert M6, set 6 pc • Endeinsätze M6, set 6 pc	6 pcs	AN 68,30 /set
			■ min 8 sets	AN 51,00 /set

POS.	PROD.	ART.	FIN.	MIS.	Q.TÀ	EURO	EURO
------	-------	------	------	------	------	------	------

B-1040 KAMPIONA 110 ▶ BALAUSTR E PENSILINE 150

H.286		B-1040 SET 1	AN	1500 mm	1 set	550,50 /set					
		B-1040 SET 2	AN	2000 mm	1 set	700,70 /set					
		B-1040 SET 3	AN	3000 mm	1 set	965,30 /set					
		B-1040 SET 4	AN	4000 mm	1 set	1400,00 /set					
		B-1040 SET 6	AN	6000 mm	1 set	2028,30 /set					
			AN	1000 → 2000 mm	1 set	797,50 /set					
		B-1040-MIS	AN	2000 → 3000 mm	1 set	1082,00 /set					
			AN	3000 → 4000 mm	1 set	1435,30 /set					
		COST EXAMPLE ONLY						6 mt		3 mt	
		IB-1040 SET 1	AN	1500 mm	min 48 mt	 SJT /set[^]	min 24 mt	 SJU /set^o			
IB-1040 SET 2	AN	2000 mm	min 48 mt	 SJV /set[^]							
IB-1040 SET 3	AN	3000 mm	min 48 mt	740,00/set[^]	min 24 mt	 SJX /set^o					
IB-1040 SET 4	AN	4000 mm	min 48 mt	 SJV /set[^]							
IB-1040 SET 6	AN	6000 mm	min 48 mt	1442,00/set[^]							

- NB: Predisporre foratura su substruttura solo a ricevimento dei profili per verifica interasse fori e distanza di foratura
- Note well: drill possible substructure only after receiving the profile to verify axe fixing holes



[^] Set ricavati con taglio profili da 6 mt a cura del cliente / Cut by installer with 6 mt bar / Schnitt bauseitig mit 6 mt Stange
^o Set ricavati con taglio profili da 3 mt a cura del cliente / Cut by installer with 3 mt bar / Schnitt bauseitig mit 3 mt Stange

B-6040 KAMPIONA 150 ▶ BALAUSTR E PENSILINE 152

H.287		B-6040 SET 1	AN	1500 mm	1 set	711,30 /set					
		B-6040 SET 2	AN	2000 mm	1 set	910,00 /set					
		B-6040 SET 3	AN	3000 mm	1 set	1348,70 /set					
		B-6040 SET 4	AN	4000 mm	1 set	1735,00 /set					
		B-6040 SET 6	AN	6000 mm	1 set	2476,50 /set					
			AN	1000 → 2000 mm	1 set	1016,30 /set					
		B-6040-MIS	AN	2000 → 3000 mm	1 set	1391,30 /set					
			AN	3000 → 4000 mm	1 set	1765,70 /set					
		COST EXAMPLE ONLY						6 mt		3 mt	
		IB-6040 SET 1	AN	1500 mm	min 48 mt	 SKI /set[^]	min 24 mt	 SKJ /set^o			
IB-6040 SET 2	AN	2000 mm	min 48 mt	 SKK /set[^]							
IB-6040 SET 3	AN	3000 mm	min 48 mt	 SKL /set[^]	min 24 mt	 SKM /set^o					
IB-6040 SET 4	AN	4000 mm	min 48 mt	 SKN /set[^]							
IB-6040 SET 6	AN	6000 mm	min 48 mt	1809,50/set[^]							

- NB: Predisporre foratura su substruttura solo a ricevimento dei profili per verifica interasse fori e distanza di foratura
- Note well: drill possible substructure only after receiving the profile to verify axe fixing holes

[^] Set ricavati con taglio profili da 6 mt a cura del cliente / Cut by installer with 6 mt bar / Schnitt bauseitig mit 6 mt Stange
^o Set ricavati con taglio profili da 3 mt a cura del cliente / Cut by installer with 3 mt bar / Schnitt bauseitig mit 3 mt Stange

POS.	PROD.	ART.	FIN.	MIS.	Q.TÀ	EURO	EURO
COMPONENTI / COMPONENTS / EINZELTEILE							
H.288		B-1040	AN	1500 mm	1 pc	365,70 /pc	
				2000 mm	1 pc	480,00 /pc	
				3000 mm	1 pc	672,50 /pc	
				4000 mm	1 pc	910,00 /pc	
				 6000 mm	1 pc	1334,70 /pc	
				3000 mm	■ min 24 m	603,70 /pc	
				 6000 mm	■ min 48 m	1069,30 /pc	
H.289		B-6040	AN	1500 mm	1 pc	520,00 /pc	
				2000 mm	1 pc	678,50 /pc	
				3000 mm	1 pc	946,70 /pc	
				4000 mm	1 pc	1280,50 /pc	
				 6000 mm	1 pc	1872,00 /pc	
				3000 mm	■ min 24 m	792,00 /pc	
				 6000 mm	■ min 48 m	1433,30 /pc	
H.290		B-1041		3000 mm	1 pc	14,30 /pc	
				3000 mm	■ min 24 m	11,00 /m	
H.291		B-6041		3000 mm	1 pc	52,50 /pc	
				3000 mm	■ min 24 m	9,00 /m	
H.292		B-1048			1 pc	41,00 /pc	
					■ min 48 pcs	13,50 /pc	
H.293		B-1044-F			10 pc	41,00 /set	
					■ min 120 pc	3,00 /pc	
H.294		B-6045-F			10 pcs	41,00 /set	
					■ min 120 pcs	3,00 /pc	
H.295		B-1046			2 pcs	41,00 /set	
					■ min 8 sets	33,50 /set	
H.296		B-6046			2 pcs	43,30 /set	
					■ min 8 sets	36,00 /set	
H.297		P-F26			4 pcs	10,70 /set	



- Confezioni industriali • Senza vellete • Prezzo su richiesta
- Industrial packaging • Without cover profiles • Price on request
- Industrieverpackungen • Ohne Abdeckungen • Preis auf Anfrage

POS.	PROD.	ART.	MIS.	Q.TÀ	FIN.	EURO	FIN.	EURO	FIN.	EURO
------	-------	------	------	------	------	------	------	------	------	------

CANALINA PER LED



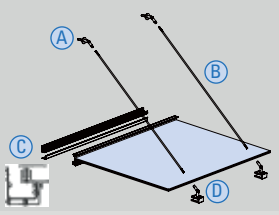

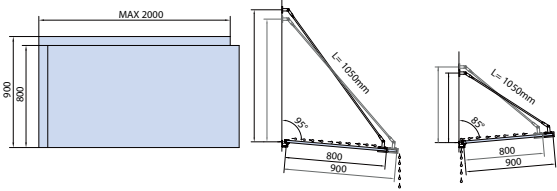
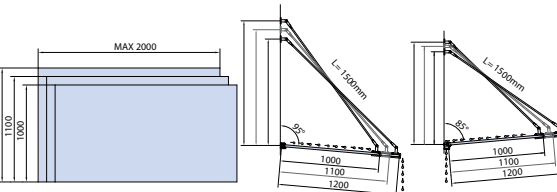
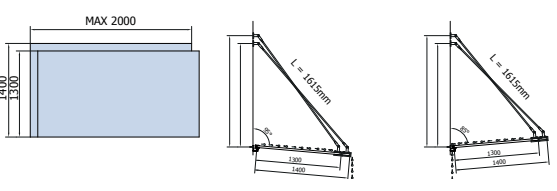
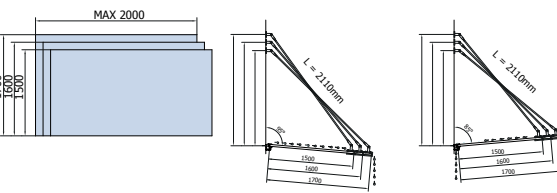

LED U-CHANNEL / LED U-PROFIL

B-1042		▶ BALAUSTR E PENSILINE 154								
H.298		B-1042	3000 mm	1 set	AN	154,30/set				
H.299		B-1043		2 pcs	AN	14,30/set				
H.300		B-1047 • For profile B-1040		2 pcs	AN	38,00/set				
H.301		B-6047 • For profile B-6040		2 pcs	AN	41,00/set				
H.302		P-F31		2 pcs		9,00/set				

POS.	PROD.	ART.	FIN.	Q.TÀ	EURO
	 				► BALAUSTR E PENSILINE 160
H.313		<p>PRESA SET 1</p> <ul style="list-style-type: none"> • Set: <ul style="list-style-type: none"> n° 2 S-FIX-SUP (A) n° 2 S-BAR-1050 (B) n° 1 PRESA-PROFILO L=2000 mm (C) n° 2 PRESA-MORSA (D) 	AN	1 set	1070,00 /set
H.314		<p>PRESA SET 2</p> <ul style="list-style-type: none"> • Set: <ul style="list-style-type: none"> n° 2 S-FIX-SUP (A) n° 2 S-BAR-1500 (B) n° 1 PRESA-PROFILO L=2000 mm (C) n° 2 PRESA-MORSA (D) 	AN	1 set	1109,30 /set
H.315		<p>PRESA SET 3</p> <ul style="list-style-type: none"> • Set: <ul style="list-style-type: none"> n° 2 S-FIX-SUP (A) n° 2 S-BAR-1625 (B) n° 1 PRESA-PROFILO L=2000 mm (C) n° 2 PRESA-MORSA (D) 	AN	1 set	1122,70 /set
H.316		<p>PRESA SET 4</p> <ul style="list-style-type: none"> • Set: <ul style="list-style-type: none"> n° 2 S-FIX-SUP (A) n° 2 S-BAR-2110 (B) n° 1 PRESA-PROFILO L=2000 mm (C) n° 2 PRESA-MORSA (D) 	AN	1 set	1161,50 /set

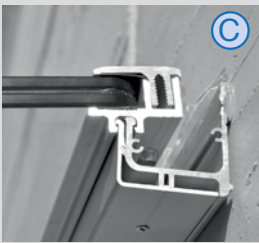

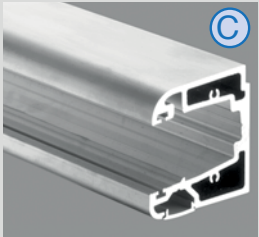

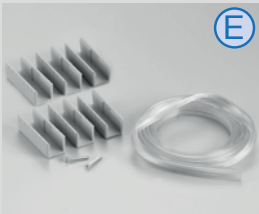
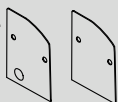
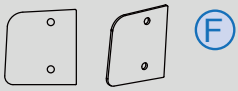



POS.	PROD.	ART.	FIN.	Q.TÀ	EURO	
	<p>PRESA 2</p>				► BALAUSTR E PENSILINE 162	
H.317		<p>PRESA 2 SET 1-8</p> <ul style="list-style-type: none"> Set: n° 2 S-FIX-SUP (A) - n° 2 S-BAR-1050 (B) n° 1 PRESA 2-PROFILO (C) L=2000 mm n°1 PRESA-2-KIT-8 (E) n° 2 PRESA-MORSA (D) n° 1 PRESA-2-TAPPO (F) 	AN	for glass 8+8+1,52	1 set	1013,70/set
		<p>PRESA 2 SET 1-10</p> <ul style="list-style-type: none"> Set: n° 2 S-FIX-SUP (A) - n° 2 S-BAR-1050 (B) n° 1 PRESA 2-PROFILO (C) L=2000 mm n°1 PRESA-2-KIT-10 (E) n° 2 PRESA-MORSA (D) n° 1 PRESA-2-TAPPO (F) 	AN	for glass 10+10+1,52		
H.318		<p>PRESA 2 SET 2-8</p> <ul style="list-style-type: none"> Set: n° 2 S-FIX-SUP (A) - n° 2 S-BAR-1500 (B) n° 1 PRESA 2-PROFILO (C) L=2000 mm n°1 PRESA-2-KIT-8 (E) n° 2 PRESA-MORSA (D) n° 1 PRESA-2-TAPPO (F) 	AN	for glass 8+8+1,52	1 set	1052,70/set
		<p>PRESA 2 SET 2-10</p> <ul style="list-style-type: none"> Set: n° 2 S-FIX-SUP (A) - n° 2 S-BAR-1500 (B) n° 1 PRESA 2-PROFILO (C) L=2000 mm n°1 PRESA-2-KIT-10 (E) n° 2 PRESA-MORSA (D) n° 1 PRESA-2-TAPPO (F) 	AN	for glass 10+10+1,52		
H.319		<p>PRESA 2 SET 3-8</p> <ul style="list-style-type: none"> Set: n° 2 S-FIX-SUP (A) - n° 2 S-BAR-1625 (B) n° 1 PRESA 2-PROFILO (C) L=2000 mm n°1 PRESA-2-KIT-8 (E) n° 2 PRESA-MORSA (D) n° 1 PRESA-2-TAPPO (F) 	AN	for glass 8+8+1,52	1 set	1066,50/set
		<p>PRESA 2 SET 3-10</p> <ul style="list-style-type: none"> Set: n° 2 S-FIX-SUP (A) - n° 2 S-BAR-1625 (B) n° 1 PRESA 2-PROFILO (C) L=2000 mm n°1 PRESA-2-KIT-10 (E) n° 2 PRESA-MORSA (D) n° 1 PRESA-2-TAPPO (F) 	AN	for glass 10+10+1,52		
H.320		<p>PRESA 2 SET 4-8</p> <ul style="list-style-type: none"> Set: n° 2 S-FIX-SUP (A) - n° 2 S-BAR-2110 (B) n° 1 PRESA 2-PROFILO (C) L=2000 mm n°1 PRESA-2-KIT-8 (E) n° 2 PRESA-MORSA (D) n° 1 PRESA-2-TAPPO (F) 	AN	for glass 8+8+1,52	1 set	1105,30/set
		<p>PRESA 2 SET 4-10</p> <ul style="list-style-type: none"> Set: n° 2 S-FIX-SUP (A) - n° 2 S-BAR-2110 (B) n° 1 PRESA 2-PROFILO (C) L=2000 mm n°1 PRESA-2-KIT-10 (E) n° 2 PRESA-MORSA (D) n° 1 PRESA-2-TAPPO (F) 	AN	for glass 10+10+1,52		

■ Confezioni industriali • Senza velette • Prezzo su richiesta
 • Industrial packaging • Without cover profiles • Price on request
 • Industrieverpackungen • Ohne Abdeckungen • Preis auf Anfrage

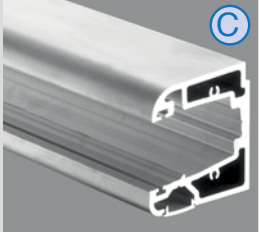
POS.	PROD.	ART.	FIN.	MIS.	Q.TÀ	EURO
COMPONENTI / COMPONENTS / EINZELTEILE						
H.321		S-FIX-SUP	IX AISI 316		1 pc	88,70 /pc
H.322		S-BAR-1050	IX AISI 316	1050 mm	1 pc	69,30 /pc
		S-BAR-1500	IX AISI 316	1500 mm	1 pc	88,70 /pc
		S-BAR-1625	IX AISI 316	1625 mm	1 pc	95,50 /pc
		S-BAR-2110	IX AISI 316	2110 mm	1 pc	115,00 /pc
H.323		PRESA PROFILO	AN	2000 mm	1 pc	527,70 /pc
				3000 mm	1 pc	722,50 /pc
				 6000 mm	1 pc	1301,70 /pc
H.324		PRESA-2-PROFILO	AN	2000 mm	1 pc	308,00 /pc
				3000 mm	1 pc	430,30 /pc
				 6000 mm	1 pc	774,30 /pc
H.325		PRESA-MORSA	AN		1 pc	115,00 /pc
H.326		PRESA-2-KIT-8	for glass 8+8+1,52		1 set	124,30 /set
		PRESA-2-KIT-10	for glass 10+10+1,52			
H.327	OPTIONAL 	PRESA-TAPPO	AN		2 pcs	31,30 /set
H.328		PRESA-2-TAPPO	AN		2 pcs	36,00 /set

POS.	PROD.	ART.	FIN.	Q.TÀ	EURO		
BALAUSTR E PENSILINE 164							
H.329			<p>PRESA 2 SET 5-8</p> <ul style="list-style-type: none"> Set: n° 2 S-FIX-SUP (A) - n° 2 S-BAR-830 (B) n° 1 PRESA 2-PROFILO (C) L=2000 mm n° 1 PRESA 2-KIT-8 (E) - n° 1 PRESA 2-TAPPO (F) n° 2 S-FIX-VETRO-D-44 (D) 	AN	for glass 8+8+1,52	1 set	956,50 /set
			<p>PRESA 2 SET 5-10</p> <ul style="list-style-type: none"> Set: n° 2 S-FIX-SUP (A) - n° 2 S-BAR-830 (B) n° 1 PRESA 2-PROFILO (C) L=2000 mm n° 1 PRESA 2-KIT-10 (E) - n° 1 PRESA 2-TAPPO (F) n° 2 S-FIX-VETRO-D-44 (D) 	AN	for glass 10+10+1,52		
H.330			<p>PRESA 2 SET 6-8</p> <ul style="list-style-type: none"> Set: n° 2 S-FIX-SUP (A) - n° 2 S-BAR-1050 (B) n° 1 PRESA 2-PROFILO (C) L=2000 mm n° 1 PRESA 2-KIT-8 (E) - n° 1 PRESA 2-TAPPO (F) n° 2 S-FIX-VETRO-D-44 (D) 	AN	for glass 8+8+1,52	1 set	974,50 /set
			<p>PRESA 2 SET 6-10</p> <ul style="list-style-type: none"> Set: n° 2 S-FIX-SUP (A) - n° 2 S-BAR-1050 (B) n° 1 PRESA 2-PROFILO (C) L=2000 mm n° 1 PRESA 2-KIT-10 (E) - n° 1 PRESA 2-TAPPO (F) n° 2 S-FIX-VETRO-D-44 (D) 	AN	for glass 10+10+1,52		
H.331			<p>PRESA 2 SET 7-8</p> <ul style="list-style-type: none"> Set: n° 2 S-FIX-SUP (A) - n° 2 S-BAR-1500 (B) n° 1 PRESA 2-PROFILO (C) L=2000 mm n° 1 PRESA 2-KIT-8 (E) - n° 1 PRESA 2-TAPPO (F) n° 2 S-FIX-VETRO-D-44 (D) 	AN	for glass 8+8+1,52	1 set	1013,70 /set
			<p>PRESA 2 SET 7-10</p> <ul style="list-style-type: none"> Set: n° 2 S-FIX-SUP (A) - n° 2 S-BAR-1500 (B) n° 1 PRESA 2-PROFILO (C) L=2000 mm n° 1 PRESA 2-KIT-10 (E) - n° 1 PRESA 2-TAPPO (F) n° 2 S-FIX-VETRO-D-44 (D) 	AN	for glass 10+10+1,52		
H.332			<p>PRESA 2 SET 8-8</p> <ul style="list-style-type: none"> Set: n° 2 S-FIX-SUP (A) - n° 2 S-BAR-1625 (B) n° 1 PRESA 2-PROFILO (C) L=2000 mm n° 1 PRESA 2-KIT-8 (E) - n° 1 PRESA 2-TAPPO (F) n° 2 S-FIX-VETRO-D-60 (D) 	AN	for glass 8+8+1,52	1 set	1043,50 /set
			<p>PRESA 2 SET 8-10</p> <ul style="list-style-type: none"> Set: n° 2 S-FIX-SUP (A) - n° 2 S-BAR-1625 (B) n° 1 PRESA 2-PROFILO (C) L=2000 mm n° 1 PRESA 2-KIT-10 (E) - n° 1 PRESA 2-TAPPO (F) n° 2 S-FIX-VETRO-D-60 (D) 	AN	for glass 10+10+1,52		
H.333			<p>PRESA 2 SET 9-8</p> <ul style="list-style-type: none"> Set: n° 2 S-FIX-SUP (A) - n° 2 S-BAR-2110 (B) n° 1 PRESA 2-PROFILO (C) L=2000 mm n° 1 PRESA 2-KIT-8 (E) - n° 1 PRESA 2-TAPPO (F) n° 2 S-FIX-VETRO-D-60 	AN	for glass 8+8+1,52	1 set	1082,70 /set
			<p>PRESA 2 SET 9-10</p> <ul style="list-style-type: none"> Set: n° 2 S-FIX-SUP (A) - n° 2 S-BAR-2110 (B) n° 1 PRESA 2-PROFILO (C) L=2000 mm n° 1 PRESA 2-KIT-10 (E) - n° 1 PRESA 2-TAPPO (F) n° 2 S-FIX-VETRO-D-60 	AN	for glass 10+10+1,52		



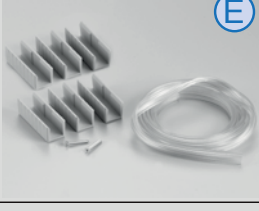
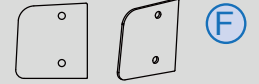

- Confezioni industriali
- Industrial packaging
- Industrieverpackungen
- * Senza velette
- * Without cover profiles
- * Ohne Abdeckungen
- *** Prezzo su richiesta
- *** Price on request
- *** Preis auf Anfrage

POS.	PROD.	ART.	FIN.	MIS.	Q.TÀ	EURO
COMPONENTI / COMPONENTS / EINZELTEILE						
H.334		S-FIX-SUP	IX AISI 316		1 pc	88,70 /pc
H.335		S-BAR-830	IX AISI 316	830 mm	1 pc	60,00 /pc
		S-BAR-1050	IX AISI 316	1050 mm	1 pc	69,30 /pc
		S-BAR-1500	IX AISI 316	1500 mm	1 pc	88,70 /pc
		S-BAR-1625	IX AISI 316	1625 mm	1 pc	95,50 /pc
		S-BAR-2110	IX AISI 316	2110 mm	1 pc	115,00 /pc
H.336			AN	2000 mm	1 pc	308,00 /pc
		PRESA-2-PROFILO	AN	3000 mm	1 pc	430,30 /pc
			AN	 6000 mm	1 pc	774,30 /pc
H.337		S-FIX-VETRO-44	IX AISI 316		1 pc 	95,50 /pc
H.338		S-FIX-VETRO-60	IX AISI 316		1 pc 	103,50 /pc
H.339		PRESA-2-KIT-8	for glass 8+8+1,52		1 set	124,30 /set
		PRESA-2-KIT-10	for glass 10+10+1,52			
H.340		PRESA-2-TAPPO	AN		2 pcs	36,00 /set

POS.	PROD.	ART.	FIN.	Q.TÀ	EURO
	<p>PROJECT FIVE</p>				
					► BALAUSTR E PENSILINE 166
H.341		<p>PJ5-SET 1-D44</p> <ul style="list-style-type: none"> Set: n° 2 S-FIX-SUP (A) n° 2 S-BAR-830 (B) n° 2 S-FIX-INF-44 (C) n° 2 S-FIX-VETRO-44 (D) 	IX AISI 316	1 set 	773,30 /set
		<p>PJ5-SET 1-D60</p> <ul style="list-style-type: none"> Set: n° 2 S-FIX-SUP (A) n° 2 S-BAR-830 (B) n° 2 S-FIX-INF-60 (C) n° 2 S-FIX-VETRO-60 (D) 	IX AISI 316	1 set 	835,00 /set
H.342		<p>PJ5-SET 2-D44</p> <ul style="list-style-type: none"> Set: n° 2 S-FIX-SUP (A) n° 2 S-BAR-1050 (B) n° 2 S-FIX-INF-44 (C) n° 2 S-FIX-VETRO-44 (D) 	IX AISI 316	1 set 	791,30 /set
		<p>PJ5-SET 2-D60</p> <ul style="list-style-type: none"> Set: n° 2 S-FIX-SUP (A) n° 2 S-BAR-1050 (B) n° 2 S-FIX-INF-60 (C) n° 2 S-FIX-VETRO-60 (D) 	IX AISI 316	1 set 	853,30 /set
H.343		<p>PJ5-SET 3-D44</p> <ul style="list-style-type: none"> Set: n° 2 S-FIX-SUP (A) n° 2 S-BAR-1500 (B) n° 2 S-FIX-INF-44 (C) n° 2 S-FIX-VETRO-44 (D) 	IX AISI 316	1 set 	830,30 /set
		<p>PJ5-SET 3-D60</p> <ul style="list-style-type: none"> Set: n° 2 S-FIX-SUP (A) n° 2 S-BAR-1500 (B) n° 2 S-FIX-INF-60 (C) n° 2 S-FIX-VETRO-60 (D) 	IX AISI 316	1 set 	892,30 /set
H.344		<p>PJ5-SET 4-D60</p> <ul style="list-style-type: none"> Set: n° 2 S-FIX-SUP (A) n° 2 S-BAR-1625 (B) n° 2 S-FIX-INF-60 (C) n° 2 S-FIX-VETRO-60 (D) 	IX AISI 316	1 set 	906,00 /set
H.345		<p>PJ5-SET 5-D60</p> <ul style="list-style-type: none"> Set: n° 2 S-FIX-SUP (A) n° 2 S-BAR-2110 (B) n° 2 S-FIX-INF-60 (C) n° 2 S-FIX-VETRO-60 (D) 	IX AISI 316	1 set 	945,00 /set

- Confezioni industriali
- Industrial packaging
- Industrieverpackungen
- * Senza vellete
- * Without cover profiles
- * Ohne Abdeckungen
- *** Prezzo su richiesta
- *** Price on request
- *** Preis auf Anfrage

POS.	PROD.	ART.	FIN.	Q.TÀ	EURO
	<p>PROJECT FIVE</p> <p>set con attacco doppio a parete / set with double upper wall-rod connector / set mit doppel Wand-zugstangeverbindung oben</p>			► BALAUSTR E PENSILINE 168	
H.346		PJ5-44-DOP-SET 6 • Set: n° 1 S-FIX-DOPPIO (A) n° 2 S-BAR-830 (B) n° 2 S-FIX-INF-44 (C) n° 2 S-FIX-VETRO-44 (D)	IX AISI 316	1 set 	899,30/set
H.347		PJ5-44-DOP-SET 7 • Set: n° 2 S-FIX-DOPPIO (A) n° 2 S-BAR-1050 (B) n° 2 S-FIX-INF-44 (C) n° 2 S-FIX-VETRO-44 (D)	IX AISI 316	1 set 	917,30/set
H.348	<p>VETRO: 8+8+1.52 / 10+10+1.52 (PVB-SGP) STRATIFICATO TEMPERATO FORI VETRO Ø22mm</p>	PJ5-44-DOP-SET 8 • Set: n° 2 S-FIX-DOPPIO (A) n° 2 S-BAR-1500 (B) n° 2 S-FIX-INF-44 (C) n° 2 S-FIX-VETRO-44 (D)	IX AISI 316	1 set 	956,50/set
H.349		PJ5-60-DOP-SET 9 • Set: n° 2 S-FIX-DOPPIO (A) n° 2 S-BAR-1625 (B) n° 2 S-FIX-INF-60 (C) n° 2 S-FIX-VETRO-60 (D)	IX AISI 316	1 set 	1032,00/set
H.350	<p>VETRO: 8+8+1.52 / 10+10+1.52 (PVB-SGP) STRATIFICATO TEMPERATO FORI VETRO Ø22mm</p>	PJ5-60-DOP-SET 10 • Set: n° 2 S-FIX-DOPPIO (A) n° 2 S-BAR-2110 (B) n° 2 S-FIX-INF-60 (C) n° 2 S-FIX-VETRO-60 (D)	IX AISI 316	1 set 	1071,30/set

POS.	PROD.	ART.	FIN.	MIS.	Q.TÀ	EURO
COMPONENTI / COMPONENTS / EINZELTEILE						
H.351		S-FIX-SUP	IX AISI 316		1 pc	88,70 /pc
H.352		S-BAR-830	IX AISI 316	830 mm	1 pc	60,00 /pc
		S-BAR-1050	IX AISI 316	1050 mm	1 pc	69,30 /pc
		S-BAR-1500	IX AISI 316	1500 mm	1 pc	88,70 /pc
		S-BAR-1625	IX AISI 316	1625 mm	1 pc	95,50 /pc
		S-BAR-2110	IX AISI 316	2110 mm	1 pc	115,00 /pc
H.353		S-FIX-INF-44	IX AISI 316		1 pc 	143,70 /pc
H.354		S-FIX-INF-60	IX AISI 316		1 pc 	166,50 /pc
H.355		S-FIX-VETRO-44	IX AISI 316		1 pc 	95,50 /pc
H.356		S-FIX-VETRO-60	IX AISI 316		1 pc 	103,50 /pc
H.357		S-FIX-INF-44 SV	IX AISI 316		1 pc 	168,00 /pc
H.358		S-FIX-INF-60 SV	IX AISI 316		1 pc 	196,50 /pc

 • Prezzo su richiesta
 • Price on request
 • Preis auf Anfrage

*
 • Senza vellete
 • Without cover profiles
 • Ohne Abdeckungen

 • Prezzo su richiesta
 • Price on request
 • Preis auf Anfrage

POS.	PROD.	ART.	FIN.	MIS.	Q.TÀ	EURO
H.359	 D	S-FIX-VETRO-44 SV	IX AISI 316		1 pc 	110,30/pc
H.360	 D	S-FIX-VETRO-60 SV	IX AISI 316		1 pc 	123,00/pc
H.361		S-FIX-DOPPIO	IX AISI 316		1 pc	303,00/pc
H.362	 E	S-FIX-DOPPIO-V	IX AISI 316		1 pc	243,30/pc
H.363	 	S-DIST-TERMICO	Aluminium			***
H.364		S-FIX-ROS	IX AISI 316		1 pc	81,70/pc
H.365		S-BAR-PROL	IX AISI 316		1 pc	73,50/pc
H.366		S-BAR-ADAT	IX AISI 316		1 pc	70,30/pc

POS.	PROD.	ART.	FIN.	Q.TÀ	EURO
------	-------	------	------	------	------

TEKNO senza tiranti, sorretta dal basso / with bottom supports / ohne Zugstangen ▶ BALAUSTR E PENSILINE 174

H.367	 	TEKNO SET 1	IX	1 set	1268,00 /set
H.368	 	TEKNO SET 2	IX	1 set	1746,50 /set

- Confezioni industriali
- Industrial packaging
- Industrieverpackungen
- * Senza vellete
- Without cover profiles
- Ohne Abdeckungen
- *** Prezzo su richiesta
- Price on request
- Preis auf Anfrage

GUIDA TECNICA PER LA SCELTA DEL VOSTRO SISTEMA
TECHNICAL GUIDE FOR THE CHOICE OF YOUR SYSTEM
AUSWAHL VON DUSCHKABINEN NACH VORHANDENEN KRITERIEN

PARAPETTI PUNTUALI
RAILINGS WITH POINT FITTINGS
GANZGLASGELÄNDER
MIT PUNKTHALTERUNGEN

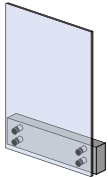

DISTANZIALI
REGOLABILI
ADJUSTABLE
POINT FITTINGS
VERSTELLBARE
PUNKTHALTERUNGEN

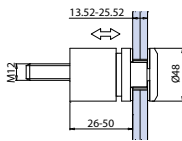

► 523

DISTANZIALI
CON COLLO
DI SOSTEGNO
POINT FITTINGS
WITH SUPPORT
PUNKTHALTERUNGEN
MIT HALS

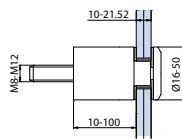

► 524

DISTANZIALI
MODULABILI
MODULAR POINT
FITTINGS
PUNKTHALTERUNGEN
MIT VERLÄNGERUNGEN

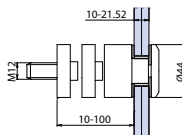

► 525

PUNTI DI FISSAGGIO
POINT FITTINGS
PUNKTHALTERUNGEN

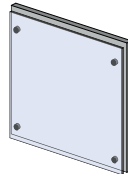

PUNTI DI FISSAGGIO
CON DISTANZIALE
SVASATI PER FISCHER
COUNTERSUNK
POINT FITTINGS
FLÄCHENBUNDIGE
PUNKTHALTERUNGEN

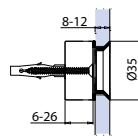

► 528

PUNTI DI FISSAGGIO
TESTA PIANA PER
FISCHER
POINT FITTINGS
FOR ANCHOR
PUNKTHALTERUNGEN
FÜR ANKER

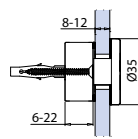

► 528

PUNTI DI FISSAGGIO
SVASATI E PIANI PER
BARRA FILETTATA
POINT FITTINGS
FOR THREADED BAR
PUNKTHALTERUNGEN
FÜR GEWINDESTANGE

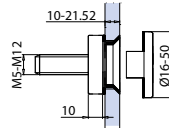

► 528

PUNTI DI FISSAGGIO
PER TARGHE
POINT FITTINGS
FOR PLATES
PUNKTHALTERUNGEN
FÜR WERBESCHILD

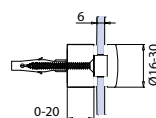

► 528

TAPPI DI FISSAGGIO
POINT FITTINGS
PUNKTHALTERUNGEN

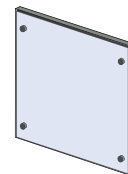

TAPPO PIANO
PER VITE
POINT FITTINGS
FOR SCREW
PUNKTHALTERUNGEN
FÜR SCHRAUBE

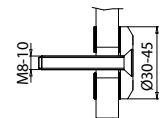

► 526

TAPPO PIANO
PER BARRA FILETTATA
POINT FITTINGS
FOR THREADED BAR
PUNKTHALTERUNGEN
FÜR GEWINDESTANGE

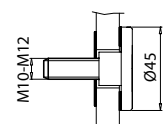

► 526

TAPPO PIANO
CON COLLO PER VITE
POINT FITTINGS
WITH SUPPORT FOR
SCREW
PUNKTHALTERUNGEN
MIT HALS FÜR
SCHRAUBE

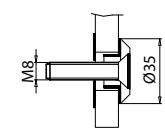

► 526

TAPPO PIANO CON COLLO
PER BARRA FILETTATA
POINT FITTINGS
WITH SUPPORT FOR
THREADED BAR
PUNKTHALTERUNGEN
MIT HALS FÜR
GEWINDESTANGE

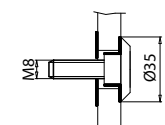

► 526

TAPPO SVASATO
PER VITE
COUNTERSUNK POINT
FITTINGS FOR CREW
FLÄCHENBUNDIGE
PUNKTHALTERUNGEN
FÜR SCHRAUB

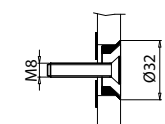

► 526

TAPPO SVASATO
PER BARRA FILETTATA
COUNTERSUNK POINT
FITTINGS FOR
THREADED BAR
FLÄCHENBUNDIGE
PUNKTHALTERUNGEN
GEWINDESTANGE

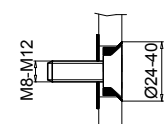

► 526

MORSETTI SENZA TACCA NEL VETRO
CLAMPS WITHOUT GLASS PREPARATION
KLEMMEN OHNE GLASBEARBEITUNG

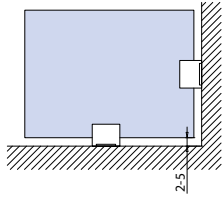

M-115/M-116/M-117

► 519

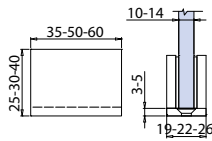

MORSETTI SENZA TACCA NEL VETRO PER VETRI SOLLEVATI
CLAMPS WITHOUT GLASS PREPARATION FOR RAISED GLASSES
KLEMMEN OHNE GLASBEARBEITUNG FÜR ANGEHOEBENE GLASSCHEIBEN

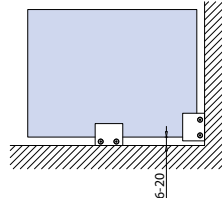

M-101/M-102
M-103 dx-sx

► 518

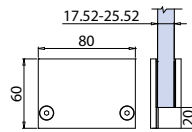

M-105/M-106 dx-sx
M-107/M-108 dx-sx

► 518-518

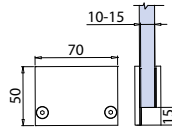

M-109/M-110 dx-sx

► 518-518

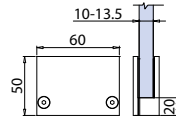

M-111/M-112

► 519

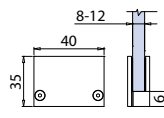

M-113

► 519

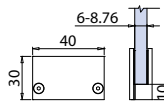

M-114

► 519

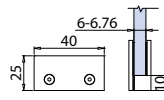

V-046/M-126
V-047/V-043

► 521-521

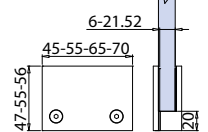

V-044/V-045/M-129

► 520

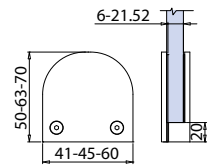

MORSETTI CON TACCA NEL VETRO
CLAMPS WITH GLASS PREPARATION
KLEMMEN MIT GLASBEARBEITUNG

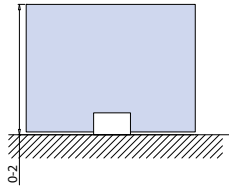

M-118/M-119/M-120

► 519

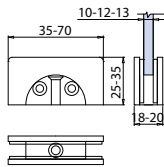

MQ-9

► 519

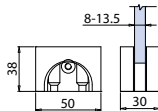

MORSETTI IN ZAMA E INOX
PER MONTANTI TUBOLARI
CLAMPS IN INOX/ZINC ALLOY FOR TUBES
KLEMMEN AUS ZAMAK/EDELSTAHL FÜR
ROHRE

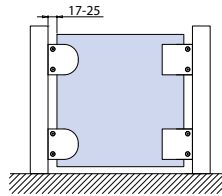

M-128/M-127/M-134

► 522

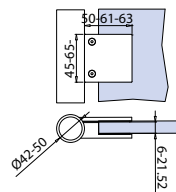

M-130/M-131

► 521

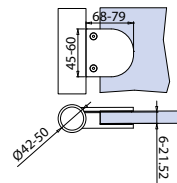

M-124/M-125

► 520

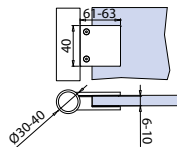

M-122

► 520

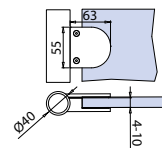

MORSETTI IN ZAMA E INOX
PER SPESSORI VARIABILI
CLAMPS IN INOX/ZINC ALLOY
FOR VARIABLE THICKNESSES
KLEMMEN AUS ZAMAK/EDELSTAHL
FÜR VARIABLE GLASSTÄRKEN

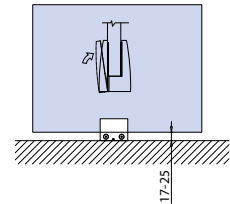

M-132 N/M-133 N

► 522

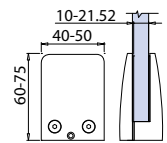

M-123

► 520

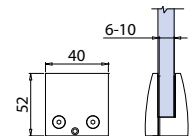

M-121

► 520

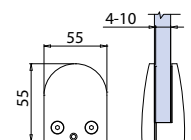

MORSETTI INOX VETRO-VETRO 180° E 90°
CLAMPS IN INOX GLASS TO GLASS 180°, 90°
KLEMMEN AUS EDELSTAHL
GLAS-GLAS 180°, 90°

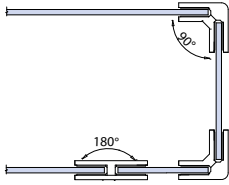

V-083-180 N
V-049-180 N

▶ 522

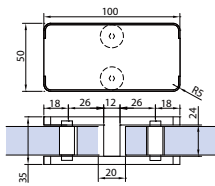

V-048-180

▶ 521

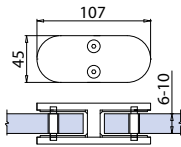

V-083-90 N

▶ 522

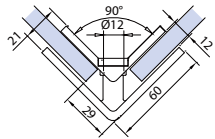

V-049-90 N

▶ 522

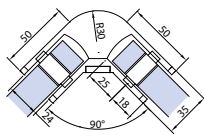

V-048-90

▶ 521

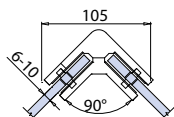

ACCESSORI PER SCALE
GLASS STAIRS SUPPORTS
GLASSTUFENHALTER

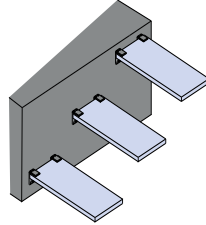

V-067/V-081

▶ 533-534

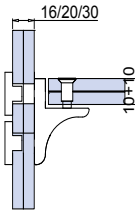
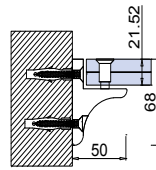

V-082/V-083

▶ 532

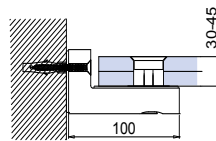
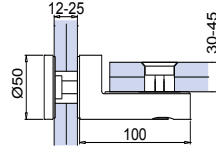

FISSAGGI PUNTUALI
POINT FITTINGS
PUNKTHALTERUNGEN

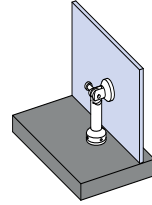

PG-145 F
PG-139 F
PG-120 F
PG-150 F



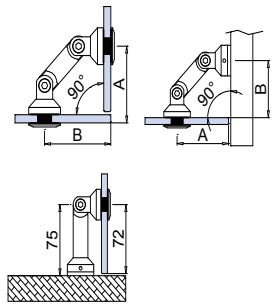



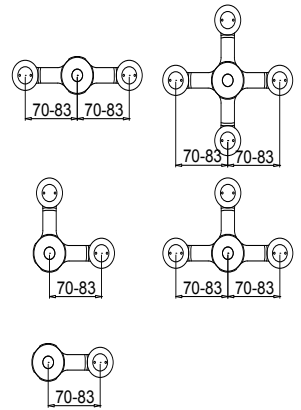

▶ 532







RA-101-104
RA-051-054



▶ 530



POS.	PROD.	ART.	MIS.		Q.TÀ	FIN.	EURO	FIN.	EURO
MORSETTI IN OTTONE <i>CLAMPS MATERIAL BRASS / KLEMMBESCHLÄGE MATERIAL MESSING</i>									
I.1		M-101	60 x 80 x 27 mm	Per vetro / For glass / Für Glas 25,52 mm	1 pc	CR	79,00 /pc	NS	81,30 /pc
I.2		M-102	60 x 80 x 23 mm	Per vetro / For glass / Für Glas 21,52 / 19 / 17,52 mm	1 pc	CR	75,30 /pc	NS	77,70 /pc
I.3		M-103 DX M-103 SX	60 x 80 x 23 mm	Per vetro / For glass / Für Glas 21,52 / 19 / 17,52 mm	1 pc	CR	80,70 /pc	NS	83,00 /pc
I.4		M-105	50 x 70 x 16,5 mm	Per vetro / For glass / Für Glas 15 / 13,52 / 12,76 / 12 mm	1 pc	CR	52,30 /pc	NS	54,70 /pc
I.5		M-106 DX M-106 SX	50 x 70 x 16,5 mm	Per vetro / For glass / Für Glas 15 / 13,52 / 12,76 / 12 mm	1 pc	CR	59,00 /pc	NS	61,00 /pc
I.6		M-107	50 x 70 x 13,5 mm	Per vetro / For glass / Für Glas 11,52 / 10,76 / 10,38 / 10 mm	1 pc	CR	50,30 /pc	NS	52,50 /pc
I.7		M-108 DX M-108 SX	50 x 70 x 13,5 mm	Per vetro / For glass / Für Glas 11,52 / 10,76 / 10,38 / 10 mm	1 pc	CR	59,00 /pc	NS	61,00 /pc
I.8		M-109	50 x 60 x 15,5 mm	Per vetro / For glass / Für Glas 13,52 / 12,76 / 12 / 11,52 / 10,76 / 10,38 / 10 mm	1 pc	CR	43,00 /pc	NS	44,00 /pc
I.9		M-110 DX M-110 SX	50 x 60 x 15,5 mm	Per vetro / For glass / Für Glas 13,52 / 12,76 / 12 / 11,52 / 10,76 / 10,38 / 10 mm	1 pc	CR	49,00 /pc	NS	50,00 /pc

POS.	PROD.	ART.	MIS.	Q.TÀ	FIN.	EURO	FIN.	EURO
I. 10		M-111	35 x 40 x 14 mm	Per vetro / For glass / Für Glas 12 / 11,52 / 10,76 / 10,38 / 10 mm	1 pc	CR 27,30 /pc	NS 28,30 /pc	
I. 11		M-112	35 x 40 x 12 mm	Per vetro / For glass / Für Glas 8 / 8,76 mm	1 pc	CR 28,30 /pc	NS 31,30 /pc	
I. 12		M-113	30 x 40 x 10 mm	Per vetro / For glass / Für Glas 8,76 / 8 / 6,76 / 6 mm	1 pc	CR 28,70 /pc	NS 30,00 /pc	
I. 13		M-114	25 x 40 x 8 mm	Per vetro / For glass / Für Glas 6,76 / 6 mm	1 pc	CR 22,30 /pc	NS 25,50 /pc	
I. 14		M-115	35 x 25 x 10 mm	Per vetro / For glass / Für Glas 6 / 8 mm	1 pc	CR 21,70 /pc	NS 21,70 /pc	
I. 15		M-116	50 x 30 x 13,5 mm	Per vetro / For glass / Für Glas 10 / 12 mm	1 pc	CR 28,00 /pc	NS 28,00 /pc	
						CP 28,00 /pc		
I. 16		M-117	60 x 40 x 14 mm	Per vetro / For glass / Für Glas 10 / 12 mm	1 pc	CR 47,30 /pc	NS 47,30 /pc	
I. 17		M-118	70 x 35 x 13 mm	Per vetro / For glass / Für Glas 8 / 10 / 12 mm	1 pc	CR 33,50 /pc	NS 33,50 /pc	
I. 18		M-120	35 x 25 x 10 mm	Per vetro / For glass / Für Glas 6 / 8 mm	1 pc	CR 24,30 /pc	NS 24,30 /pc	
I. 19		M-119	35 x 25 x 12 mm	Per vetro / For glass / Für Glas 8 / 10 mm	1 pc	CR 24,30 /pc	NS 24,30 /pc	
I. 20		MQ-9	50 x 38 mm	Per vetro / For glass / Für Glas 8 → 13,5 mm	1 pc	CR 25,50 /pc	NS 22,00 /pc	
						CP 24,50 /pc		

POS.	PROD.	ART.	MIS.	MIS.	Q.TÀ	FIN.	EURO	FIN.	EURO
MORSETTI IN ZAMA CLAMPS MATERIAL ZAMAK / KLEMMBESCHLÄGE MATERIAL ZAMAK									
I. 21		M-121	55 x 55 x 7,5 mm	Per vetro / For glass / Für Glas 4 / 10 mm	1 pc	CR	20,00 /pc	CP	21,30 /pc
I. 22		M-122	55 x 64 x 7,5 mm per tubolare / for tube / für Rohr Ø 40 mm	Per vetro / For glass / Für Glas 4 / 10 mm	1 pc	CR	23,00 /pc	CP	24,50 /pc
I. 23		M-123	40 x 52 x 9,5 mm	Per vetro / For glass / Für Glas 6 / 10 mm	1 pc	CR	17,30 /pc	CP	18,50 /pc
I. 24		M-124	40 x 63 x 9,5 mm per tubolare / for tube / für Rohr Ø 30 mm	Per vetro / For glass / Für Glas 6 / 10 mm	1 pc	CR	18,50 /pc	CP	19,50 /pc
I. 25		M-125	40 x 63 x 9,5 mm per tubolare / for tube / für Rohr Ø 40 mm	Per vetro / For glass / Für Glas 6 / 10 mm	1 pc	CR	18,50 /pc	CP	19,50 /pc

MORSETTI IN ACCIAIO INOX AISI 316 CLAMPS MATERIAL STAINLESS STEEL AISI 316 / KLEMMBESCHLÄGE MATERIAL EDELSTAHL AISI 316									
I. 26		V-044	41 x 50 x 12 mm	Per vetro / For glass / Für Glas 6 / 8 / 10 mm	1 pc	IX	31,30 /pc		
I. 27		V-045	45 x 63 x 14 mm	Per vetro / For glass / Für Glas 10,76 / 11,52 / 12 / 12,76 mm	1 pc	IX	42,00 /pc		
I. 28		M-129	70 x 60 x 24 mm	Per vetro / For glass / Für Glas 17,52 / 21,52 mm	1 pc	IX	60,30 /pc	IL	64,70 /pc

- Confezioni industriali
- Industrial packaging
- Industrieverpackungen

min

- Prezzi speciali per l'acquisto delle quantità minime indicate dell'articolo
NB eventuali riordini o aggiunte per completamenti se di quantità inferiore alla minima, saranno fatturati al prezzo normale
- Special prices for the purchase of the minimum quantities indicated of the article
Note Well: any reorders or additions for completions of quantity less than the minimum will be invoiced at the normal price
- Artikel mit Sonderpreisen bei Mindestabnahmemengen sind mit gekennzeichnet
Nachbestellungen oder Ergänzungen unter der Mindestabnahmemenge werden mit dem Normalpreis verrechnet

POS.	PROD.	ART.	MIS.	MIS.	Q.TÀ	FIN.	EURO	FIN.	EURO
I. 29		V-048-180	107 x 44 mm	Per vetro / For glass / Für Glas 6 / 8 / 10 mm	1 pc	IX	52,50 /pc		
I. 30		V-048-90	74 x 45 mm	Per vetro / For glass / Für Glas 6 / 8 / 10 mm	1 pc	IX	63,30 /pc		
I. 31		M-130	60 x 80 mm per tubolare / for tube / für Rohr Ø 50 mm	Per vetro / For glass / Für Glas 17,52 / 21,52 mm	1 pc	IX	64,50 /pc	IL	69,50 /pc
I. 32		M-131	68 x 45 mm per tubolare / for tube / für Rohr Ø 42 mm	Per vetro / For glass / Für Glas 6 / 12,76 mm	1 pc	IX	39,70 /pc	IL	44,00 /pc
I. 33		V-046	47 x 47 x 12 mm	Per vetro / For glass / Für Glas 6 / 8 / 10 mm	1 pc	IX	32,00 /pc		
I. 34		M-126	55 x 55 x 30 mm	Per vetro / For glass / Für Glas 8 / 10 / 11,52 / 13,52 mm	1 pc	IX	47,00 /pc	IL	51,00 /pc
I. 35		V-047	70 x 55 x 18 mm	Per vetro / For glass / Für Glas 12 / 12,76 / 16,76 / 17,52 mm	1 pc	IX	64,30 /pc		
I. 36		V-043	55 x 65 x 42 mm	Per vetro / For glass / Für Glas 17,52 / 21,52 mm	1 pc	IX	78,50 /pc	IL	81,70 /pc
		V-043	55 x 65 x 42 mm	Per vetro / For glass / Für Glas 17,52 / 21,52 mm	■ min 10 pcs	IX	67,00 /pc		
		V-043	55 x 65 x 42 mm	Per vetro / For glass / Für Glas 17,52 / 21,52 mm	■ min 30 pcs	IX	61,00 /pc		

POS.	PROD.	ART.	MIS.		Q.TÀ	FIN.	EURO	FIN.	EURO
I. 37		V-083-180 N	100 x 39 mm	Per vetro / For glass / Für Glas 8 / 12 mm	1 pc	IX	58,30 /pc	IL	62,30 /pc
I. 38		V-083-90 N	60 x 39 mm	Per vetro / For glass / Für Glas 8 / 12 mm	1 pc	IX	73,00 /pc	IL	79,00 /pc
I. 39		V-049-180 N	100 x 50 mm	Per vetro / For glass / Für Glas 17,52 / 21,52 mm	1 pc	IX	88,70 /pc	IL	97,30 /pc
I. 40		V-049-90 N	112 x 49 mm	Per vetro / For glass / Für Glas 17,52 / 21,52 mm	1 pc	IX	110,70 /pc	IL	116,70 /pc
I. 41		M-128	45 x 50 mm per tubolare / for tube / für Rohr Ø 42 mm	Per vetro / For glass / Für Glas 16 / 8 / 10 mm	1 pc	IX	37,30 /pc	IL	42,30 /pc
I. 42		M-127	61x55 mm per tubolare / for tube / für Rohr Ø 42 mm	Per vetro / For glass / Für Glas 8 / 10 / 11,52 / 13,52 mm	1 pc	IX	49,00 /pc	IL	53,70 /pc
I. 43		M-134	74 x 65 mm per tubolare / for tube / für Rohr Ø 50 mm	Per vetro / For glass / Für Glas 17,52 / 21,52 mm	1 pc	IX	69,50 /pc	IL	74,00 /pc
I. 44		M-132 N	40 x 60 mm	Per vetro / For glass / Für Glas 10 / 13,5 mm	1 pc	IX	49,50 /pc	IL	53,70 /pc
I. 45		M-133 N	50 x 75 mm	Per vetro / For glass / Für Glas 15 / 21,5 mm	1 pc	IX	56,50 /pc	IL	61,00 /pc









- Confezioni industriali
- Industrial packaging
- Industrieverpackungen

min

- Prezzi speciali per l'acquisto delle quantità minime indicate dell'articolo
NB eventuali riordini o aggiunte per completamenti se di quantità inferiore alla minima, saranno fatturati al prezzo normale
- Special prices for the purchase of the minimum quantities indicated of the article
Note Well: any reorders or additions for completions of quantity less than the minimum will be invoiced at the normal price
- Artikel mit Sonderpreisen bei Mindestabnahmemengen sind mit gekennzeichnet
Nachbestellungen oder Ergänzungen unter der Mindestabnahmemenge werden mit dem Normalpreis verrechnet

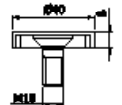
POS.	PROD.	ART.	MIS.	Q.TÀ	FIN.	EURO	
DISTANZIALI ORBITALI <i>ORBITAL POINT FITTINGS / VERSTELLBARE PUNKTHALTERUNGEN</i>							
I. 46		DR-048-30 	Ø 48 x H 26/31 mm	M12 x 80 Incluso / included / Enthalten	Per vetro / For glass / Für Glas 13,5 - 17,52 mm	1 pc	IX 106,00 /pc
		DR-048-30 	Ø 48 x H 26/31 mm	M12 x 80 Incluso / included / Enthalten	Per vetro / For glass / Für Glas 13,5 - 17,52 mm	■ min 40 pcs	IX 80,00 /pc
		<ul style="list-style-type: none"> • Vendibili solo in multipli di 2 • Min. package unit 2 pcs • Verpackungseinheit 2 Stk 					
I. 47		DR-048-35 	Ø 48 x H 26/31 mm	M12 x 80 Incluso / included / Enthalten	Per vetro / For glass / Für Glas 21,5 - 25,52 mm	1 pc	IX 109,30 /pc
		DR-048-35 	Ø 48 x H 26/31 mm	M12 x 80 Incluso / included / Enthalten	Per vetro / For glass / Für Glas 21,5 - 25,52 mm	■ min 40 pcs	IX 83,00 /pc
		<ul style="list-style-type: none"> • Vendibili solo in multipli di 2 • Min. package unit 2 pcs • Verpackungseinheit 2 Stk 					
I. 48		DR-048-50 	Ø 48 x H 40/45 mm		Per vetro / For glass / Für Glas 13,5 - 21,52 mm	1 pc	IX 79,50 /pc
		DR-048-50 	Ø 48 x H 40/45 mm		er vetro / For glass / Für Glas 13,5 - 21,52 mm	■ min 40 pcs	IX 71,50 /pc
		<ul style="list-style-type: none"> • Vendibili solo in multipli di 2 • Min. package unit 2 pcs • Verpackungseinheit 2 Stk 					
I. 49		D-CHIAVE DR-48	<ul style="list-style-type: none"> • Chiave per regolazione in profondità con vetro montato • Tool depth adjustment with installed glass • Schlüssel Tiefereinstellung mit eingebautem Glas 			1 pc	33,00 /pc
I. 50		T-12x150	M12 x 150 mm			1 pc	5,50 /pc
I. 51		DR-048-55 N 	Ø 48 x H 45/50 mm	M12 x 150 Incluso / included / Enthalten	Per vetro / For glass / Für Glas 13,5 - 21,52 mm	1 pc	IX 83,30 /pc
		DR-048-55 N 	Ø 48 x H 45/50 mm	M12 x 150 Incluso / included / Enthalten	er vetro / For glass / Für Glas 13,5 - 21,52 mm	■ min 40 pcs	IX 61,00 /pc
		<ul style="list-style-type: none"> • Vendibili solo in multipli di 2 • Min. package unit 2 pcs • Verpackungseinheit 2 Stk 					

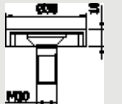
- Vendibili solo in multipli di 2
- Min. package unit 2 pcs
- Verpackungseinheit 2 Stk

POS.	PROD.	ART.	MIS.		Q.TÀ	FIN.	EURO
DISTANZIALI CON COLLO DI SOSTEGNO <i>POINT FITTINGS WITH SUPPORT / PUNKTHALTERUNGEN MIT HALS</i>							
I. 52		D-050-10 ⚠	Ø 50 x H 10 mm	Per vetro / For glass / Für Glas 10 - 21,5 mm	1 pc	IX	70,70 /pc
		D-050-60 ⚠	Ø 50 x H 60 mm	Per vetro / For glass / Für Glas 10 - 21,5 mm	1 pc	IX	106,00 /pc
		D-050-80 ⚠	Ø 50 x H 80 mm	Per vetro / For glass / Für Glas 10 - 21,5 mm	1 pc	IX	118,50 /pc
I. 53		D-040-10 ⚠	Ø 40 x H 10 mm	Per vetro / For glass / Für Glas 10 - 21,5 mm	1 pc	IX	39,30 /pc
		D-040-25 ⚠	Ø 40 x H 25 mm	Per vetro / For glass / Für Glas 10 - 21,5 mm	1 pc	IX	46,30 /pc
		D-040-25 ⚠	Ø 40 x H 25 mm	Per vetro / For glass / Für Glas 10 - 21,5 mm	■ min 40 pcs	IX	34,00 /pc
		D-040-45 ⚠	Ø 40 x H 45 mm	Per vetro / For glass / Für Glas 10 - 21,5 mm	1 pc	IX	53,00 /pc
		D-040-45 ⚠	Ø 40 x H 45 mm	Per vetro / For glass / Für Glas 10 - 21,5 mm	■ min 40 pcs	IX	40,30 /pc
		D-040-60	Ø 40 x H 60 mm	Per vetro / For glass / Für Glas 10 - 21,5 mm	1 pc	IX	70,00 /pc
		D-040-80	Ø 40 x H 80 mm	Per vetro / For glass / Für Glas 10 - 21,5 mm	1 pc	IX	74,30 /pc
		D-040-100	Ø 40 x H 100 mm	Per vetro / For glass / Für Glas 10 - 21,5 mm	1 pc	IX	81,70 /pc
I. 54	 M12x30	V-10X25	M 12 x 30 mm		1 pc		5,70 /pc
I. 55	 	TA-051-CF2 OPTIONAL	Ø 40 x H 8 mm	Tappo Endcap Endkappe	■ 2 pcs	IX	40,30 /2 pc
I. 56	 	TA-052-CF2 OPTIONAL	Ø 30 x H 8 mm	Tappo Endcap Endkappe	■ 2 pcs	IX	36,30 /2 pc
I. 57		D-030-10 ⚠	Ø 30 x H 10 mm	Per vetro / For glass / Für Glas 10 - 17,5 mm	1 pc	IX	32,00 /pc
		D-030-20 ⚠	Ø 30 x H 20 mm	Per vetro / For glass / Für Glas 10 - 17,5 mm	1 pc	IX	36,70 /pc
		D-030-30 ⚠	Ø 30 x H 30 mm	Per vetro / For glass / Für Glas 10 - 17,5 mm	1 pc	IX	38,30 /pc
		D-030-30 ⚠	Ø 30 x H 30 mm	Per vetro / For glass / Für Glas 10 - 17,5 mm	■ min 40 pcs	IX	28,70 /pc
		D-030-40 ⚠	Ø 30 x H 40 mm	Per vetro / For glass / Für Glas 10 - 17,5 mm	1 pc	IX	42,50 /pc

■ Confezioni industriali
■ Industrial packaging
■ Industrieverpackungen

■ **min**
■ Prezzi speciali per l'acquisto delle quantità minime indicate dell'articolo
NB eventuali riordini o aggiunte per completamenti se di quantità inferiore alla minima, saranno fatturati al prezzo normale
■ Special prices for the purchase of the minimum quantities indicated of the article
Note Well: any reorders or additions for completions of quantity less than the minimum will be invoiced at the normal price
■ Artikel mit Sonderpreisen bei Mindestabnahmemengen sind mit gekennzeichnet
Nachbestellungen oder Ergänzungen unter der Mindestabnahmemenge werden mit dem Normalpreis verrechnet



POS.	PROD.	ART.	MIS.		Q.TÀ	FIN.	EURO
I. 58		D-016-10 ⚠	Ø 16 x H 10 mm	Per vetro / For glass / Für Glas 4 - 8 mm	1 pc	IX	49,50 /pc
		DS-016-10 ⚠	Ø 16 x H 10 mm	Per vetro / For glass / Für Glas 4 - 8 mm	1 pc	IX	58,00 /pc

DISTANZIALI ORBITALI E MODULABILI

ORBITAL AND MODULAR POINT FITTINGS / VERSTELLBARE PUNKTHALTERUNGEN



I. 59		DP-044-10 ⚠	Ø 45 x H 10 mm	Per vetro / For glass / Für Glas 10 - 21,5 mm	1 pc	IX	44,70 /pc
		DP-044-20 ⚠	Ø 45 x H 20 mm	Per vetro / For glass / Für Glas 10 - 21,5 mm	1 pc	IX	57,30 /pc
		DP-044-30 ⚠	Ø 45 x H 30 mm	Per vetro / For glass / Für Glas 10 - 21,5 mm	1 pc	IX	53,00 /pc
		DP-044-40 ⚠	Ø 45 x H 40 mm	Per vetro / For glass / Für Glas 10 - 21,5 mm	1 pc	IX	72,30 /pc
		DP-044-60 ⚠	Ø 45 x H 60 mm	Per vetro / For glass / Für Glas 10 - 21,5 mm	1 pc	IX	85,00 /pc
		DP-044-70 ⚠	Ø 45 x H 70 mm	Per vetro / For glass / Für Glas 10 - 21,5 mm	1 pc	IX	96,50 /pc
		DP-044-100 ⚠	Ø 45 x H 100 mm	Per vetro / For glass / Für Glas 10 - 21,5 mm	1 pc	IX	122,00 /pc

OPTIONAL

I. 60		D-CHIAVE-REG	Ø 35-60 mm		1 pc		150,00 /pc
I. 61		D-CHIAVE-30-35	Ø 30-35 mm		1 pc		76,00 /pc
I. 62		D-CHIAVE-40-45	Ø 40-45 mm		1 pc		76,00 /pc









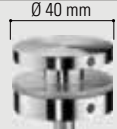

OPTIONAL PER DISTANZIALI DP-044

OPTIONAL POINT FITTINGS DP-044 / OPTIONAL FÜR PUNKTHALTERUNGEN DP-044











I. 63		TA-032	H 30 mm		1 pc	IX	38,30 /pc
I. 64		TA-030			1 pc		22,30 /pc
I. 65		TA-031	Ø 44 x H 10 mm		1 pc	IX	52,00 /pc

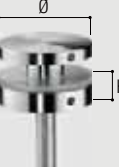

- Vendibili solo in multipli di 2
- Min. package unit 2 pcs
- Verpackungseinheit 2 Stk

POS.	PROD.	ART.	MIS.		Q.TÀ	FIN.	EURO
PUNTI DI FISSAGGIO <i>POINT HOLDERS / PUNKTHALTERUNGEN</i>							
I. 66		DP-050-10 ⚠	Ø 50 x H 10 mm	Per vetro / For glass / Für Glas 8 → 21,5 mm	1 pc	IX	61,00 /pc
I. 67		DS-045-10 ⚠	Ø 45 x H 10 mm	Per vetro / For glass / Für Glas 8 → 21,5 mm	1 pc	IX	82,30 /pc
I. 68		DP-040-10 ⚠	Ø 40 x H 10 mm	Per vetro / For glass / Für Glas 8 → 21,5 mm	1 pc	IX	54,30 /pc
		DS-040-10 ⚠	Ø 40 x H 10 mm	Per vetro / For glass / Für Glas 10 → 21,5 mm	1 pc	IX	62,30 /pc
I. 69		DP-030-10 ⚠	Ø 30 x H 10 mm	Per vetro / For glass / Für Glas 6 - 155 mm	1 pc	IX	45,30 /pc
		DS-030-10 ⚠	Ø 30 x H 10 mm	Per vetro / For glass / Für Glas 10 → 21,5 mm	1 pc	IX	56,30 /pc
		DSV-030-10 ⚠	Ø 30 x H 10 mm	Per vetro / For glass / Für Glas 10 → 21,5 mm	1 pc	IX	57,00 /pc
I. 70		TA-020	Ø 30 x H 6 mm	Per foro vetro / For glass hole / Für Glasbohrung Ø 15 mm	1 pc	IX	31,00 /pc
I. 71		TA-011/10MA /12MA	Ø 40 x H 16,4 mm M10 / M12	Per foro vetro / For glass hole / Für Glasbohrung Ø 31 / 31,5 mm	1 pc	IX	44,00 /pc
I. 72		TA-012	Ø 32 x H 10 mm	Per foro vetro / For glass hole / Für Glasbohrung Ø 26,5 / 27 mm	1 pc	IX	37,30 /pc
I. 73		TA-013	Ø 32 x H 10 mm	Per foro vetro / For glass hole / Für Glasbohrung Ø 26,5 / 27 mm	1 pc	IX	37,30 /pc
I. 74		TA-014	Ø 24 x H 8 mm	Per foro vetro / For glass hole / Für Glasbohrung Ø 14,5 / 15 mm	1 pc	IX	32,50 /pc
I. 75		TA-015	Ø 35 x H 12 mm	Per foro vetro / For glass hole / Für Glasbohrung Ø 16 mm	1 pc	IX	32,50 /pc
I. 76							

- ⚠
- Vendibili solo in multipli di 2
 - Min. package unit 2 pcs
 - Verpackungseinheit 2 Stk

POS.	PROD.	ART.	MIS.	Q.TÀ	FIN.	EURO
I. 77		TA-017	Ø 35 x H 12 mm	Per foro vetro / For glass hole / Für Glasbohrung Ø 22 mm	1 pc	IX 32,50 /pc
I. 78		TA-018/10MA /12MA	Ø 45 x H 18 mm M10 / M12	Per foro vetro / For glass hole / Für Glasbohrung Ø 22 mm	1 pc	IX 51,30 /pc
I. 79		TA-019	Ø 40 x H 8 mm	Per foro vetro / For glass hole / Für Glasbohrung Ø 15 mm	1 pc	IX 32,50 /pc
OPTIONAL						
I. 80		DP-016-10	Ø 16 x H 10 mm	Per vetro / For glass / Für Glas 4 - 6 mm	1 pc	IX 41,50 /pc
I. 81		TA-048-CF2 OPTIONAL	Ø 48 x H 9 mm	Tappo Endcap Endkappe	■ 2 pcs	IX 86,30 /2 pc
I. 82		PG-20	Ø 35 x H 10,5 / 13 mm		1 pc	IX 49,00 /pc
I. 83		PG-21	H 8 mm		1 pc	IX 16,30 /pc
I. 84		PG-CHIAVE			1 pc	IX 41,70 /pc
I. 85		V-058	19x19 x 21 mm		1 pc	CR 36,00 /pc
I. 86		TA-022	Ø 19 mm		10 pc	CR 99,30 /10 pc
I. 87		TA-023	Ø 24 mm		10 pc	CR 109,50 /10 pc
I. 88		TA-024-CF4	Ø 15 x 21 mm		■ 4 pcs	CR 57,70 /4 pc

POS.	PROD.	ART.	MIS.	MIS.	Q.TÀ	FIN.	EURO
I. 89		LAM-8330A 4A	Ø 24 x H 22 mm	Per vetro / For glass / Für Glas 8 - 10 mm	1 pc		37,30 /pc
I. 90		LAM-8300A 5	Ø 30 mm	Per vetro / For glass / Für Glas 8 mm	1 pc		32,00 /pc
I. 91		LAM-8300A 9A-DS	Ø 35 x H 6 mm	Per vetro / For glass / Für Glas 10 - 12 mm	1 pc		57,00 /pc
I. 92		LAM-8300A 9C-DS	Ø 35 x H 10,5 → 12,5 mm	Per vetro / For glass / Für Glas 10 - 12 mm	1 pc		70,70 /pc
I. 93		LAM-8300A 9E-DS	Ø 35 x H 14 → 18 mm	Per vetro / For glass / Für Glas 10 - 12 mm	1 pc		79,30 /pc
I. 94		LAM-8330A 9G-DS	Ø 35 x H 22 → 26 mm	Per vetro / For glass / Für Glas 10 - 12 mm	1 pc		83,00 /pc
I. 95		LAM-8300A 9A	Ø 35 x H 6 mm	Per vetro / For glass / Für Glas 10 - 12 mm	1 pc		44,00 /pc
I. 96		LAM-8300A 9C	Ø 35 x H 10,5 → 12,5 mm	Per vetro / For glass / Für Glas 10 - 12 mm	1 pc		59,30 /pc
I. 97		LAM-8300A 9E	Ø 35 x H 14 → 18 mm	Per vetro / For glass / Für Glas 10 - 12 mm	1 pc		77,50 /pc
I. 98		LAM-8300A 9G	Ø 35 x H 18 → 22 mm	Per vetro / For glass / Für Glas 10 - 12 mm	1 pc		73,30 /pc

POS.	PROD.	ART.	MIS.	Q.TÀ	FIN.	EURO
RAGNETTI CON FISSAGGI PUNTUALI <i>SPIDERS WITH POINT HOLDERS / SPINNEN MIT PUNKTHALTER</i>						
I. 99		RA-011	<ul style="list-style-type: none"> Set con tappo piano Set with clamping disc Set mit aufliegendem punkthalter 	Ø 32 mm	Per vetro / For glass / Für Glas 8 - 12 mm	1 pc IX 110,70 /pc
		RA-011-S	<ul style="list-style-type: none"> Set con tappo svasato Set with countersunk disc Set mit versenktem punkthalter 	Ø 32 mm	Per vetro / For glass / Für Glas 8 - 12 mm	1 pc IX 119,30 /pc
		RA-011/P	<ul style="list-style-type: none"> Solo piastra Only spider Nur spinne 		Per vetro / For glass / Für Glas 8 - 12 mm	1 pc IX 62,30 /pc
I. 100		RA-010	<ul style="list-style-type: none"> Set con tappo piano Set with clamping disc Set mit aufliegendem punkthalter 	Ø 32 mm	Per vetro / For glass / Für Glas 8 - 12 mm	1 pc IX 164,00 /pc
		RA-010-S	<ul style="list-style-type: none"> Set con tappo svasato Set with countersunk disc Set mit versenktem punkthalter 	Ø 32 mm	Per vetro / For glass / Für Glas 8 - 12 mm	1 pc IX 177,50 /pc
		RA-010/P	<ul style="list-style-type: none"> Solo piastra Only spider Nur spinne 		Per vetro / For glass / Für Glas 8 - 12 mm	1 pc IX 63,30 /pc
I. 101		RA-012	<ul style="list-style-type: none"> Set con tappo piano Set with clamping disc Set mit aufliegendem punkthalter 	Ø 32 mm	Per vetro / For glass / Für Glas 8 - 12 mm	1 pc IX 157,00 /pc
		RA-012-S	<ul style="list-style-type: none"> Set con tappo svasato Set with countersunk disc Set mit versenktem punkthalter 	Ø 32 mm	Per vetro / For glass / Für Glas 8 - 12 mm	1 pc IX 176,00 /pc
		RA-012/P	<ul style="list-style-type: none"> Solo piastra Only spider Nur spinne 		Per vetro / For glass / Für Glas 8 - 12 mm	1 pc IX 55,70 /pc
I. 102		RA-013	<ul style="list-style-type: none"> Set con tappo piano Set with clamping disc Set mit aufliegendem punkthalter 	Ø 32 mm	Per vetro / For glass / Für Glas 8 - 12 mm	1 pc IX 227,30 /pc
		RA-013-S	<ul style="list-style-type: none"> Set con tappo svasato Set with countersunk disc Set mit versenktem punkthalter 	Ø 32 mm	Per vetro / For glass / Für Glas 8 - 12 mm	1 pc IX 247,70 /pc
		RA-013/P	<ul style="list-style-type: none"> Solo piastra Only spider Nur spinne 		Per vetro / For glass / Für Glas 8 - 12 mm	1 pc IX 74,30 /pc
I. 103		RA-014	<ul style="list-style-type: none"> Punto di fissaggio per spider Fixing point for spider Punkthalter für Spinnernarmer 	Ø 35 mm		1 pc IX 62,30 /pc
I. 104		RA-104	<ul style="list-style-type: none"> Piastra a 4 punti di fissaggio 360° Spider 4 arm 360° Spinne 4 arm 360° 	Ø 35 mm	Per vetro / For glass / Für Glas 8 - 14 mm	1 pc IX 334,50 /pc
		RA-104/P	<ul style="list-style-type: none"> Solo piastra Only spider Nur spinne 		Per vetro / For glass / Für Glas 8 - 14 mm	1 pc IX 94,50 /pc
I. 105		RA-054	<ul style="list-style-type: none"> Piastra a 4 punti di fissaggio 360° Spider 4 arm 360° Spinne 4 arm 360° 	Ø 30 mm	Per vetro / For glass / Für Glas 8 - 14 mm	1 pc IX 323,70 /pc
		RA-054/P	<ul style="list-style-type: none"> Solo piastra Only spider Nur spinne 		Per vetro / For glass / Für Glas 8 - 14 mm	1 pc IX 82,30 /pc



POS.	PROD.	ART.	MIS.	Q.TÀ	FIN.	EURO
I. 106		RA-103	<ul style="list-style-type: none"> Piastra a 3 punti di fissaggio 90° Spider 3 arm 90° Spinne 3 arm 90° 	Ø 35 mm	Per vetro / For glass / Für Glas 8 - 14 mm	1 pc IX 267,70 /pc
		RA-103/P	<ul style="list-style-type: none"> Solo piastra Only spider Nur spinne 		Per vetro / For glass / Für Glas 8 - 14 mm	1 pc IX 87,30 /pc
I. 107		RA-053	<ul style="list-style-type: none"> Piastra a 3 punti di fissaggio 90° Spider 3 arm 90° Spinne 3 arm 90° 	Ø 30 mm	Per vetro / For glass / Für Glas 8 - 14 mm	1 pc IX 262,00 /pc
		RA-053/P	<ul style="list-style-type: none"> Solo piastra Only spider Nur spinne 		Per vetro / For glass / Für Glas 8 - 14 mm	1 pc IX 81,00 /pc
I. 108		RA-100	<ul style="list-style-type: none"> Piastra a 2 punti di fissaggio 90° Spider 2 arm 90° Spinne 2 arm 90° 	Ø 35 mm	Per vetro / For glass / Für Glas 8 - 14 mm	1 pc IX 202,50 /pc
		RA-100/P	<ul style="list-style-type: none"> Solo piastra Only spider Nur spinne 		Per vetro / For glass / Für Glas 8 - 14 mm	1 pc IX 82,30 /pc
I. 109		RA-050	<ul style="list-style-type: none"> Piastra a 2 punti di fissaggio 90° Spider 2 arm 90° Spinne 2 arm 90° 	Ø 30 mm	Per vetro / For glass / Für Glas 8 - 14 mm	1 pc IX 196,70 /pc
		RA-050/P	<ul style="list-style-type: none"> Solo piastra Only spider Nur spinne 		Per vetro / For glass / Für Glas 8 - 14 mm	1 pc IX 76,00 /pc
I. 110		RA-102	<ul style="list-style-type: none"> Piastra a 2 punti di fissaggio 90° Spider 2 arm 90° Spinne 2 arm 90° 	Ø 35 mm	Per vetro / For glass / Für Glas 8 - 14 mm	1 pc IX 191,30 /pc
		RA-102/P	<ul style="list-style-type: none"> Solo piastra Only spider Nur spinne 		Per vetro / For glass / Für Glas 8 - 14 mm	1 pc IX 80,00 /pc
I. 111		RA-052	<ul style="list-style-type: none"> Piastra a 2 punti di fissaggio 90° Spider 2 arm 90° Spinne 2 arm 90° 	Ø 30 mm	Per vetro / For glass / Für Glas 8 - 14 mm	1 pc IX 182,00 /pc
		RA-052/P	<ul style="list-style-type: none"> Solo piastra Only spider Nur spinne 		Per vetro / For glass / Für Glas 8 - 14 mm	1 pc IX 69,70 /pc
I. 112		RA-101	<ul style="list-style-type: none"> Piastra a 1 punto di fissaggio 90° Spider 1 arm 90° Spinne 1 arm 90° 	Ø 35 mm	Per vetro / For glass / Für Glas 8 - 14 mm	1 pc IX 126,70 /pc
		RA-101/P	<ul style="list-style-type: none"> Solo piastra Only spider Nur spinne 		Per vetro / For glass / Für Glas 8 - 14 mm	1 pc IX 70,30 /pc
I. 113		RA-051	<ul style="list-style-type: none"> Piastra a 1 punto di fissaggio 90° Spider 1 arm 90° Spinne 1 arm 90° 	Ø 30 mm	Per vetro / For glass / Für Glas 8 - 14 mm	1 pc IX 122,00 /pc
		RA-051/P	<ul style="list-style-type: none"> Solo piastra Only spider Nur spinne 		Per vetro / For glass / Für Glas 8 - 14 mm	1 pc IX 65,00 /pc



■ Confezioni industriali
Industrial packaging
Industrieverpackungen

■ min
Prezzi speciali per l'acquisto delle quantità minime indicate dell'articolo
NB eventuali riordini o aggiunte per completamenti se di quantità inferiore alla minima, saranno fatturati al prezzo normale
Special prices for the purchase of the minimum quantities indicated of the article
Note Well: any reorders or additions for completions of quantity less than the minimum will be invoiced at the normal price
Artikel mit Sonderpreisen bei Mindestabnahmemengen sind mit gekennzeichnet
Nachbestellungen oder Ergänzungen unter der Mindestabnahmemenge werden mit dem Normalpreis verrechnet

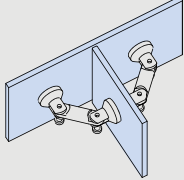
POS.	PROD.	ART.	MIS.	Q.TÀ	FIN.	EURO
PIVOTING SYSTEM						
PG-120 F						
I. 114		PG-120 F-3011	52,5 mm	1 pc	IX	91,00 /pc
		PG-120 F-3011	52,5 mm	■ min 10 pcs	IX	77,50 /pc
		PG-120 F-3012	60 mm	1 pc	IX	91,00 /pc
		PG-120 F-3012	60 mm	■ min 10 pcs	IX	77,50 /pc
		PG-120 F-3013	82 mm	1 pc	IX	91,00 /pc
		PG-120 F-3013	82 mm	■ min 10 pcs	IX	77,50 /pc
		PG-120 F-3014	103 mm	1 pc	IX	91,00 /pc
		PG-120 F-3014	103 mm	■ min 10 pcs	IX	77,50 /pc
<ul style="list-style-type: none"> • Se non specificato l'art. PG-120 F viene fornito standard con l'asta di connessione da 60 mm. • If not specified the art. PG-120 F is supplied standard with connecting rod of 60 mm • Falls nicht anders spezifiziert, wird Artikel PG-120 F mit standard Verbindungsachse 60 mm geliefert 						







PG-139 F						
I. 115		PG-139 F-3011	52,5 mm	1 pc	IX	91,00 /pc
		PG-139 F-3011	52,5 mm	■ min 10 pcs	IX	77,50 /pc
		PG-139 F-3012	60 mm	1 pc	IX	91,00 /pc
		PG-139 F-3012	60 mm	■ min 10 pcs	IX	77,50 /pc
		PG-139 F-3013	82 mm	1 pc	IX	91,00 /pc
		PG-139 F-3013	82 mm	■ min 10 pcs	IX	77,50 /pc
		PG-139 F-3014	103 mm	1 pc	IX	91,00 /pc
		PG-139 F-3014	103 mm	■ min 10 pcs	IX	77,50 /pc
<ul style="list-style-type: none"> • Se non specificato l'art. PG-120 F viene fornito standard con l'asta di connessione da 60 mm. • If not specified the art. PG-120 F is supplied standard with connecting rod of 60 mm • Falls nicht anders spezifiziert, wird Artikel PG-120 F mit standard Verbindungsachse 60 mm geliefert 						





POS.	PROD.	ART.	MIS.	Q.TÀ	FIN.	EURO
PG-145						
I. 116		PG-145 F		1 pc	IX	99,00 /pc
		PG-145 F		■ min 10 pcs	IX	77,50 /pc
PG-150						
I. 117		PG-150 F		1 pc	IX	197,50 /pc
		PG-150 F		■ min 10 pcs	IX	154,30 /pc
I. 118		PG-CHIAVE		1 pc	IX	41,70 /pc

ACCESSORI PER SCALE GLASS STAIRS SUPPORTS / GLASSTUFENHALTER						
I. 119		V-082		1 pc	IX	165,50 /pc
I. 120		V-083		1 pc	IX	135,70 /pc
I. 121						
I. 122						

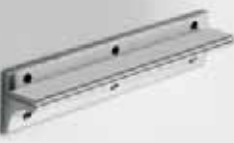
- Confezioni industriali
- Industrial packaging
- Industrieverpackungen

- **min**
- Prezzi speciali per l'acquisto delle quantità minime indicate dell'articolo
NB eventuali riordini o aggiunte per completamenti se di quantità inferiore alla minima, saranno fatturati al prezzo normale
- Special prices for the purchase of the minimum quantities indicated of the article
Note Well: any reorders or additions for completions of quantity less than the minimum will be invoiced at the normal price
- Artikel mit Sonderpreisen bei Mindestabnahmemengen sind mit gekennzeichnet
Nachbestellungen oder Ergänzungen unter der Mindestabnahmemenge werden mit dem Normalpreis verrechnet

POS.	PROD.	ART.	MIS.	Q.TÀ	FIN.	EURO
I. 123		V-072	35 mm	Per vetro / For glass / Für Glas 8+10+8+2 x (1,52 PVB) 10+10+ 8+2 x (1,52 PVB) 8+10+8+2 x (0,76 PVB) 10+10+ 8+2 x (0,76 PVB)	1 pc	NS 106,50 /pc
I. 124		V-074	35 mm	Per vetro / For glass / Für Glas 8+10+8+2 x (1,52 PVB) 10+10+ 8+2 x (1,52 PVB) 8+10+8+2 x (0,76 PVB) 10+10+ 8+2 x (0,76 PVB)	1 pc	NS 137,30 /pc
I. 125		V-067	35 mm	Per vetro / For glass / Für Glas 8+10+8+2 x (1,52 PVB) 10+10+ 8+2 x (1,52 PVB) 8+10+8+2 x (0,76 PVB) 10+10+ 8+2 x (0,76 PVB)	1 pc	NS 95,30 /pc
I. 126		V-069	35 mm	Per vetro / For glass / Für Glas 8+10+8+2 x (1,52 PVB) 10+10+ 8+2 x (1,52 PVB) 8+10+8+2 x (0,76 PVB) 10+10+ 8+2 x (0,76 PVB)	1 pc	NS 126,30 /pc
I. 127		V-071	35 mm	Per vetro / For glass / Für Glas 8+10+8+2 x (1,52 PVB) 10+10+ 8+2 x (1,52 PVB) 8+10+8+2 x (0,76 PVB) 10+10+ 8+2 x (0,76 PVB)	1 pc	NS 98,70 /pc
I. 128		V-073	35 mm	Per vetro / For glass / Für Glas 8+10+8+2 x (1,52 PVB) 10+10+ 8+2 x (1,52 PVB) 8+10+8+2 x (0,76 PVB) 10+10+ 8+2 x (0,76 PVB)	1 pc	NS 126,70 /pc
I. 129		V-076	300 mm	Per vetro / For glass / Für Glas 8+10+8+2 x (1,52 PVB) 10+10+ 8+2 x (1,52 PVB) 8+10+8+2 x (0,76 PVB) 10+10+ 8+2 x (0,76 PVB)	1 pc	NS 273,50 /pc
I. 130		V-078	300 mm	Per vetro / For glass / Für Glas 8+10+8+2 x (1,52 PVB) 10+10+ 8+2 x (1,52 PVB) 8+10+8+2 x (0,76 PVB) 10+10+ 8+2 x (0,76 PVB)	1 pc	NS 377,30 /pc

POS.	PROD.	ART.	MIS.	Q.TÀ	FIN.	EURO
I. 131		V-075	300 mm	Per vetro / For glass / Für Glas 8+10+8+2 x (1,52 PVB) 10+10+ 8+2 x (1,52 PVB) 8+10+8+2 x (0,76 PVB) 10+10+ 8+2 x (0,76 PVB)	1 pc	NS 266,50 /pc
I. 132		V-077	300 mm	Per vetro / For glass / Für Glas 8+10+8+2 x (1,52 PVB) 10+10+ 8+2 x (1,52 PVB) 8+10+8+2 x (0,76 PVB) 10+10+ 8+2 x (0,76 PVB)	1 pc	NS 366,30 /pc
I. 133		V-079	300 mm	Per vetro / For glass / Für Glas 8+10+8+2 x (1,52 PVB) 10+10+ 8+2 x (1,52 PVB) 8+10+8+2 x (0,76 PVB) 10+10+ 8+2 x (0,76 PVB)	1 pc	NS 247,70 /pc
I. 134		V-081	300 mm	Per vetro / For glass / Für Glas 8+10+8+2 x (1,52 PVB) 10+10+ 8+2 x (1,52 PVB) 8+10+8+2 x (0,76 PVB) 10+10+ 8+2 x (0,76 PVB)	1 pc	NS 333,30 /pc



LAV-030 | LAV-030-M

LAVORAZIONE STIPITI P-030 CON P-033 PER FORI CERNIERA E CONTROPIASTRA SERRATURA - PROFILE PREPARATION P-030 WITH P-033 - PROFILBEARBEITUNG P-030 MIT P-033

LAVORAZIONI POSSIBILI SONO SOLO STANDARD - ONLY STANDARD PROFILE PREPARATION AVAILABLE
NUR STANDARD PROFILBEARBEITUNG LIEFERBAR

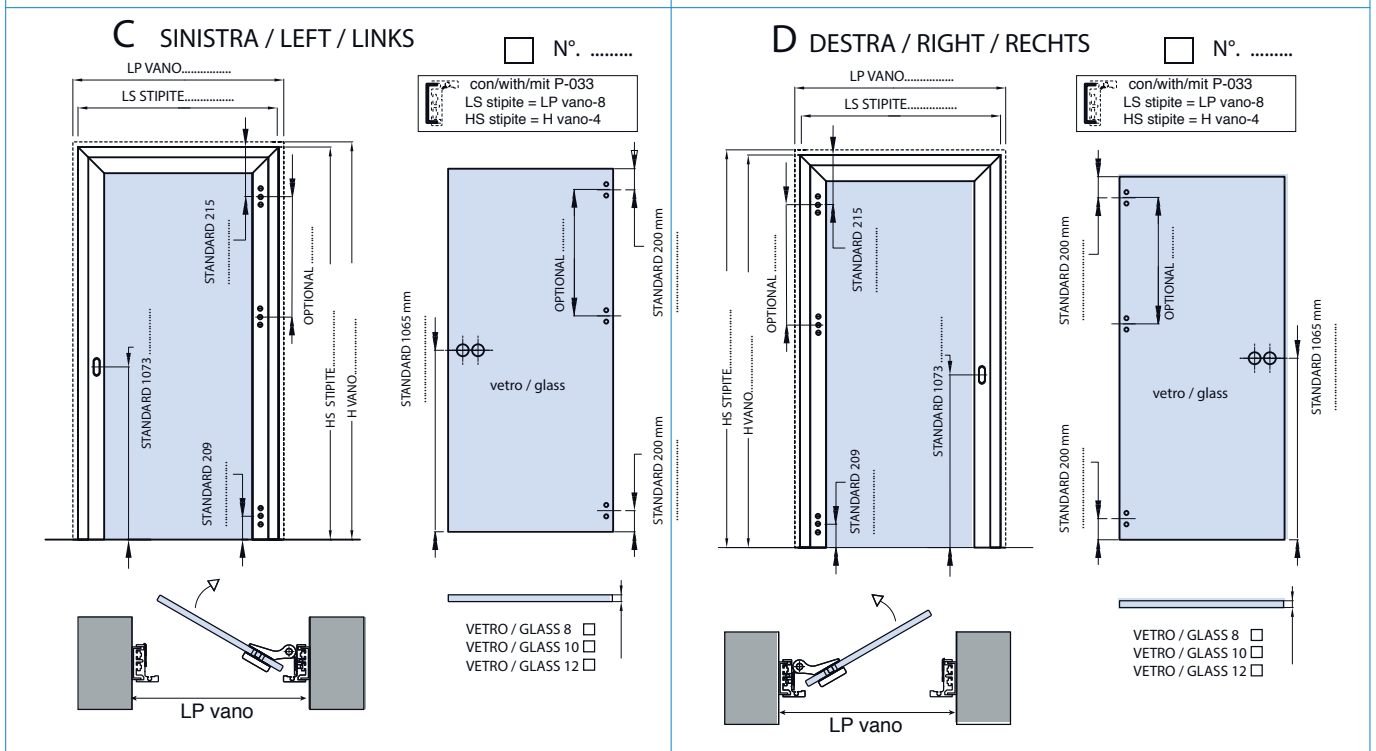
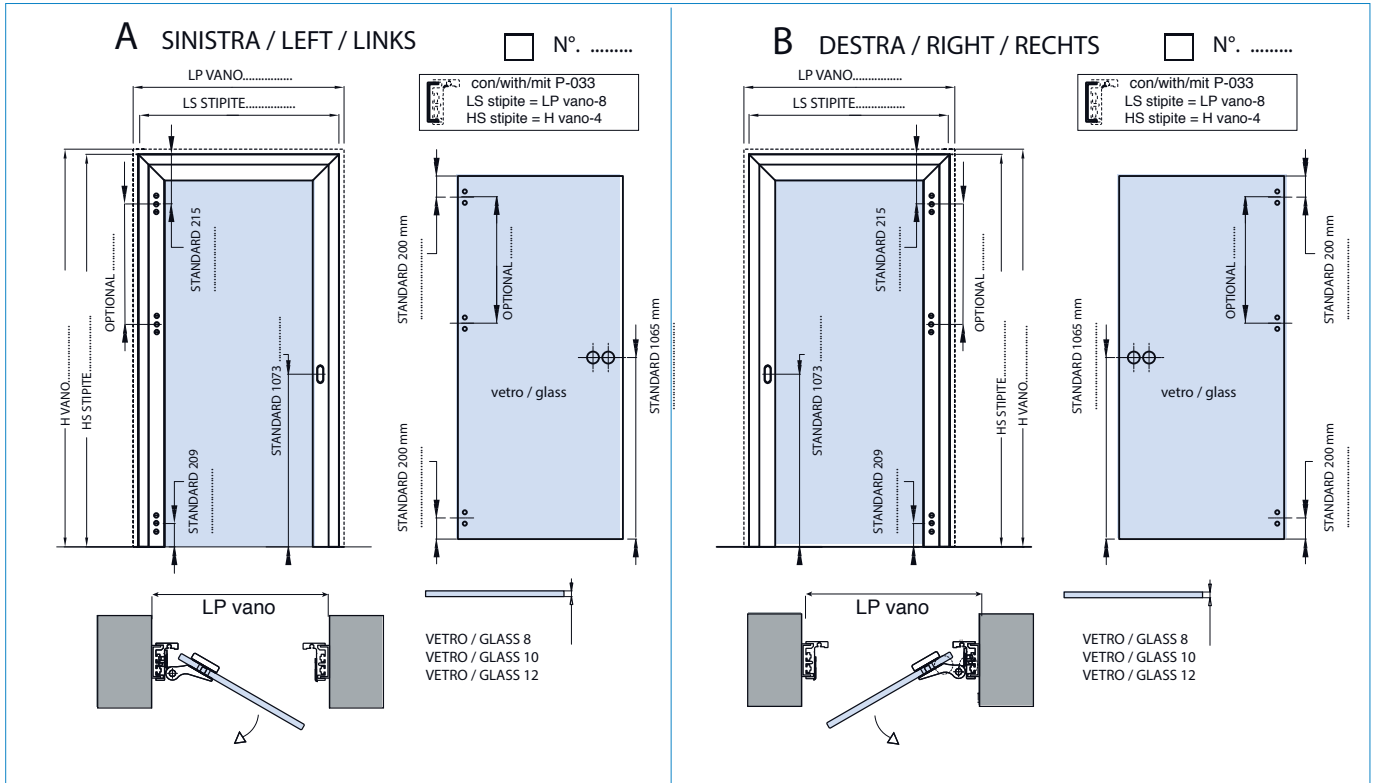

Scegliere serratura, contropiasta e cerniere disponibili - Choose available locks, strike plates and hinges
Wählen Sie die verfügbaren Schlösser, Schliessbleche und Bänder

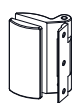

- V-409 / V-509 / V-709 / V-809 / V-909
- V-701 P-09
- V-729 PO-100
- V-704 PO-200
- P-08 V-807

- | | | | |
|----------------|--------------------------|--|----------|
| LAV-030 | <input type="checkbox"/> | Serrature orizzontali e compatte
Horizontal and compacted locks | CP-015 |
| LAV-030-M | <input type="checkbox"/> | Serrature magnetiche orizzontali e compatte
Magnetic horizontal and compacted locks | CP-015-M |
| LAV-030-MV-750 | <input type="checkbox"/> | MV-750 | CP-015-M |
| LAV-030-750 | <input type="checkbox"/> | V-750 | CP-01 |
| LAV-030-780 | <input type="checkbox"/> | V-780 | CP-01 |

xme080-A

HS STIPITE = Altezza stipite
HS STIPITE = Frame profile height
HS STIPITE = Zargenaußenmaß - Höhe

H VANO = Altezza vano
H VANO = Dimension of opening height
H VANO = Lichte Höhe

LS STIPITE = Larghezza stipite
LS STIPITE = Frame profile width
LS STIPITE = Zargenaußenmaß-Breite

LP VANO = Larghezza vano
LP VANO = Dimension of opening width
LP VANO = Lichte Breite

LAV-040 | LAV-040-M

LAVORAZIONE STIPITI P-040 (CON P-033) PER FORI CERNIERA E CONTROPIASTRA SERRATURA - PROFILE PREPARATION P-040 (WITH P-033)
 PROFILBEARBEITUNG P-040 (MIT P-033)

LAVORAZIONI POSSIBILI SONO SOLO STANDARD - ONLY STANDARD PROFILE PREPARATION AVAILABLE
 NUR STANDARD PROFILBEARBEITUNG LIEFERBAR

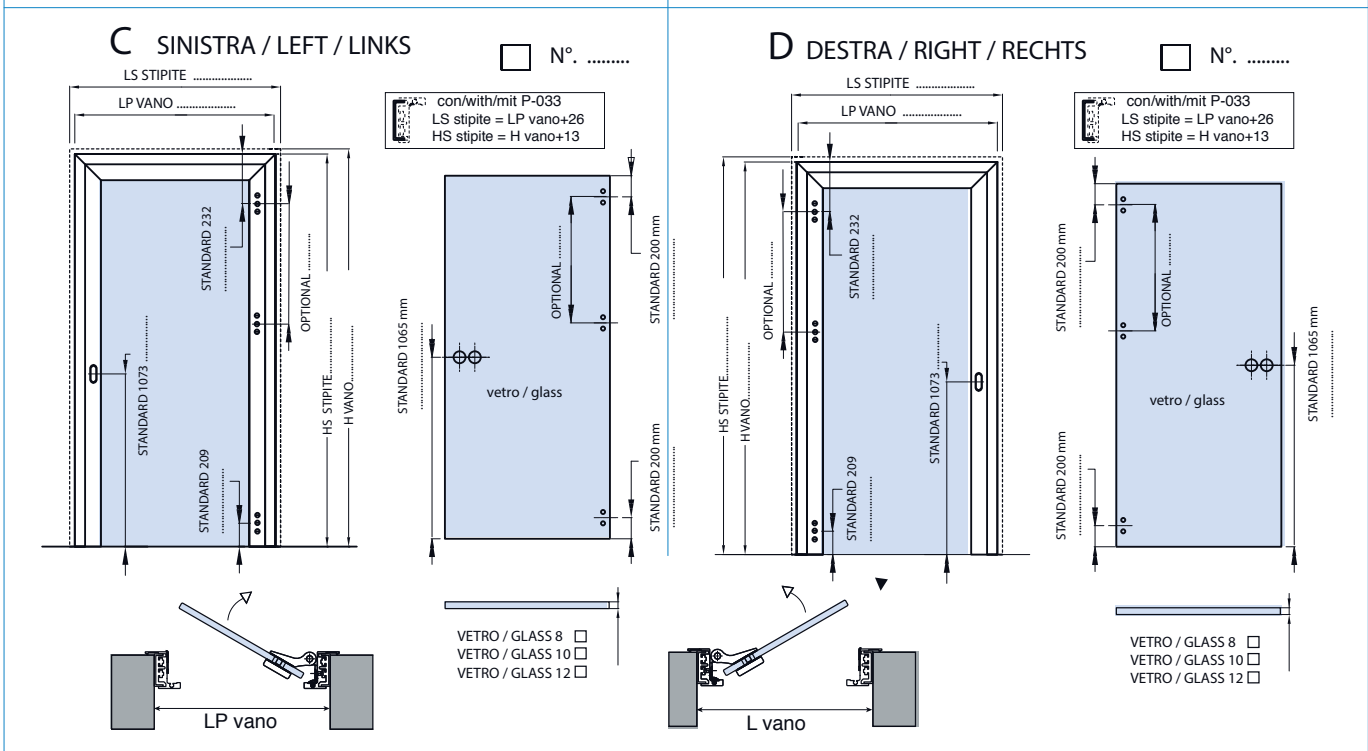
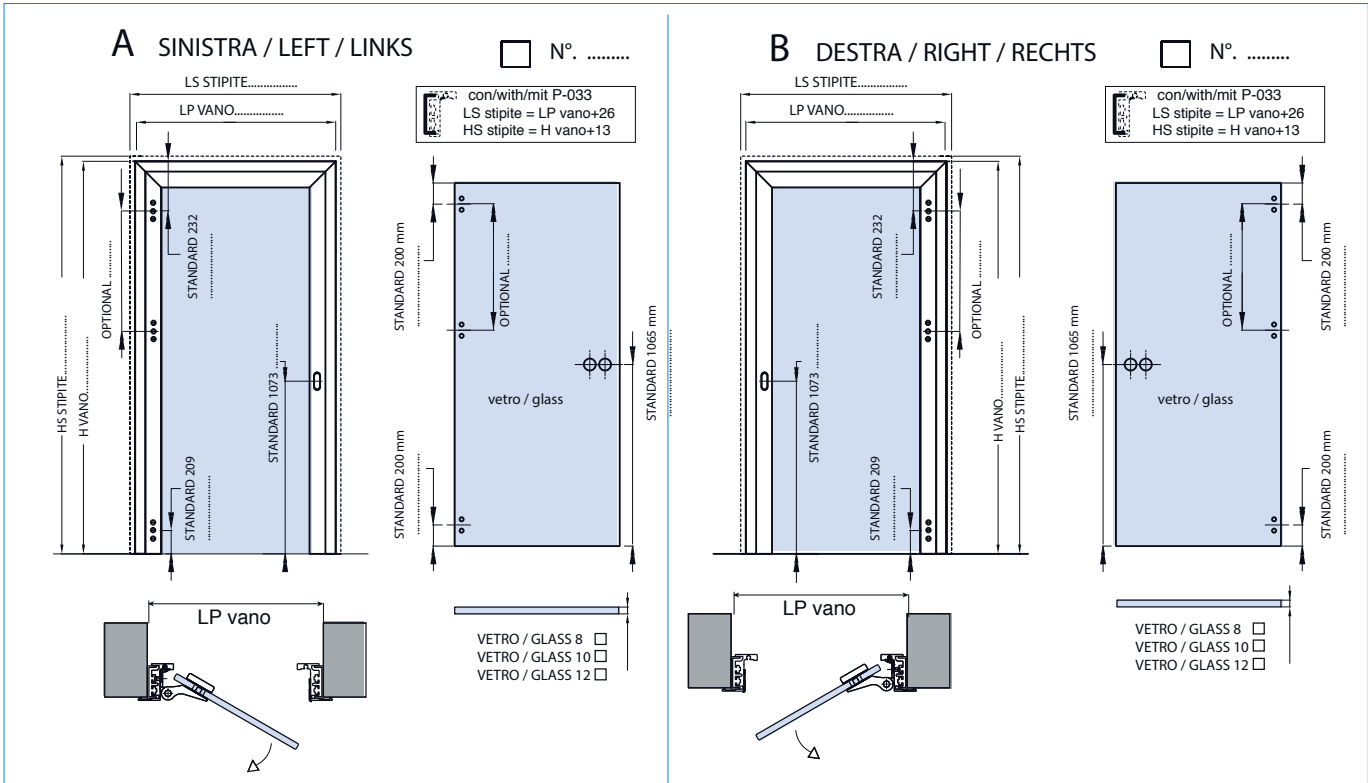

Scegliere serratura, contropiasta e cerniere disponibili - Choose available locks, strike plates and hinges
 Wählen Sie die verfügbaren Schlösser, Schliessbleche und Bänder



- V-409 / V-509 / V-709 / V-809 / V-909
- V-701 P-09
- V-729 PO-100
- V-704 PO-200
- P-08 V-807

- | | | | | | |
|----------------|--------------------------|--|--|--|----------|
| LAV-040 | <input type="checkbox"/> | | Serrature orizzontali e compatte
Horizontal and compacted locks | | CP-015 |
| LAV-040-M | <input type="checkbox"/> | | Serrature magnetiche orizzontali e compatte
Magnetic horizontal and compacted locks | | CP-015-M |
| LAV-040-MV-750 | <input type="checkbox"/> | | MV-750 | | CP-015-M |
| LAV-040-750 | <input type="checkbox"/> | | V-750 | | CP-01 |
| LAV-040-780 | <input type="checkbox"/> | | V-780 | | CP-01 |

xme082-A

HS STIPITE = Altezza stipite
 HS STIPITE = Frame profile height
 HS STIPITE = Zargenaußenmaß - Höhe

H VANO = Altezza vano
 H VANO = Dimension of opening height
 H VANO = Lichte Höhe

LS STIPITE = Larghezza stipite
 LS STIPITE = Frame profile width
 LS STIPITE = Zargenaußenmaß-Breite

LP VANO = Larghezza vano
 LP VANO = Dimension of opening width
 LP VANO = Lichte Breite

LAV-010

LAVORAZIONE STIPITI P-010 CON P-034 PER FORI CERNIERA E CONTROPIASTRA SERRATURA - PROFILE PREPARATION P-010 WITH P-034 - PROFILBEARBEITUNG P-010 MIT P-034

LAVORAZIONI POSSIBILI SONO SOLO STANDARD - ONLY STANDARD PROFILE PREPARATION AVAILABLE
NUR STANDARD PROFILBEARBEITUNG LIEFERBAR

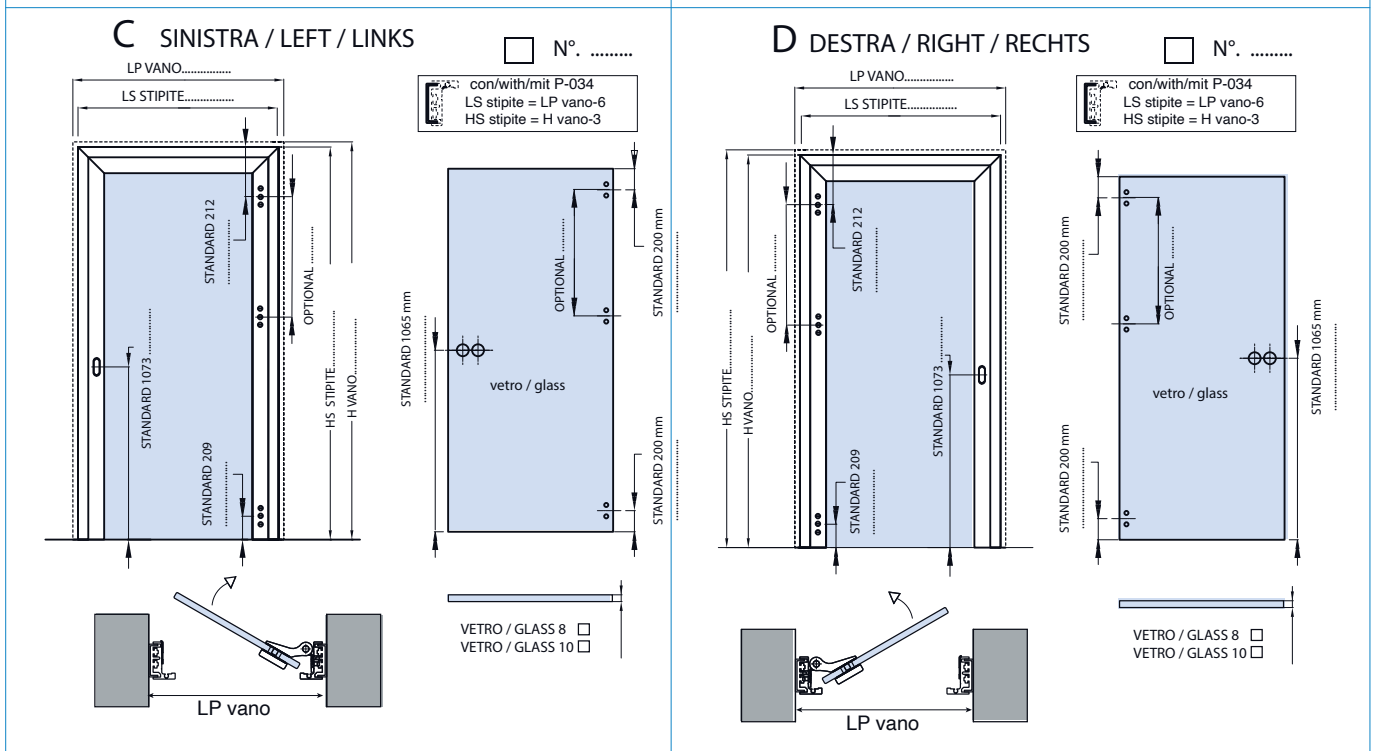
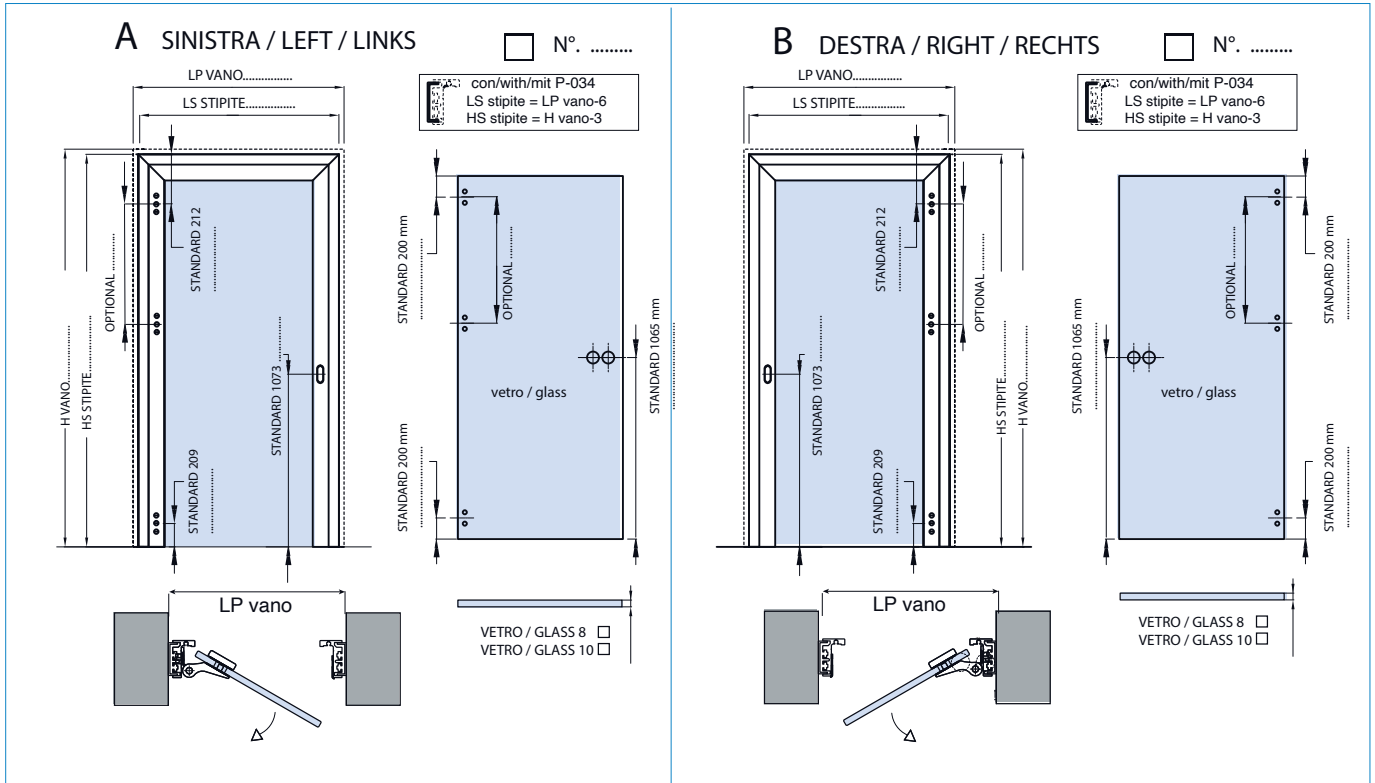

Scegliere serratura, contropiastra e cerniere disponibili - Choose available locks, strike plates and hinges
Wählen Sie die verfügbaren Schlösser, Schliessbleche und Bänder

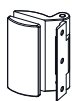

- V-409 / V-509 / V-709 / V-809 / V-909
- V-701
- V-729
- V-704

LAV-010-780



V-780

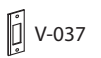

V-037

LAV-010-750



V-750

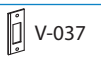

V-037

LAV-010



Serrature orizzontali e compatte
Horizontal and compacted locks

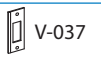

V-037

xme564

HS STIPITE = Altezza stipite
HS STIPITE = Frame profile height
HS STIPITE = Zargenaußenmaß - Höhe

H VANO = Altezza vano
H VANO = Dimension of opening height
H VANO = Lichte Höhe

LS STIPITE = Larghezza stipite
LS STIPITE = Frame profile width
LS STIPITE = Zargenaußenmaß-Breite

LP VANO = Larghezza vano
LP VANO = Dimension of opening width
LP VANO = Lichte Breite

LAV-080 | LAV-080-M

LAVORAZIONE STIPITI P-030 CON P-033 PER FORI CERNIERA E CONTROPIASTRA SERRATURA - PROFILE PREPARATION P-030 WITH P-033 - PROFILBEARBEITUNG P-030 MIT P-033

LAVORAZIONI POSSIBILI SONO SOLO STANDARD - ONLY STANDARD PROFILE PREPARATION AVAILABLE
NUR STANDARD PROFILBEARBEITUNG LIEFERBAR

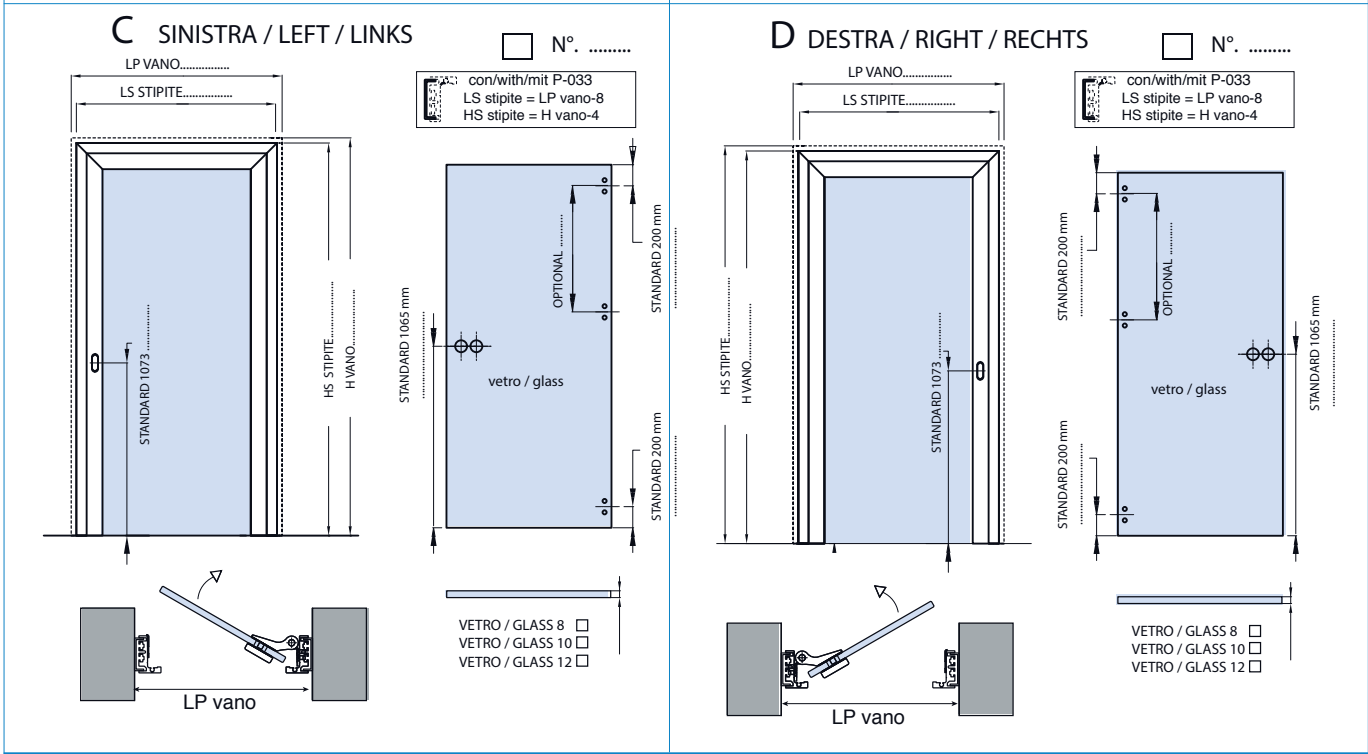
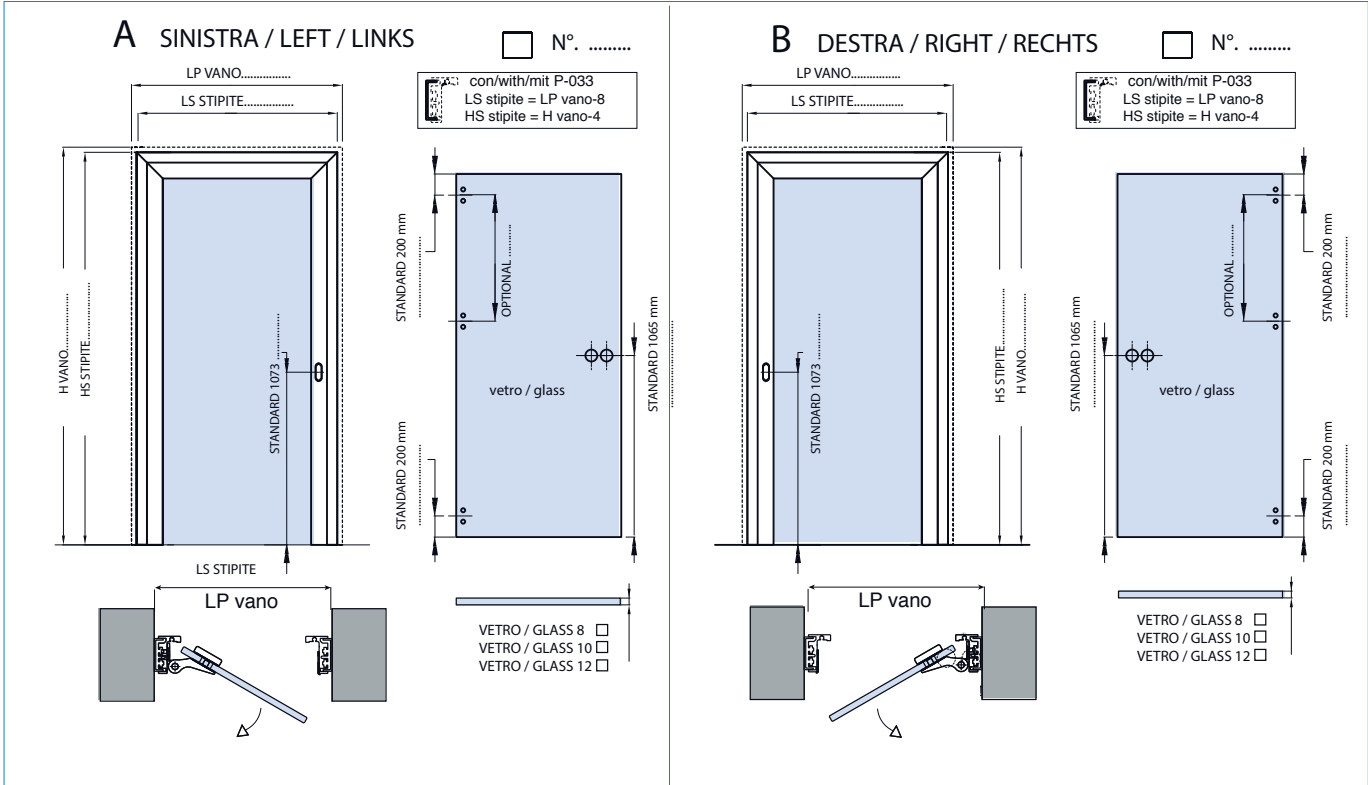

Scegliere serratura, contropiasta e cerniere disponibili - Choose available locks, strike plates and hinges
Wählen Sie die verfügbaren Schlösser, Schliessbleche und Bänder



P-082-CF2 per cerniere/for hinges:
V-409 / V-509 / V-709 / V-809 / V-909

LAV-080

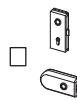

V-750

Serrature orizzontali e compatte
Horizontal and compacted locks



CP-015-80

LAV-080-M



V-750

Serrature magnetiche orizzontali e compatte
Magnetichorizontal and compacted locks



CP-015-80-M

xme563-A

HS STIPITE = Altezza stipite
HS STIPITE = Frame profile height
HS STIPITE = Zargenaußenmaß - Höhe

H VANO = Altezza vano
H VANO = Dimension of opening height
H VANO = Lichte Höhe

LS STIPITE = Larghezza stipite
LS STIPITE = Frame profile width
LS STIPITE = Zargenaußenmaß-Breite

LP VANO = Larghezza vano
LP VANO = Dimension of opening width
LP VANO = Lichte Breite

LAV-TP-300

LAVORAZIONE STIPITI TP-300 PER FORI CERNIERA E CONTROPIASTRA SERRATURA - PROFILE PREPARATION TP-300 - PROFILBEARBEITUNG TP-300
 LAVORAZIONI POSSIBILI SONO SOLO STANDARD - ONLY STANDARD PROFILE PREPARATION AVAILABLE
 NUR STANDARD PROFILBEARBEITUNG LIEFERBAR

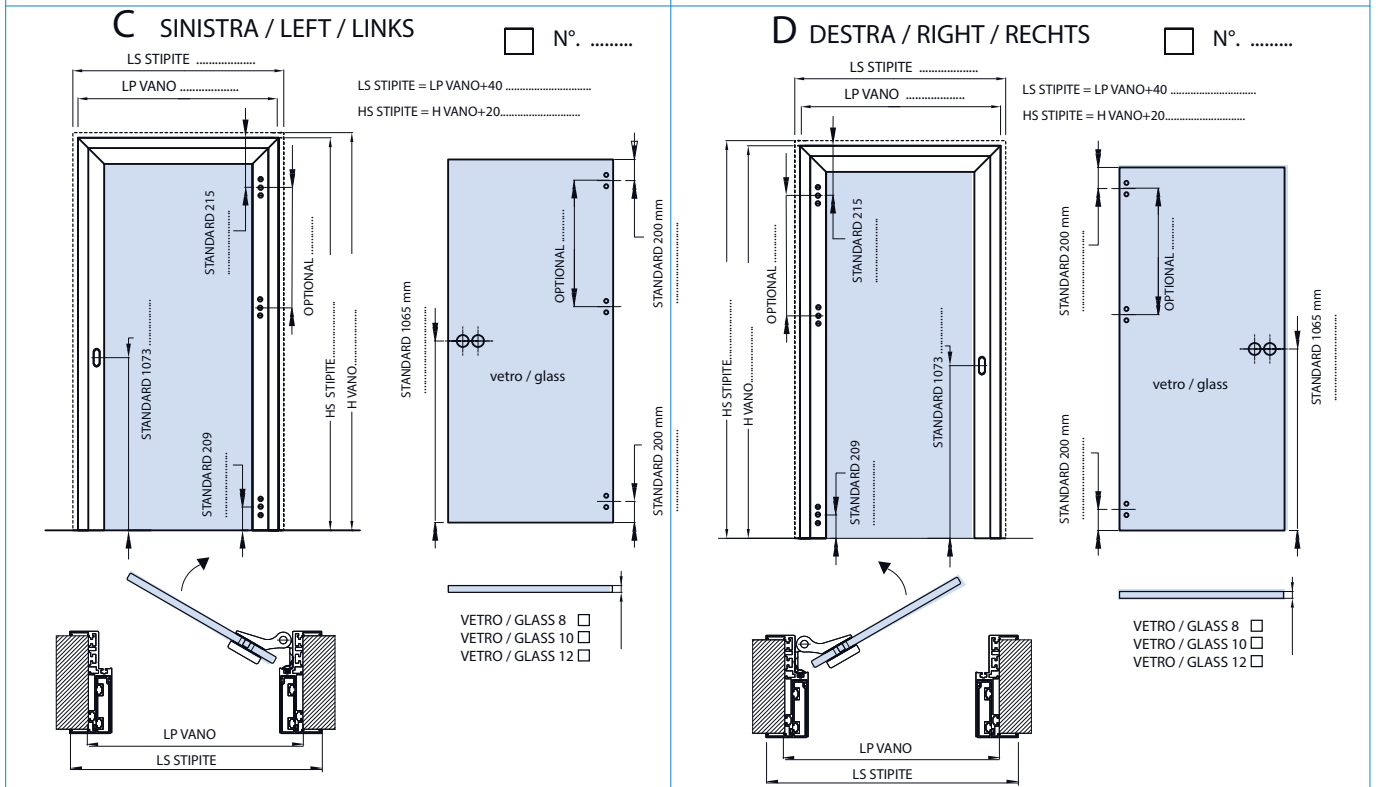
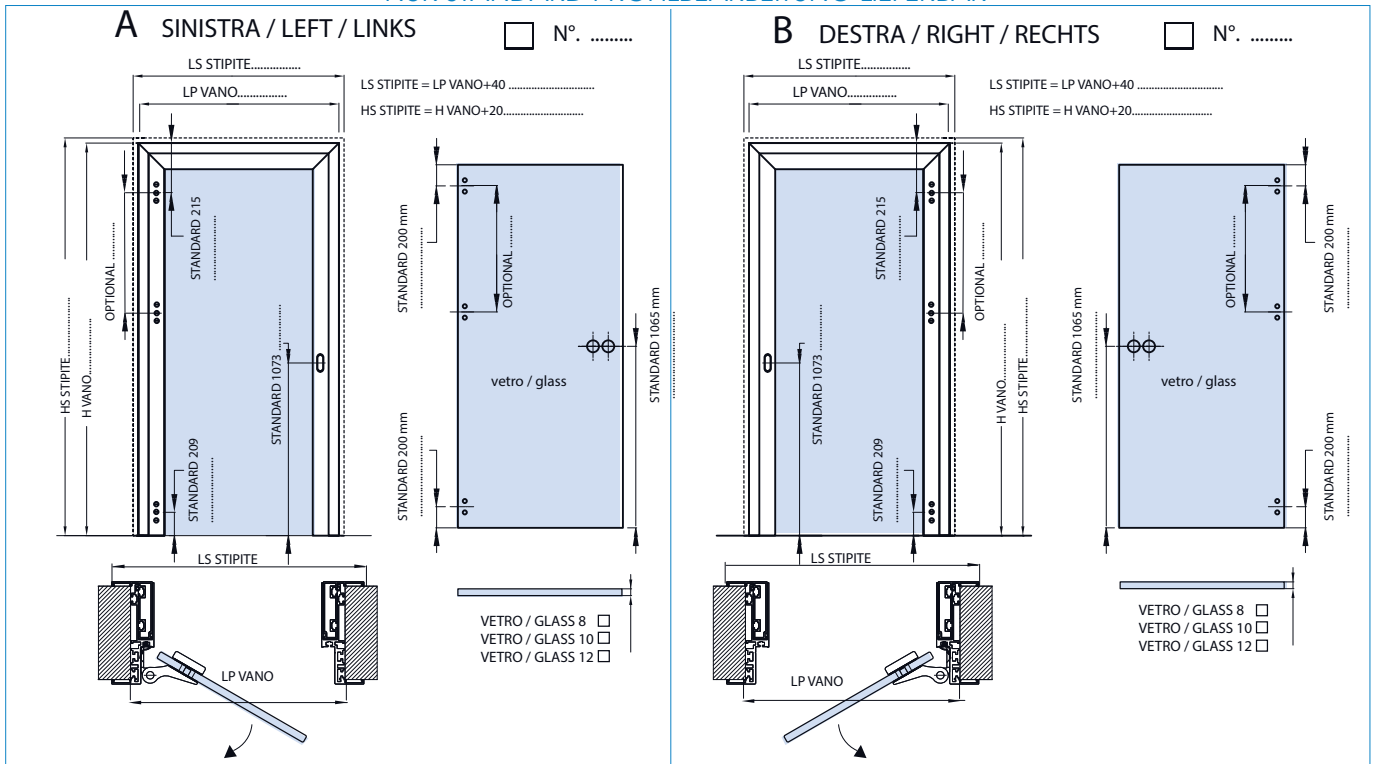

Scegliere serratura, contropiastra e cerniere disponibili - Choose available locks, strike plates and hinges
 Wählen Sie die verfügbaren Schlösser, Schliessbleche und Bänder



- V-409 / V-509 / V-709 / V-809 / V-909
- V-701 P-09
- V-729 PO-100
- V-704 PO-200
- P-08 V-807

LAV-300



Serrature orizzontali e compatte
 Horizontal and compacted locks



CP-015

LAV-300-M



Serrature magnetiche orizzontali e compatte
 Magnetic horizontal and compacted locks

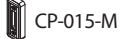

CP-015-M

LAV-300-MV-750



MV-750

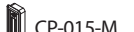

CP-015-M

LAV-300-750



V-750



CP-01

LAV-300-780



V-780



CP-01

xme566

HS STIPITE = Altezza stipite
 HS STIPITE = Frame profile height
 HS STIPITE = Zargenaußenmaß - Höhe

H VANO = Altezza vano
 H VANO = Dimension of opening height
 H VANO = Lichte Höhe

LS STIPITE = Larghezza stipite
 LS STIPITE = Frame profile width
 LS STIPITE = Zargenaußenmaß-Breite

LP VANO = Larghezza vano
 LP VANO = Dimension of opening width
 LP VANO = Lichte Breite

LAV-100

LAVORAZIONE STIPITI TP-100 PER FORI CERNIERA E CONTROPIASTRA SERRATURA - PROFILE PREPARATION TP-100 - PROFILBEARBEITUNG TP-100

LAVORAZIONI POSSIBILI SONO SOLO STANDARD - ONLY STANDARD PROFILE PREPARATION AVAILABLE
NUR STANDARD PROFILBEARBEITUNG LIEFERBAR

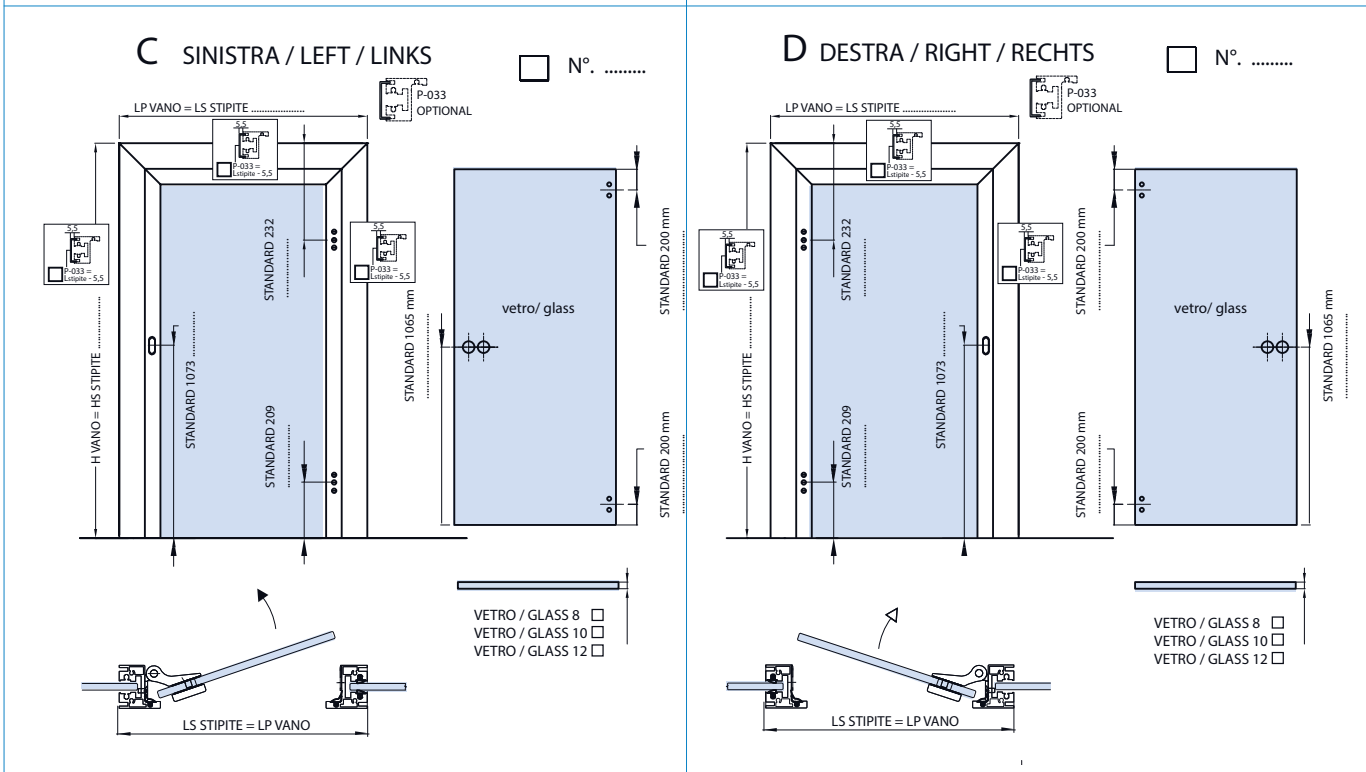
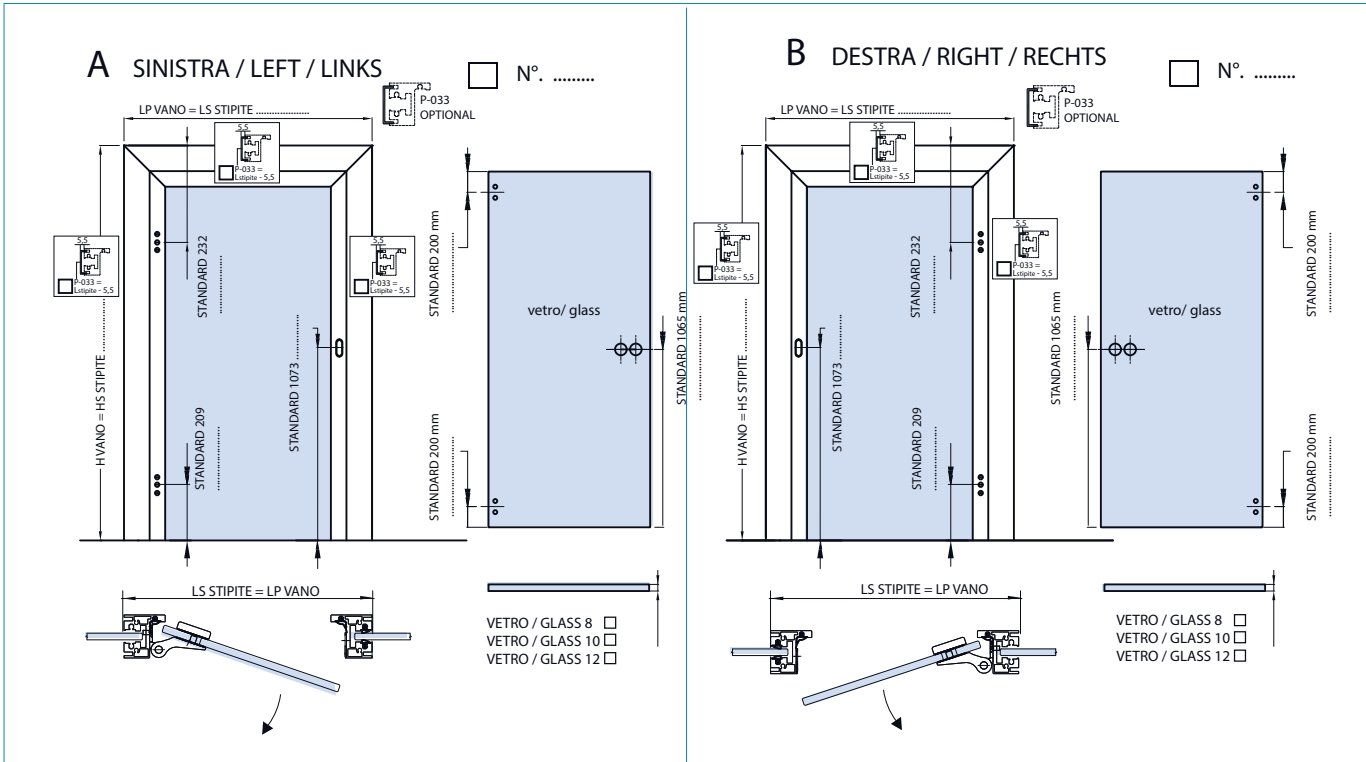

Scegliere serratura, contropiasta e cerniere disponibili - Choose available locks, strike plates and hinges
Wählen Sie die verfügbaren Schösser, Schliessbleche und Bänder



- V-409 V-509 V-709 V-809 V-909
- V-701 P-09
- V-729 PO-100
- V-704 PO-200
- P-08 V-807

LAV-100



Serrature orizzontali e compatte
Horizontal and compacted locks

CP-015

LAV-100-M



Serrature magnetiche orizzontali e compatte
Magnetic horizontal and compacted locks

CP-015-M

LAV-100-MV-750



MV-750

CP-015-M

LAV-100-750



V-750

CP-01

LAV-100-780



V-780

CP-01

xme565

H STIPITE = Altezza stipite
H STIPITE = Frame profile height
H STIPITE = Zargenaußenmaß - Höhe

H VANO = Altezza vano
H VANO = Dimension of opening height
H VANO = Lichte Höhe

L STIPITE = Larghezza stipite
L STIPITE = Frame profile width
L STIPITE = Zargenaußenmaß-Breite

L VANO = Larghezza vano
L VANO = Dimension of opening width
L VANO = Lichte Breite

LAV-200

LAVORAZIONE STIPITI TP-200 PER FORI CERNIERA E CONTROPIASTRA SERRATURA - PROFILE PREPARATION TP-200 - PROFILBEARBEITUNG TP-200
 LAVORAZIONI POSSIBILI SONO SOLO STANDARD - ONLY STANDARD PROFILE PREPARATION AVAILABLE
 NUR STANDARD PROFILBEARBEITUNG LIEFERBAR

A SINISTRA / LEFT / LINKS

N°.

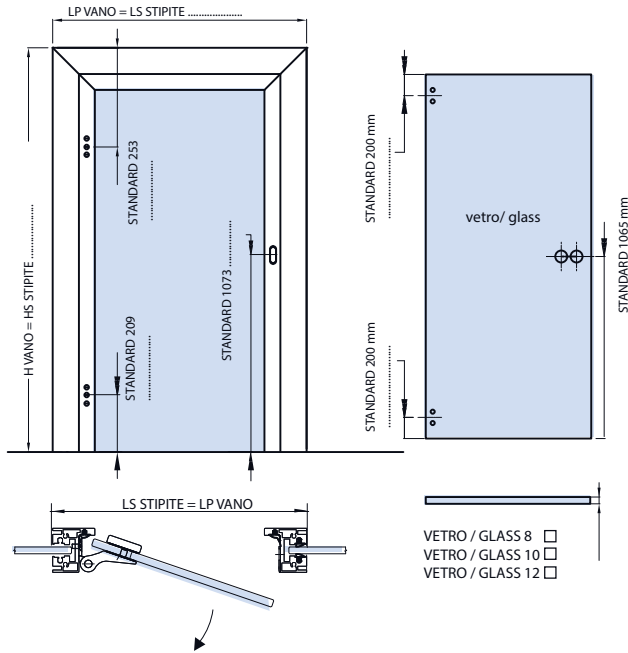

B DESTRA / RIGHT / RECHTS

N°.

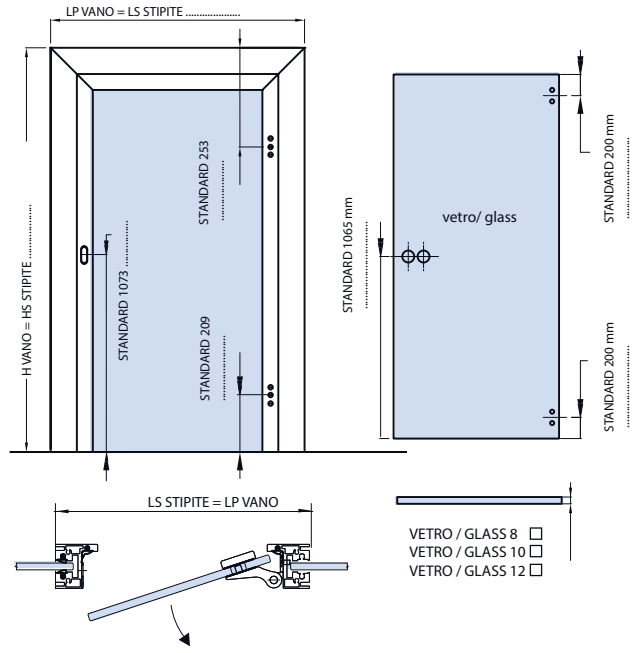

C SINISTRA / LEFT / LINKS

N°.

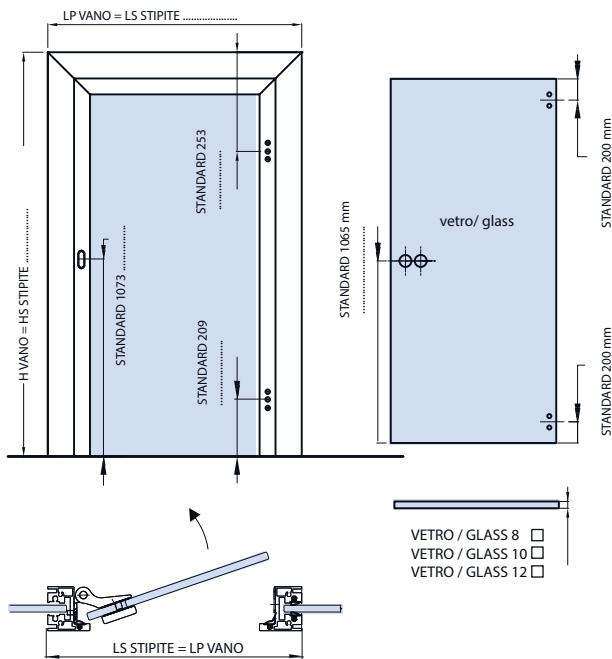

D DESTRA / RIGHT / RECHTS

N°.

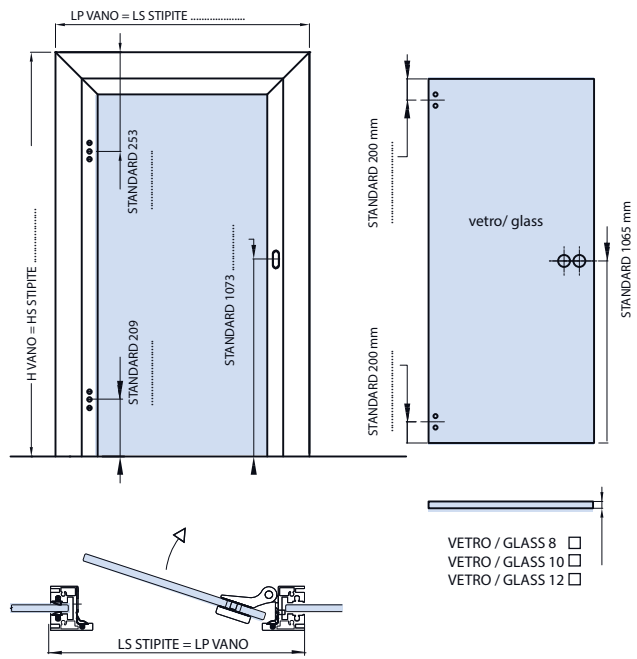

Scegliere serratura, contropiastra e cerniere disponibili - Choose available locks, strike plates and hinges
 Wählen Sie die verfügbaren Schlösser, Schliessbleche und Bänder



- V-409 / V-509 / V-709 / V-809 / V-909
- V-701 P-09
- V-729 PO-100
- V-704 PO-200
- P-08 V-807

- | | | | | | |
|----------------|--------------------------|--|--|--|----------|
| LAV-200 | <input type="checkbox"/> | | Serrature orizzontali e compatte
Horizontal and compacted locks | | CP-015 |
| LAV-200-M | <input type="checkbox"/> | | Serrature magnetiche orizzontali e compatte
Magnetic horizontal and compacted locks | | CP-015-M |
| LAV-200-MV-750 | <input type="checkbox"/> | | MV-750 | | CP-015-M |
| LAV-200-750 | <input type="checkbox"/> | | V-750 | | CP-01 |
| LAV-200-780 | <input type="checkbox"/> | | V-780 | | CP-01 |

xme565-b

H STIPITE = Altezza stipite
 H STIPITE = Frame profile height
 H STIPITE = Zargenaußenmaß - Höhe

H VANO = Altezza vano
 H VANO = Dimension of opening height
 H VANO = Lichte Höhe

L STIPITE = Larghezza stipite
 L STIPITE = Frame profile width
 L STIPITE = Zargenaußenmaß-Breite

L VANO = Larghezza vano
 L VANO = Dimension of opening width
 L VANO = Lichte Breite

LAV-110

LAVORAZIONE STIPITI TP-110 PER FORI CERNIERA E CONTROPIASTRA SERRATURA - PROFILE PREPARATION TP-110 - PROFILBEARBEITUNG TP-110

LAVORAZIONI POSSIBILI SONO SOLO STANDARD - ONLY STANDARD PROFILE PREPARATION AVAILABLE
NUR STANDARD PROFILBEARBEITUNG LIEFERBAR

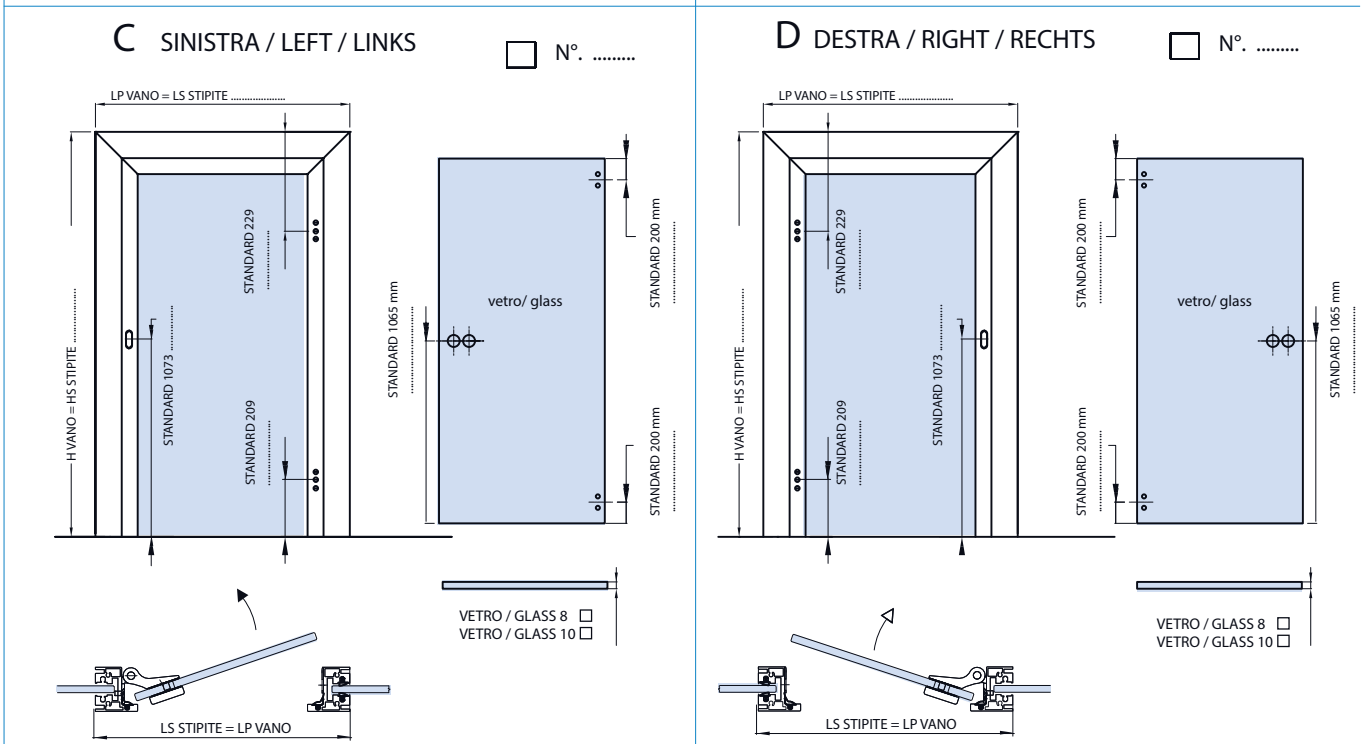
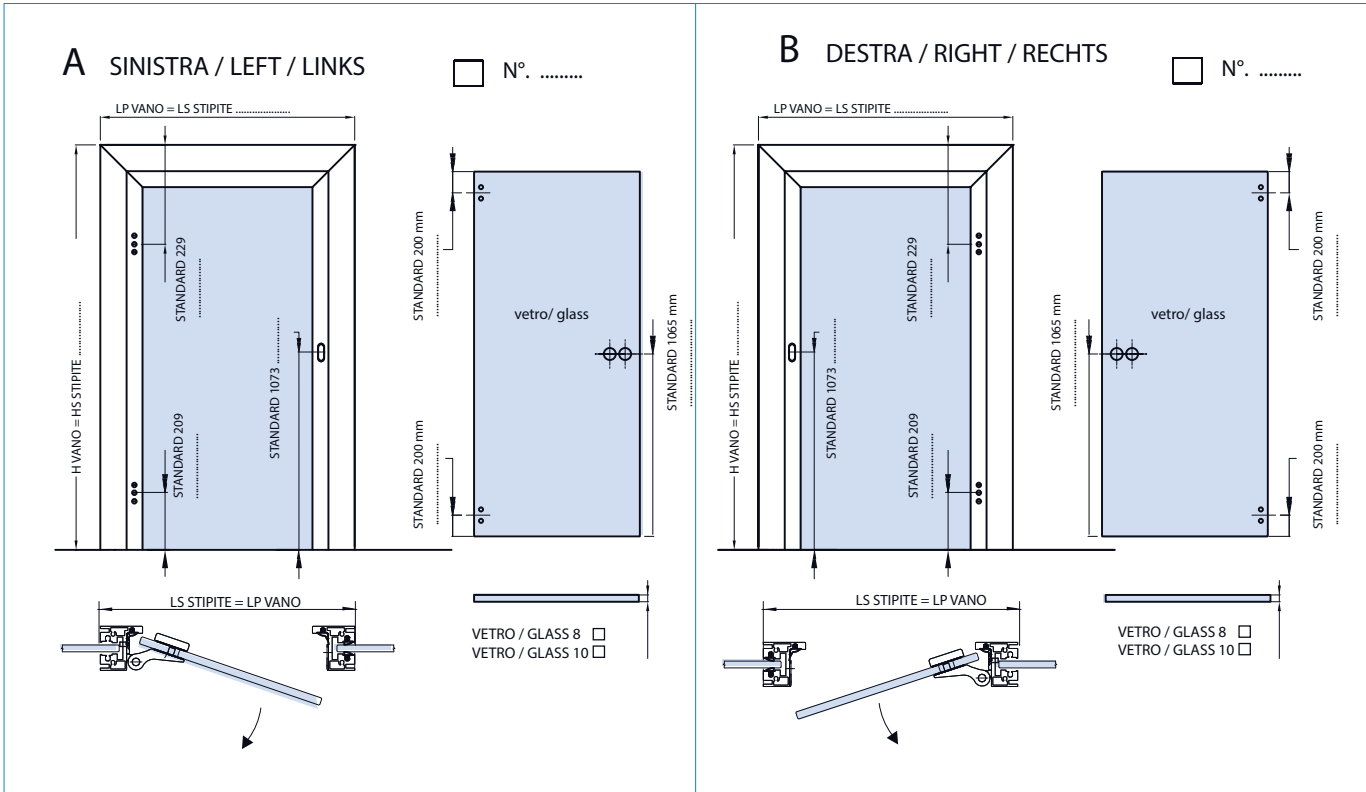

Scegliere serratura, contropiastra e cerniere disponibili - Choose available locks, strike plates and hinges
Wählen Sie die verfügbaren Schlösser, Schliessbleche und Bänder

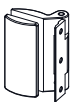

- V-409 / V-509 / V-709 / V-809 / V-909
- V-701
- V-729
- V-704

LAV-110-780



V-780



V-037

LAV-110-750



V-750



V-037

LAV-110



Serrature orizzontali e compatte
Horizontal and compacted locks



V-037

xme565-c

H STIPITE = Altezza stipite
H STIPITE = Frame profile height
H STIPITE = Zargenaußenmaß - Höhe

H VANO = Altezza vano
H VANO = Dimension of opening height
H VANO = Lichte Höhe

L STIPITE = Larghezza stipite
L STIPITE = Frame profile width
L STIPITE = Zargenaußenmaß-Breite

L VANO = Larghezza vano
L VANO = Dimension of opening width
L VANO = Lichte Breite

LAV-060

LAVORAZIONE STIPITI P-040 (CON P-033) PER FORI CERNIERA E CONTROPIASTRA SERRATURA - PROFILE PREPARATION P-060 - PROFILBEARBEITUNG P-060

LAVORAZIONI POSSIBILI SONO SOLO STANDARD - ONLY STANDARD PROFILE PREPARATION AVAILABLE
NUR STANDARD PROFILBEARBEITUNG LIEFERBAR

A P-060 stipite rasomuro a tirare
Alu-frame opening to pull
Aluzarge nach aussen öffnend N°.

LS STIPITE = LP VANO+66+66
HS STIPITE = HP VANO+66

SINISTRA - LEFT - LINKS

- a muro | to the wall | zum einmauern
 cartongesso | plaster | Gipskarton

	Passaggio luce Passage clearance Durchgang		Ingombro stipiti Jamb dimensions Rahmengrößen	
	LP Larghezza Breite	HP Altezza Höhe	LS Larghezza Breite	HS Altezza Höhe
<input checked="" type="checkbox"/>	700	2100	832	2166
<input type="checkbox"/>	800	2100	932	2166
<input type="checkbox"/>	900	2100	1032	2166

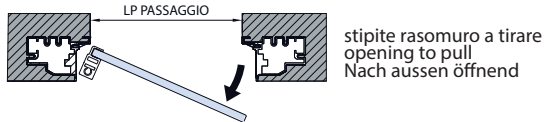
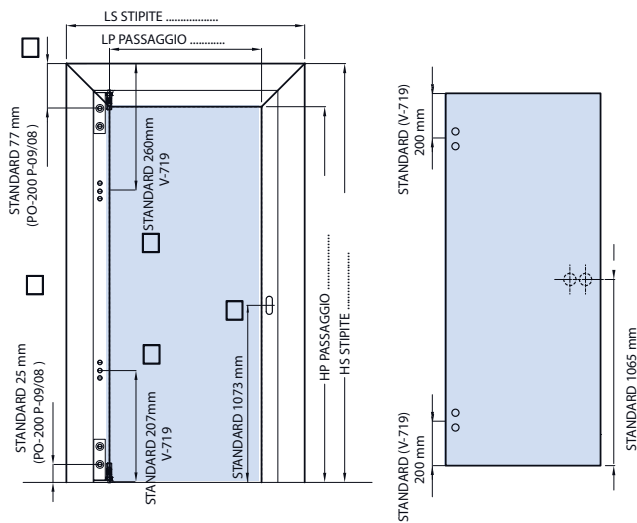

B P-060 stipite rasomuro a tirare
Alu-frame opening to pull
Aluzarge nach aussen öffnend N°.

LS STIPITE = LP VANO+66+66
HS STIPITE = HP VANO+66

DESTRA - RIGHT - RECHTS

- a muro | to the wall | zum einmauern
 cartongesso | plaster | Gipskarton

	Passaggio luce Passage clearance Durchgang		Ingombro stipiti Jamb dimensions Rahmengrößen	
	LP Larghezza Breite	HP Altezza Höhe	LS Larghezza Breite	HS Altezza Höhe
<input checked="" type="checkbox"/>	700	2100	832	2166
<input type="checkbox"/>	800	2100	932	2166
<input type="checkbox"/>	900	2100	1032	2166

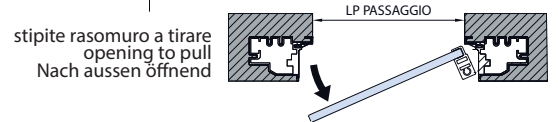
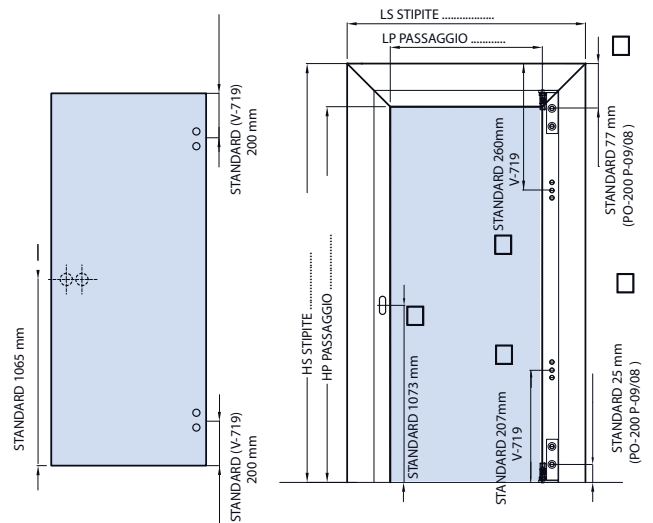

Cerniere - Hinges - Bänder

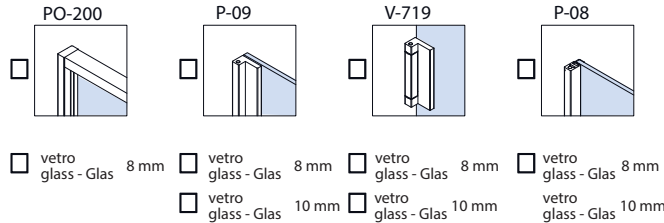

Cerniere - Hinges - Bänder

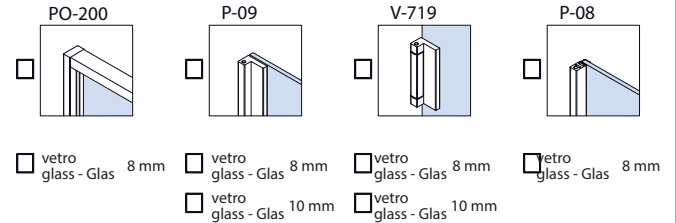

Serrature e contropiastre - Locks and strike plates - Schlösser und Schliessbleche

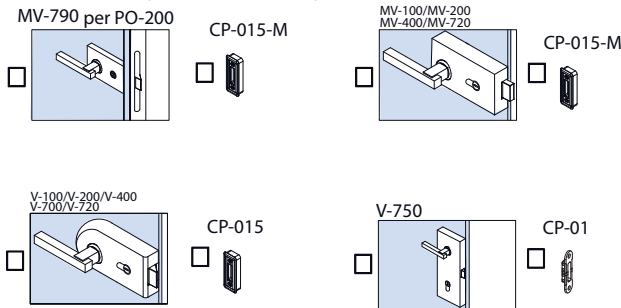

Serrature e contropiastre - Locks and strike plates - Schlösser und Schliessbleche

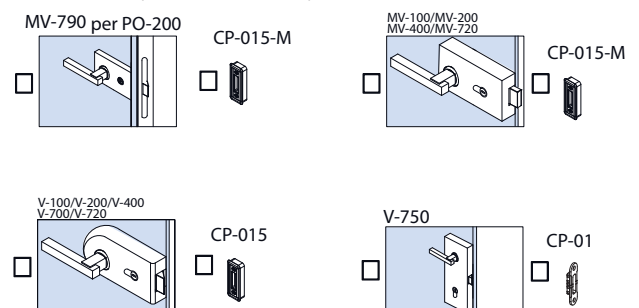

xme284-A

HS = Altezza stipite
Frame profile height
Zargenaußenmaß - Höhe

HP = Altezza passaggio luce
Clear opening height
Lichte Durchgangshöhe

LS = Larghezza stipite
Frame profile width
Zargenaußenmaß-Breite

LP = Passaggio luce
Clear opening width
Lichte Durchgangsbreite

LAV-070

LAVORAZIONE STIPITI P-040 (CON P-033) PER FORI CERNIERA E CONTROPIASTRA SERRATURA - PROFILE PREPARATION P-070 - PROFILBEARBEITUNG P-070

LAVORAZIONI POSSIBILI SONO SOLO STANDARD - ONLY STANDARD PROFILE PREPARATION AVAILABLE
NUR STANDARD PROFILBEARBEITUNG LIEFERBAR

A P-070 stipite rasomuro a spingere
Alu-frame opening to push
Aluzarge nach innen öffend

N°.

LS STIPITE = LP VANO+62.5+62.5
HS STIPITE = HP VANO+62.5

SINISTRA - LEFT - LINKS

- a muro | to the wall | zum einmauern
 cartongesso | plaster | Gipskarton

✓	Passaggio luce Passage clearance Durchgang		Ingombro stipiti Jamb dimensions Rahmengrößen	
	LP	HP	LS	HS
<input type="checkbox"/>	700	2100	825	2163
<input type="checkbox"/>	800	2100	925	2163
<input type="checkbox"/>	900	2100	1025	2163

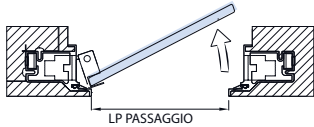
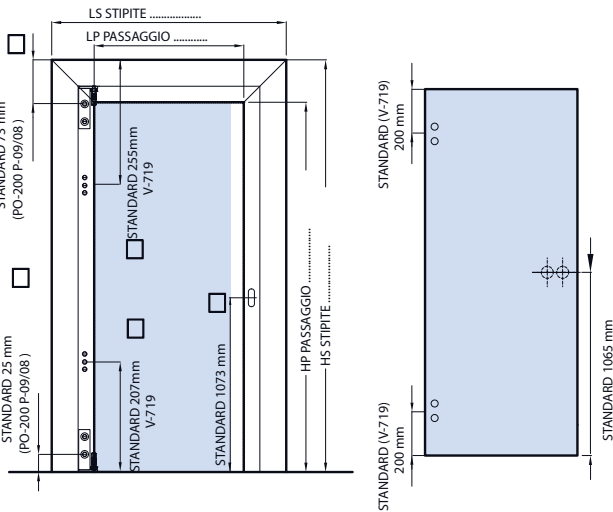

stipite rasomuro a spingere
opening to push
Nach innen öffend

B P-070 stipite rasomuro a spingere
Alu-frame opening to push
Aluzarge nach innen öffend

DESTRA - RIGHT - RECHTS

- a muro | to the wall | zum einmauern
 cartongesso | plaster | Gipskarton

✓	Passaggio luce Passage clearance Durchgang		Ingombro stipiti Jamb dimensions Rahmengrößen	
	LP	HP	LS	HS
<input type="checkbox"/>	700	2100	825	2163
<input type="checkbox"/>	800	2100	925	2163
<input type="checkbox"/>	900	2100	1025	2163

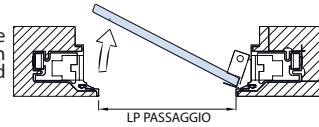
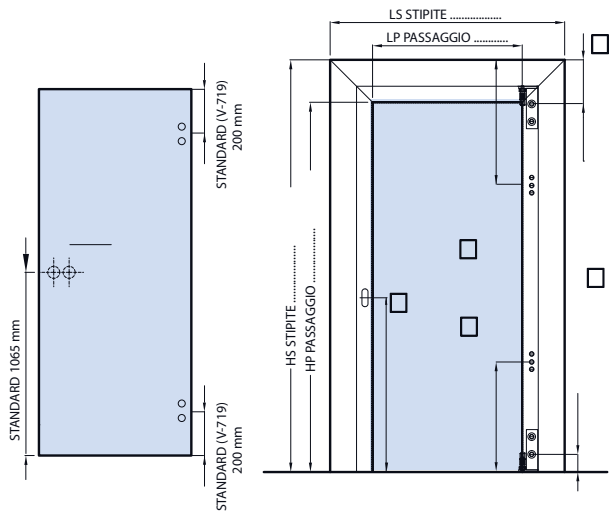

stipite rasomuro a spingere
opening to push
Nach innen öffend

Cerniere - Hinges - Bänder

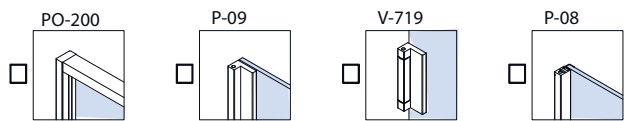

- vetro glass - Glas 8 mm vetro glass - Glas 8 mm vetro glass - Glas 8 mm vetro glass - Glas 8 mm
- vetro glass - Glas 10 mm vetro glass - Glas 10 mm

Serrature e contropiastre - Locks and strike plates - Schlösser und Schliessbleche

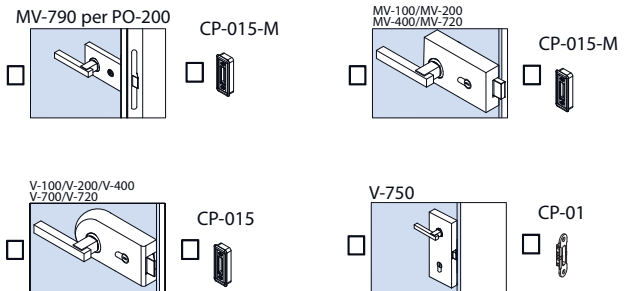

Cerniere - Hinges - Bänder

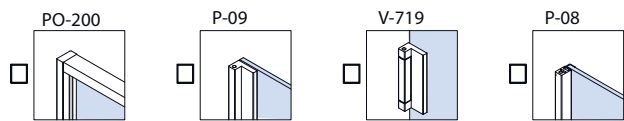

- vetro glass - Glas 8 mm vetro glass - Glas 8 mm vetro glass - Glas 8 mm vetro glass - Glas 8 mm
- vetro glass - Glas 10 mm

Serrature e contropiastre - Locks and strike plates - Schlösser und Schliessbleche

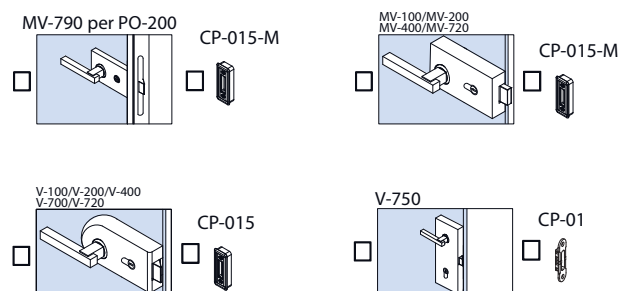

XME 284-B

HS = Altezza stipite
Frame profile height
Zargenaußenmaß - Höhe

HP = Altezza passaggio luce
Clear opening height
Lichte Durchgangshöhe

LS = Larghezza stipite
Frame profile width
Zargenaußenmaß-Breite

LP = Passaggio luce
Clear opening width
Lichte Durchgangsbreite

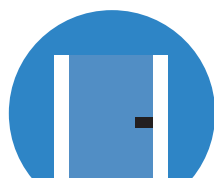

METALGLAS

B O N O M I

ITALY

METALGLAS BONOMI Srl

Via Montini, 106/A

25065 Lumezzane S.A.

(Brescia) Italy

Ph. +39.030.829910

Fax +39.030.8920970

www.metalglas.it - info@metalglas.it



**INTERAGISCI
CON NOI**